

THERMA TRU[®]
DOORS | Where Home Begins[™]



2022 Full-Line Catalog

Building Professionals' Entry & Patio Door Directory



Therma-Tru. Where home begins.

Choosing a Therma-Tru® door means designing an inspired entrance with the confidence that it will perform for years to come.

Whether it's Classic or Contemporary – or somewhere in between – Therma-Tru offers a wide selection to complement the architecture of a home and a homeowner's sense of style.

But it's more than beauty that makes Therma-Tru the brand builders and remodelers prefer most.* With a complete door system engineered with craftsman precision and backed by more than 60 years of industry experience, you can be confident that it will perform as exceptionally as it looks.

That's where the beauty of choosing Therma-Tru begins.

*Brand Use Studies, 2021 *Builder* and 2019 *Remodeling* magazines.

Top: Classic Craft Fir Grain, Satin Etch Glass with SDLs, Doors – CCA82360, Finish – Rustic Clay

Right Page: Fiber-Classic Mahogany Collection, Chinchilla Glass with SDLs, Door – FCM4814XJ, Finish – Raven

Table of Contents



Uncompromising
quality, inside and out.

Your favorite doors – reorganized.

Throughout the catalog you'll find doors organized by glass shape (largest to smallest), followed by glass design, and then texture.

Introduction	2–45
2022 Trends	4–9
NEW Products	10–16
Curb Appeal	17, 20–21
Door Selections	18–19, 22–23
Door System Components	24–25
Tru-Defense®	26–27
Safety & Security	28–29
Decorative & Specialty Glass	30–35
Impact-Rated Products	36–37
Patio, Storm & Vent	38–45
Hinged Patio Door Systems	40–41
Retractable Screen Doors	42–43
Impressions™ Integrated Storm & Entry Door System	44–45
Classic Craft®	46–127
Decorative & Specialty Glass	60–69
Accessories	70–71
Hinged Patio Doors	124–127
Fiber-Classic® & Smooth-Star®	128–227
Decorative & Specialty Glass	134–141
Accessories	142
Hinged Patio Doors	222–227
Steel	228–253
Profiles™	230, 233–247
Traditions	230, 248–253
Decorative & Specialty Glass	231–232
Fire Doors	254–259
Pulse®	260–273
Finish Options	274–278
PrismaGuard® Stain & Paint	274–277
Same-Day® Stain Kit	278
Door System Components	279–293
Special Quote Program	294
3'6" Width Options Chart	295
7'0" & 6'6" Height Options Charts	296–297
Product Details	298–299
Index	300–314
Trade Resources	315

CASUAL HAVEN

HOME TRENDS

Casual Haven

Modern Revival

Renewed History



Natural Light

Simplified

Serene

Gentle





Organic Textures

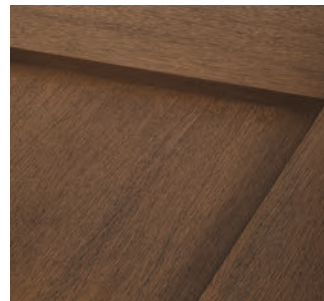

Calming Environment



Familiar Roots

MODERN REVIVAL

HOME TRENDS

Casual Haven

Modern Revival

Renewed History



Material Mixing

Retro

Textural

Streamlined

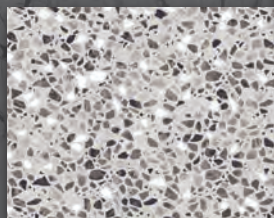



Warm Minimalism



Modern Nature



Fresh Eclectic

renewed HISTORY

HOME TRENDS

Casual Haven

Modern Revival

Renewed History



Heritage Architecture

Dressy

Elevated

Classic

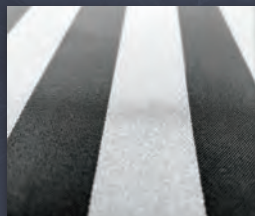



Textured Materials



Relaxed Refinement

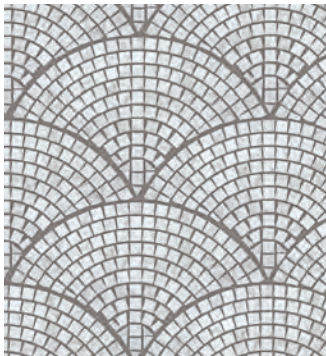

Elegant Comfort

NEW

Mahogany-Grained Flush-Glazed Doors & Sidelites

For Classic Craft®, Artíssa, Founders & Visionary Collections



522



A fresh aesthetic with versatile appeal.

Whether casual, traditional or modern, new Classic Craft® Mahogany-grained 3/4-lite flush-glazed doors bring an updated look to virtually any home. Available with a variety of glass options, starting on page 82.



EnLiten™ Flush-Glazed Riders
for Construction & Installation, and Homeowners

Note: See your Thermo-Tru seller or visit thermatru.com for details on available product sizes and options, limited warranties and exclusions, and Riders.

Left: Classic Craft Mahogany Grain, Homeward Glass, Door – CCM82801, Finish – Barley

Top Right: Classic Craft Mahogany Grain, Satin Etch Glass with SDLs, Door – CCM2812XE, Finish – Acorn

NEW Shaker-Style Entry Door Options

for Fiber-Classic® Mahogany Collection™ & Smooth-Star®



NEW Flush-Glazed Saratoga™ Decorative Glass

for Fiber-Classic® Mahogany Collection™ & Smooth-Star®

Elevate the entry with handcrafted appeal. Shaker-style Craftsman doors and sidelites are now available with flush-glazed Saratoga decorative glass.

Available in Fiber-Classic and Smooth-Star, starting on page 210.



*To confirm code requirements in your jurisdiction, always check with your local building code authority.

**Available for full-lite sidelites only.

Note: Fiber-Classic and Smooth-Star products used in multi-family or commercial settings are backed by a 3-year limited warranty. See your Therma-Tru seller or visit www.thermatru.com for details on available product sizes and options, limited warranties and exclusions, Riders, ENERGY STAR qualified products, product approvals and installation instructions. Please verify that there is a Therma-Tru product approval for the configuration before buying.

Top: Fiber-Classic Mahogany Collection, Saratoga Glass, Door – FCM6240, Sidelites – FCM6201SL, Transom – 19750T, Finish – Sweet Date
Right Page: Smooth-Star, Chord Glass with SDLs, Door – S4813XC, Sidelites – S2000XCSL, Finish – Onyx

NEW 7'0" Shaker-Style Options for Smooth-Star®

Our assortment of popular Shaker-style looks expands to include 7'0" heights, bringing this on-trend design to more homes. The new 7'0" Craftsman Shaker-style door also features an elevated bottom rail for ADA applications.*

Available in Smooth-Star, starting on page 210.

Available Door & Sidelite



Available Glass Options



NEW Saratoga Satin Etch (XE) Chord (XC) Chinchilla (XJ)



Rainglass (XR) Granite (XN) Low-E

Additional Sidelite Glass Options



Reeded (XK)** Geometric (XG)**

Available Glass Shapes & SDL Patterns



Glass Shapes with GBG Patterns



EnLiten™ Flush-Glazed Warranty Riders

See page 33 for details on the EnLiten™ Flush-Glazed Rider for Construction & Installation, and the EnLiten™ Flush-Glazed Rider for Homeowners.



Residential



Commercial & Multi-Resident



NEW 8'0" Smooth-Star® Flush-Glazed Doors with Elevated Bottom Rail



More natural light.

Ideal for multi-family new construction and remodeling, the popular 8'0" Smooth-Star flush-glazed full-lite door has been redesigned with an elevated bottom rail to meet ADA requirements.* Starting on page 153.

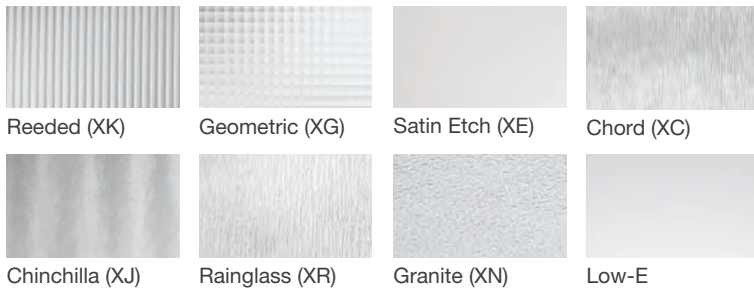

Residential



Commercial & Multi-Resident



EnLiten™ Flush-Glazed Riders
for Construction & Installation, and Homeowners



Elevated
U1: 10-1/4"
Book / Hybrid: 10-15/32"

8'0" Flush-Glazed Full-Lite Door

*For ADA compliance, door must be 3'0" wide.

Note: Smooth-Star products used in multi-family or commercial settings are backed by a 3-year limited warranty. See your Therma-Tru seller or visit www.thermatru.com for details on available product sizes and options, limited warranties and exclusions, Riders, ENERGY STAR qualified products, product approvals and installation instructions. Please verify that there is a Therma-Tru product approval for the configuration before buying.

Top: Smooth-Star, Clear Glass, Door – S8000, Finish – Onyx

NEW Retractable Screen Doors

for Therma-Tru® Door Systems



A breath of fresh air.

Discover a retractable screen solution with a discreet, hidden design – providing a seamless transition from indoors to outdoors. The Therma-Tru retractable screen door allows fresh air and natural light inside while keeping debris and insects out. Plus, it's been quality tested for compatibility with Therma-Tru entry door systems.

Available with most Therma-Tru® inswing door systems, starting on page 42.



Installation is quick and easy, taking approximately 30 minutes.*

Warranty Coverage (Excluding screen mesh.)

When purchased with a Therma-Tru door system.



Classic Craft



Fiber-Classic,
Smooth-Star,
Pulse Fiberglass



Profiles, Traditions,
Pulse Steel



When installed separately.

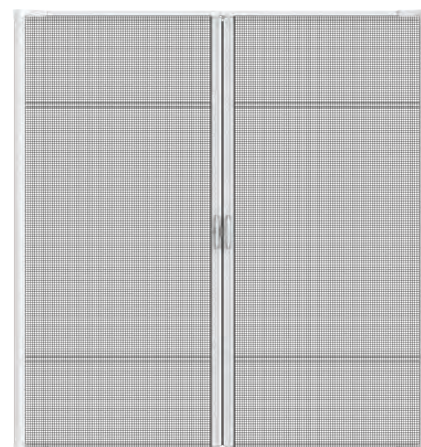

*Based on average DIY skills and standard door application, widths 32"-36".

Note: Recommended for inswing applications only. Therma-Tru retractable screens are designed to support natural ventilation and protection against airborne insects and other pests. Windy conditions may affect the performance of the screen. Retract the screen in windy circumstances, during inclement weather and when not needed to support immediate ventilation or prolonged periods of time when not used. Not intended to keep pets inside. See your Therma-Tru seller or visit www.thermatru.com for details on limited warranties and exclusions.

Top: Fiber-Classic Mahogany Collection, Clear Glass with SDLs, Door – FCM4816, Finish – Acorn, Retractable Screen – White

NEW Impressions™ Storm & Entry Door System

Therma-Tru® in Partnership with LARSON®



Purposeful design.

Explore first-to-market advanced technology in an integrated storm and entry door solution* from Therma-Tru, in partnership with LARSON. The Impressions integrated storm and entry door system is designed to outperform expectations.

Starting on page 44.

We're better together.

Therma-Tru and LARSON offer a combined 120+ years of innovation and market-leading solutions to deliver high-quality products you can trust from the #1 entry door brand** and #1 storm door company.***



*Patent pending.

**Brand Use Studies, 2021 *Builder* and 2019 *Remodeling* magazines.

***Based on market data 2020 / 2021.

Note: See your Therma-Tru seller or visit www.thermatru.com for details on available product sizes and options, limited warranties and exclusions, and installation instructions.

Top: Impressions Storm & Entry Door System – IM100, Finish – Black; Smooth-Star, Clear Glass with GBGs, Door – S2103, Finish – Onyx
 Right Page: Classic Craft Mahogany Grain, Zaha Glass, Door – CCM82302, Sidelites – CCR81851SL, Finish – Shale

A smart investment.

Lifetime Limited Warranties

We stand behind more parts and for longer than other door companies because we make or specify everything that goes into our door system. A Therma-Tru fiberglass door system is backed by the industry's most comprehensive lifetime limited warranties.



Energy Efficiency

In any region or climate, energy efficiency is key. More than 80% of Therma-Tru door and glass options are ENERGY STAR® qualified and National Fenestration Rating Council (NFRC) certified, helping save money on energy costs.



Quality Testing

Our doors, glass and components are held to high standards. We conduct thorough testing to help ensure that our products will live up to a homeowner's toughest quality and performance expectations.



The Beauty of Choice

The architectural beauty of a Therma-Tru door is easy to see. With the look of real wood, rich panel details and intricate, handcrafted decorative glass designs, there are thousands of possibilities to suit the style of a home and express a homeowner's personal style.

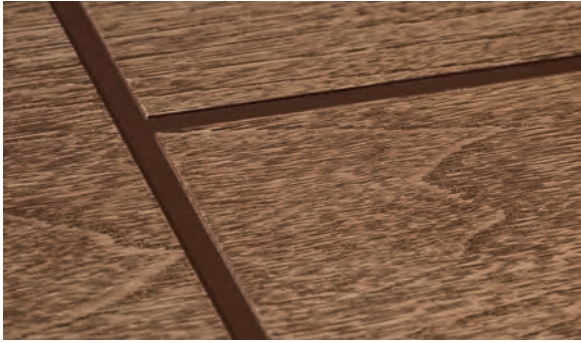

Door Selections

Find choices in design, texture and material with many configurations available to find the ideal door system. More on pages 22–23.



Finish Options

Complete the desired look with stain or paint. Explore a variety of colors from PrismaGuard® premium finish and Same-Day® stain on pages 274–278.



Decorative & Specialty Glass

Complement any Therma-Tru door with a variety of glass shapes and designs. More on pages 30–35.



Door System Components

Have confidence in a door system made with genuine Therma-Tru components to meet the needs of many applications. More on pages 24–29.

Bottom: Smooth-Star, Clear Glass with SDLs, Door – S4814, Sidelites – S2000SL, Finish – Onyx
 Right Page: Classic Craft Mahogany Grain, Granite Glass with SDLs, Doors – CCM8306CARXN, CCM8306CALXN, Finish – Autumn Harvest





Selecting a Door System

Therma-Tru pays close attention to regional and consumer trends to deliver choices designed to inspire. Keep these considerations in mind when choosing from our portfolio of door system products:

- What is the size of the doorway?
- What is the style of the home?
- Does the homeowner want to stain or paint the door?
- How much light or privacy is desired?

Also consider:

- Building codes specific to applications, such as house-to-garage, as well as regional weather conditions.



Make a Smart Investment



After

The importance of curb appeal.

A stylish new front entryway can help convey your personal style and highlight your home's overall architectural style and curb appeal.

“The door gives a focal point to the front of the house.”
– Homeowner, Survey Respondent



Before

*Not a guarantee of investment returns, increase in value or selling price. See 2021 Therma-Tru National Home Valuation Study surveying real estate agents about perceived remodeled home value estimates based on exterior appearance. Not based on actual home sales data. Results may vary based on region, door style and home style. Study was commissioned by Therma-Tru and conducted by the Farnsworth Group, an independent research provider.

Fresh look. Increased value.

In a recent survey, real estate agents were shown images of various homes, including some that had been modified with a new Therma-Tru door, and asked to estimate the value of the home. While results varied, the survey suggests choosing a Therma-Tru door that complements the home's architecture could **add up to 7% to the perceived value** of a remodeled home.*

That's a potential increase of up to \$21,000 on a \$300,000 home for a project that can be done in a single day.

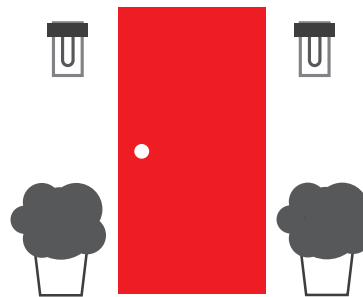

Renovating?

Get the most for your money. A new entry door can pay for itself – and then some. A recent survey suggests homeowners who choose a stylish new Therma-Tru entry can significantly improve the curb appeal of their home, and with a door that complements their home's architecture, can increase the overall perceived value of their home.*

Selling soon?

In a recent survey, 44% of homeowners said they were more likely to purchase a home with an enhanced entry, and one in three homeowners said they were willing to pay a premium for one.*

“In my experience on both the seller and buyer side, the entry door is always key.”

– Real Estate Agent, Survey Respondent



According to most real estate agents and trade professionals in a recent survey, curb appeal is one of the top three factors for home buyers.*

Door Selections

Choose from our many door selections to complement the architectural style of the home from the front entry to the back patio. The possibilities are endless from fiberglass and steel materials to wood-grained and smooth textures to stainable and paintable finishes.

The Classic Craft® Series Pages 46-127

Our premier engineered-to-last entryways showcase remarkably authentic wood grains and textures. Explore three curated collections inspired by the latest trends to bring your home design vision to life.



Artíssa Collection Casual | Relaxed | Simple



Founders Collection Traditional | Time-Honored | Decorative

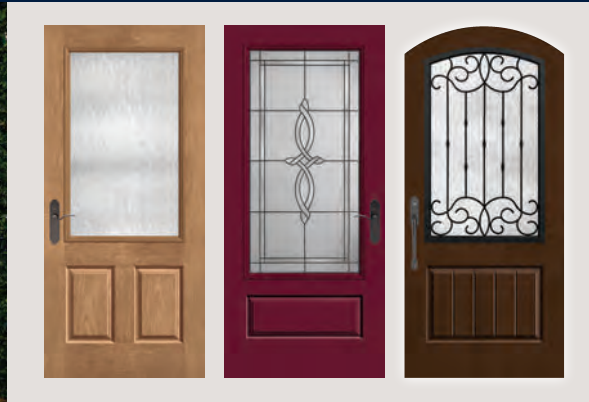

Visionary Collection Modern | Confident | Minimal

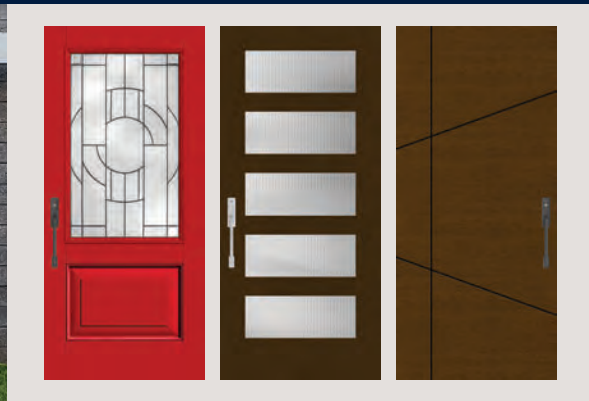

Note: Finish colors may vary from an actual application due to fluctuations in finishing or printing. See your Therma-Tru seller or visit www.thermatru.com for details on limited warranties and exclusions.

Fiber-Classic® Collections Pages 128–227

The industry's first fiberglass door delivers the look and feel of real Mahogany and Oak with excellent performance and value.



Mahogany Collection™

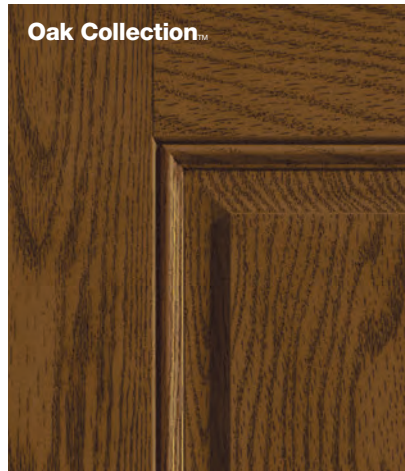

Oak Collection™



Smooth-Star® Pages 128–227

A smooth, ready-to-paint fiberglass door that offers excellent performance and value.

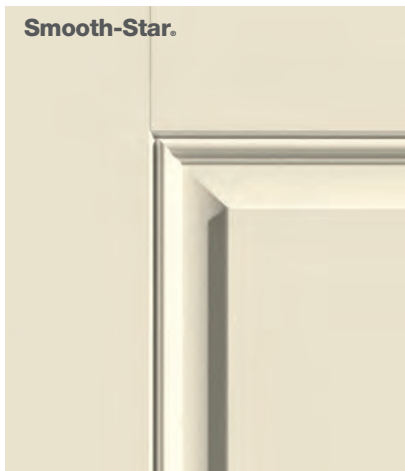

Smooth-Star.



Steel Pages 228–253

Bring style and affordability together to create very attractive results with our steel doors.



Profiles™



Door & Glass



Traditions



Door



Glass

Pulse® Pages 260–273

A contemporary series of door styles and glass designs that can be combined to make a bold statement.



Fiberglass



Steel



Ari



Línea



Echo

Engineered to Work Together

Our complete door systems feature doors, glass and components engineered to work together to resist leaks and drafts, and help maintain energy efficiency and weather resistance.



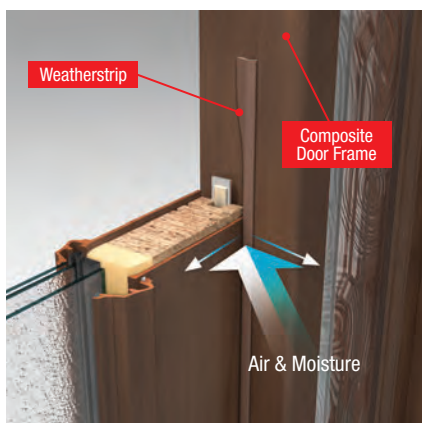

1 Weatherstrip is engineered in a variety of profiles to provide the best possible fit with our door systems, helping to deliver a precise seal between the **door** and **frame**. In addition, a rot-free Therma-Tru **composite door frame*** delivers extra protection from the damaging effects of moisture.

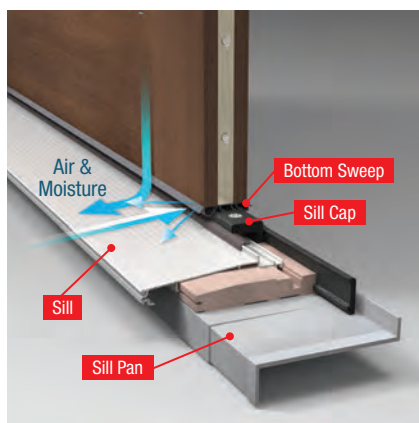

2 Sill and bottom sweep form a tight seal against wind-driven moisture infiltration at the bottom of the door system and help channel moisture away from the home. **Sill pan** (recommended) adds an extra layer of protection to help keep moisture away from the subfloor.

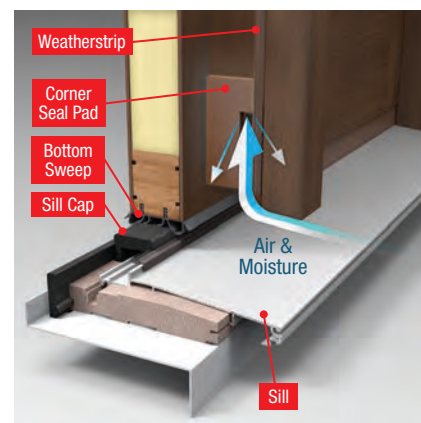

3 Corner seal pads (inswing only) complete the seal between the **sill cap**, **bottom sweep** and **weatherstrip** to help block potential pathways where wind-driven moisture can infiltrate the bottom corner of the door system.

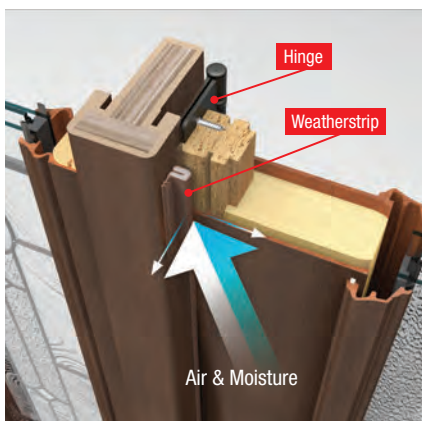

4 Hinges position the **door** to properly compress the **weatherstrip** to help form a tight, even seal against air and moisture infiltration when the door closes.

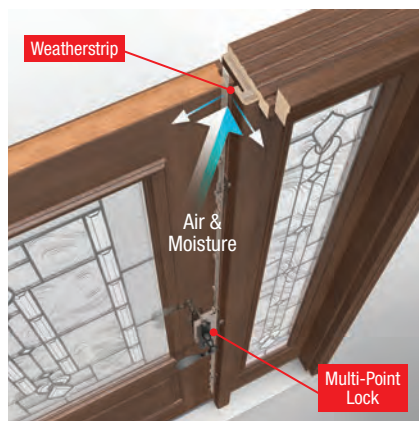

5 Multi-point locking system (recommended) engages the door and frame at three points from top to bottom for enhanced security while helping to preserve the **weatherstrip's** seal even under wind pressure.

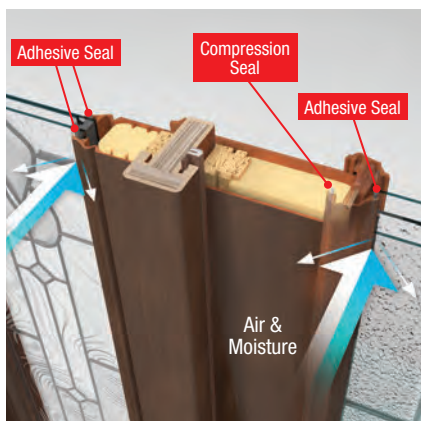

6 Lip-lite frame (shown right) features a **compression seal** against weather on the outside of the **door** and an **adhesive seal** against weather on the outside of the **glass**. **Flush-glazed glass** (shown left) is built directly into the door without a Lip-lite frame, featuring a **high-performance adhesive weather seal** inside and out.

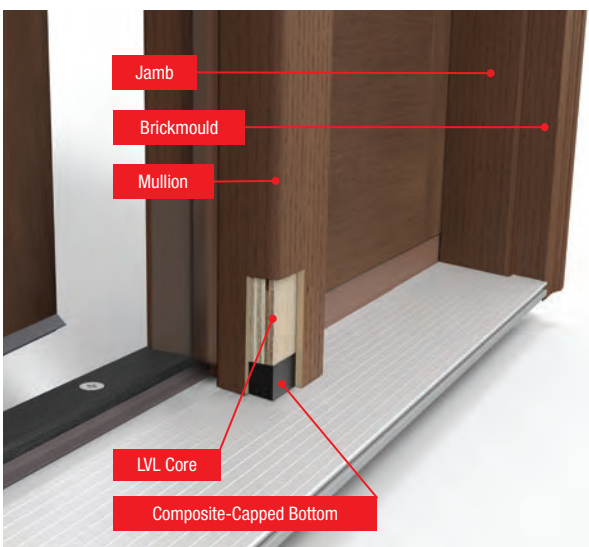

Composite Door Frame* featuring Tru-Guard™ Composite Technology

Therma-Tru® composite door frame featuring Tru-Guard™ composite technology provides a rot-free solution engineered to work together with rot-resistant Therma-Tru doors and components.

TRU  **GUARD**
COMPOSITE TECHNOLOGY

Tru-Defense® Warranty Rider

A Therma-Tru. door system with Tru-Defense system components is a high-performing door system backed by a lifetime limited warranty and a comprehensive Tru-Defense Warranty Rider.



Tru-Defense: The Ultimate Protection

More than beautiful doors and glass; a complete door system includes the components used to assemble it. We manufacture or specify every aspect of a complete door system. The Therma-Tru. genuine components in a Tru-Defense door system are our premium options for long-lasting durability.

Double Your Peace of Mind

When it comes to door systems, we believe that proper installation is just as important as having the best components. A Tru-Defense door system installed by a Therma-Tru Certified Door System Installer doubles your reimbursement eligibility should an issue arise.* Look for the  icon.

CERTIFIED
DOOR SYSTEM
INSTALLER

THERMA-TRU®
DOORS

*The Rider does not warrant workmanship of anyone who assembles or installs a Tru-Defense door system, including Therma-Tru Certified Door System Installers, nor any damages caused by improper handling, assembly or installation.

**Latch and deadbolt must meet Therma-Tru specifications.

Note: See your Therma-Tru seller or visit www.thermatru.com for details on limited warranties and exclusions.

Top: Classic Craft Canvas, Provincial Glass, Door – CCV10028, Sidelites – CCV108SL, Transom – CC420T, Finish – Chestnut

Required Components for Tru-Defense Door System

with Therma-Tru Fiberglass Door Slab & Components



Door Frame ❖

Provides a solid structure for the door slab and components.
Recommended: Therma-Tru Composite Door Frame



Corner Seal Pads ❖

(Inswing Only)
Fit securely behind the weatherstrip to help block wind-driven moisture infiltration at the bottom corner of the door system.



Composite Adjustable Sill ❖

Provides a solid stepping surface and forms a tight seal at the bottom of the door system to help channel moisture away from the home.



Weatherstrip ❖

Features a resilient design to help deliver a precise seal between the door and frame.

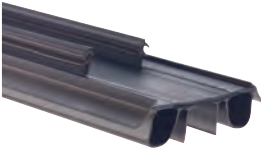

Bottom Sweep ❖ (Inswing Only)

A dual-bulb, dual-fin design helps maintain tight contact with adjustable sill caps and creates added barriers against moisture.



Astragal ❖ (Double Doors)

Cover the margin between double doors to help complete the seal against air and moisture infiltration, with aluminum construction for stability, holding power and durability.



Hinges ❖

Ensure smooth operation and position the door so it creates a tight seal with the weatherstrip when closed.



Rain Guard ❖ (Outswing Only)

Creates a barrier at the top of the door to protect against moisture infiltration.

Recommended Components



Multi-Point Locking System ❖

(MPLS)
Engages the door and frame at three points from top to bottom for enhanced security and sealing.

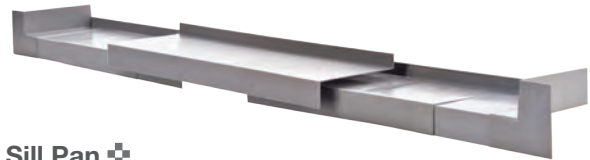

Sill Pan ❖

Adds an extra layer of protection to help keep moisture away from the subfloor; protects flooring by catching and draining water in the event of infiltration.

Levels of Reimbursement

System Components	Reimbursement Eligibility	Reimbursement Eligibility with a Certified Installer
Latch & Deadbolt (No Sill Pan)**	\$250	\$500
Latch & Deadbolt with Sill Pan**	\$500	\$1,000
MPLS (No Sill Pan)	\$1,000	\$2,000
MPLS with Sill Pan	\$1,250	\$2,500

Baseline components required to qualify for the Tru-Defense Warranty Rider.

Fiberglass Door Systems Built for Safety & Security

Protect the home and everything in it, from family and pets to valuables and keepsakes. Therma-Tru products are designed for durability and enhanced security with pieces and parts engineered as a complete system.

Did you know?



On average, a home is burglarized in the U.S. every 45 seconds.¹

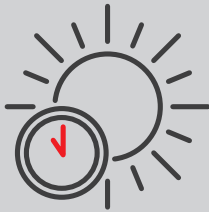

More than half of home burglaries occur during the daytime.²

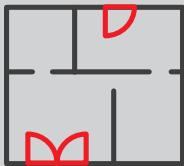

How do burglars enter the home?

34% Front Door³

22% Back Door³



Home burglary rates are highest in the summer.⁴

Therma-Tru Composite Door Frame

More reliable and up to 50% stronger on average than standard wood door frames when withstanding a simulated forced entry attempt by kicking in the door.*

- Features full-length jambs with no finger joints for more reliable performance, and a continuous composite material that will not deteriorate over time, like wood.
- Entries with a wooden door frame are more susceptible to being kicked in as compared to a Therma-Tru composite door frame, giving burglars access to your home within seconds.
- Wood jambs typically have finger joints. These areas where two pieces of wood come together are structurally weaker when compared to a single continuous material that runs the entire length of the jamb.



Scan to see our products put to the test.



*Comparison of pendulum impact test results for Therma-Tru composite door frame and standard finger-jointed Pine wood door frame, both with similar pre-hung doors.

**Comparison of pendulum impact test results for Therma-Tru doors in steel versus fiberglass. Visit www.thermatru.com for details.

¹Source: FBI Uniform Crime Reporting Program, "2019 Crime in the United States."

²Source: FBI Uniform Crime Reporting Program, "2019 Crime in the United States," Table 7.

³Source: www.asecurelife.com

⁴Source: U.S. Department of Justice, Bureau of Justice Statistics, "Seasonal Patterns in Criminal Victimization Trends," June 2014.

Therma-Tru Fiberglass Door Slab

Up to 30% more resistant to kick-ins than standard steel doors.**

Features durable construction that can withstand impact by absorbing and deflecting the force.**

- Built with enhanced lock blocks to help ensure proper handleset reinforcement, combined with lock and hinge stiles that increase rigidity and stability.
- Will not dent or rust, nor will it warp, split, crack or rot.

Therma-Tru Glass

- Options feature double- or triple-pane construction and include two panes of tempered glass for enhanced safety and performance.



Pendulum Impact Test

Material Myths: Think steel is stronger? Think again.

- While many people assume steel doors are the most secure against forced entry, Therma-Tru fiberglass doors are up to 30% more resistant to kick-ins than standard steel doors.**
- Standard steel doors can dent and bow, which leads more quickly to product failure. Therma-Tru fiberglass doors feature durable construction that can withstand impact by absorbing and deflecting the force.**
- Wood doors and steel doors may weaken over time with exposure to the elements.



Decorative & Specialty Glass

A Therma-Tru door system with decorative glass can create an entrance that makes a statement — one that says the homeowner has high standards for style, quality and craftsmanship.

- Our wide array of glass designs, from simple to intricate, reflect the home design trends and homeowner desires of today and tomorrow.
- Our glass designs are researched in the market to ensure they are highly rated in consumer preference.
- Numerous glass colors, textures, shapes and coming options are available to complement any door.
- All Low-E and clear glass panels are tempered or laminated to provide added safety.

Note: See your Therma-Tru seller or visit www.thermatru.com for details on ENERGY STAR qualified products.
 Bottom: Classic Craft Mahogany Grain, Borrassa Glass, Door – CCR822215, Sidelites – CCR8000XHSL



Contributes to an energy-efficient home.



Triple-Pane Construction

All triple-pane decorative, as well as privacy and textured, glass panels are enclosed between tempered glass, offering superior quality and thermal performance.



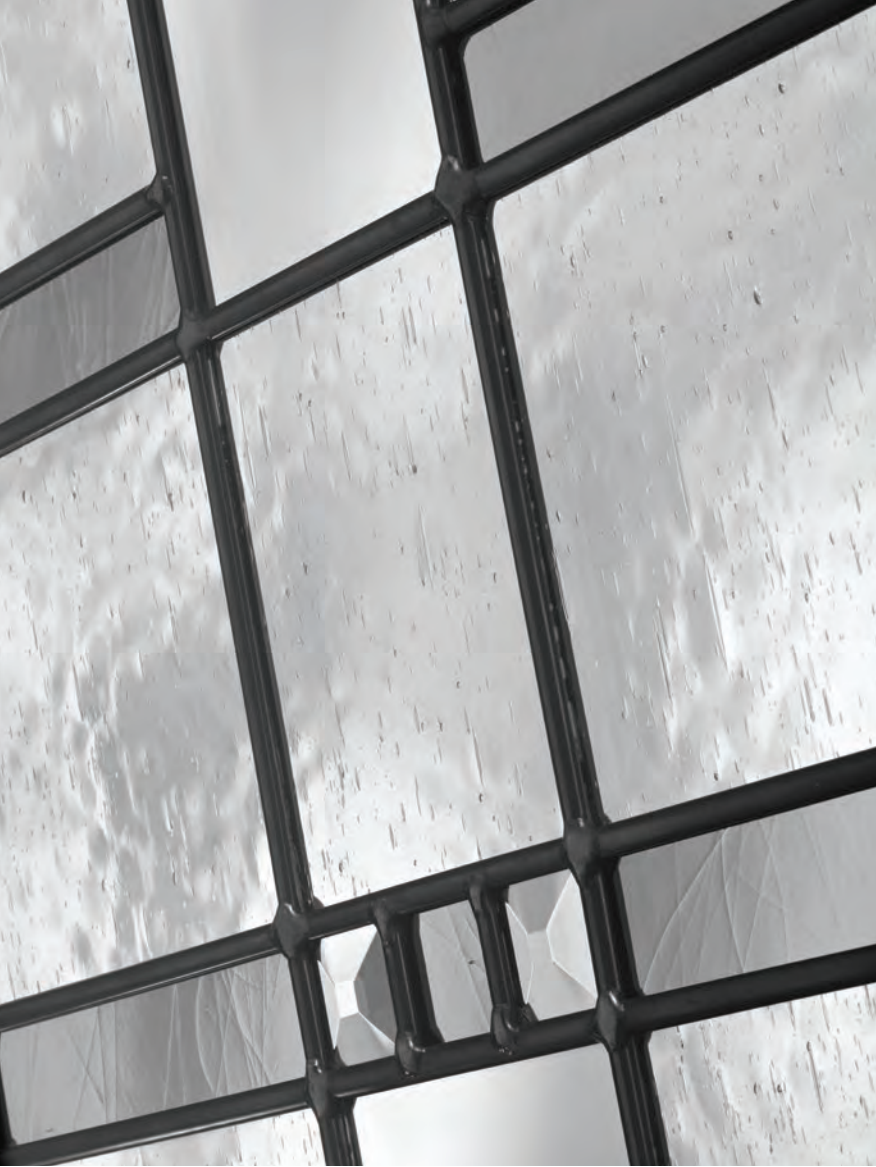

Our decorative glass is handcrafted and built with all-glass bevels for premium quality.

Find entry doors arranged by glass size, from large to small, to help you find products that meet homeowners' needs for natural light.



EnLiten™ Flush-Glazed Designs

For Classic Craft®, Fiber-Classic® & Smooth-Star® Doors & Sidelites

Simplified beauty. Resilient designs. With clean lines and seamless construction, EnLiten flush-glazed designs are perfect for today's homes. Built for long-term performance, these doors and sidelites feature the sleek looks homeowners want and the stylish around-the-home solutions they need. Look for the (🔥💧) icons.



Front Entry

See the difference.

EnLiten flush-glazed designs provide a simple profile with no added embellishments around the glass.



Flush-Glazed Glass with Detailed Sticking 🔥



Flush-Glazed Glass with Square Sticking 💧

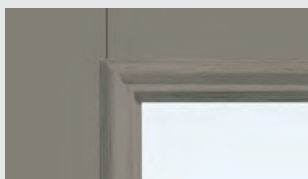

Lip-Lite Frame

Maximum views.

Create an airy, open feeling in the home with larger daylight openings. EnLiten™ flush-glazed designs offer up to a 16% increase in visible glass area than conventional lite frames.



Flush-Glazed Glass



Lip-Lite Frame

*Comparison of U-factor values of a flush-glazed full-lite door and a Lip-lite full-lite door, both with Low-E glass.

**Must be installed as part of a Therma-Tru door system in compliance with a Therma-Tru product approval. Impact-rated products not available.

Top: Classic Craft Fir Grain, Satin Etch Glass with SDLs, Doors – CCA82320XE, Finish – Raven
 Right Page Top Left: Fiber-Classic Oak Collection, Low-E Glass with GBGs, Door – 2150, Finish – Raven
 Right Page Bottom Left: Smooth-Star, Internal Blinds, Doors – S2600
 Right Page Right: Fiber-Classic Mahogany Collection, Chord Glass with SDLs, Door – FCM4814XC, Sidelites – FCM2050XCSSL; Low-E Glass, Transom – 19220T, Finish – Acorn



Utility Door



Front Entry



Patio Doors

Durable by design.

Double- or triple-pane glass is built directly into the door with a high-performance dual adhesive weather seal. This delivers a clean seamless look with no lite frame or screw plugs, and reduces the potential for air and water infiltration, among other benefits.



Superior Sound Dampening

Doors with flush-glazed glass do a better job of dampening outside noise compared to a Lip-lite alternative.



11% More Energy Efficient

The Low-E glass used in flush-glazed doors delivers a clear view and is 11% more energy efficient than 1/2" Low-E glass in a Lip-lite frame.*



Withstands Winds Up to 167 mph

Door systems with flush-glazed glass are designed and tested to withstand wind forces up to 167 mph (DP-50).** (ASTM-E330)

Warranty riders for peace of mind.

EnLiten™ Flush-Glazed Rider for Construction & Installation

Provides protection in case of accidental glass breakage during residential and multi-family construction or installation. Therma-Tru will replace the flush-glazed fiberglass door or sidelite.

EnLiten™ Flush-Glazed Rider for Homeowners

Provides protection in case of glass-related failures due to manufacturer defect. Therma-Tru will furnish \$300 toward installation and replace the flush-glazed fiberglass door or sidelite.

Convenient choices for more light.

Privacy & Textured Glass

Therma-Tru® doors and sidelites can be fitted with our beautiful privacy and textured glass. This versatile assortment aligns with personal style and homeowner desires for privacy while allowing natural light to brighten the interior.

- Category includes diverse textures for individual design expression.
- Varying opacity levels range from 7-10.
- All privacy and textured glass options are triple-pane, providing thermal efficiency.
- Triple-pane construction also allows for an easy-to-clean surface.
- Available with two Lip-lite frame options, as well as seamless flush-glazed options, in select doors.

Available in Classic Craft®, Fiber-Classic®, Smooth-Star®, Profiles™, Traditions and Pulse doors and sidelites.



Low-E Glass

Factory-coated Low-E glass delivers exceptional energy efficiency. Available in Classic Craft, Fiber-Classic, Smooth-Star, Profiles, Traditions and Pulse. Look for the (☀️) icon.



In cold weather, Low-E glass can help reduce the loss of heat by reflecting the heat back inside the home.

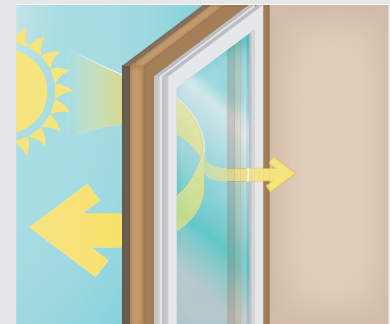

In warm weather, Low-E glass reflects the sun's rays off of the glass, helping to keep the interior of the home cool.

Top: Classic Craft Fir Grain, Geometric Glass with SDLs, Doors – CCA2300XG, Finish – Raven
 Bottom: Smooth-Star, Clear Glass with Fixed Grilles, Door – S262
 Right Page Top: Smooth-Star, Internal Blinds, Door – S82600



Internal Blinds

Enjoy the privacy and convenience of a cordless blind enclosed between glass. Control the desired level of light and privacy with the simplicity of a single handle.

- Protected between two panes of tempered glass for enhanced safety and performance.
- With no dangling cords, this is a kid- and pet-friendly choice.
- Blinds remain dust free, and glass is easier to clean than traditional blinds.
- Choose Low-E glass for improved energy efficiency or standard clear glass.
- EnLiten™ flush-glazed designs and Impact-rated options available.

Available in Fiber-Classic®, Smooth-Star®, Profiles™ and Traditions doors and sidelites.

Divided Lites

Enhance the beauty of any home with a variety of divided lite options for entry and patio doors. Tailor the look with different texture, profile, width and color choices. For Classic Craft, see page 68. For Fiber-Classic & Smooth-Star, see pages 140–141.

- Coordinate with the home's window patterns for a cohesive look and increased curb appeal.
- Choose from Colonial, Craftsman or Prairie styles to suit the home's architectural details.
- Available divided lite options include simulated divided lites (SDLs), grilles between glass (GBGs) and fixed grilles.
- Available glass options include elegant privacy and textured, as well as energy-efficient Low-E and clear glass.



Tough when you need it. Beautiful always.

High-Power Testing

Our Impact-rated doors pass a large missile impact test. We blast a 9 lb. 2" x 4" stud into the doors at 34 mph to prove they're the better choice for strength and stability.

Impact-Rated Products

Therma-Tru offers Impact-rated doors and glass that can be used to meet high-wind and coastal region codes and regulations, offering excellent performance in extreme weather conditions while providing added protection.

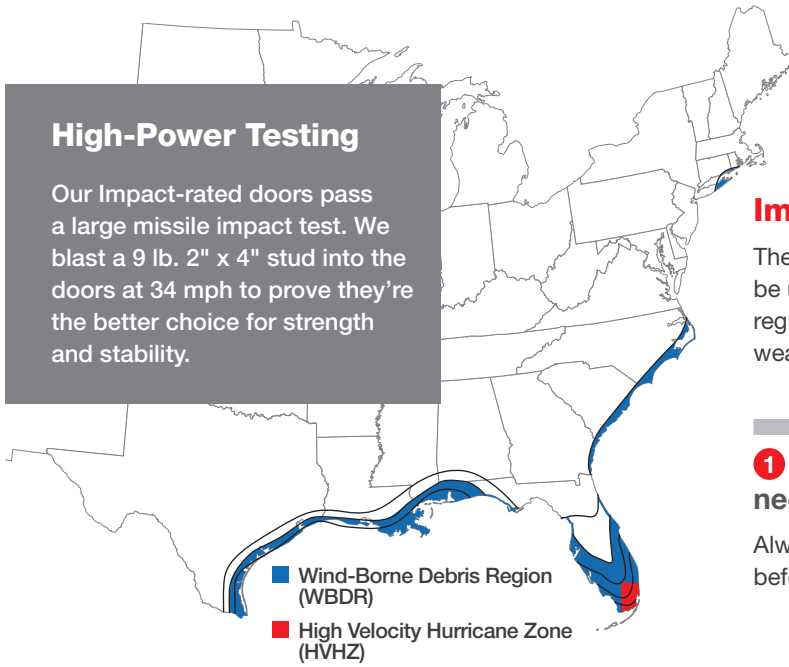

1 Use the map as a guide to find out if you need product for WBDR or HVHZ.

Always confirm building code requirements in your area before buying.*

2 Use the icons to find available Therma-Tru® product options in this catalog.

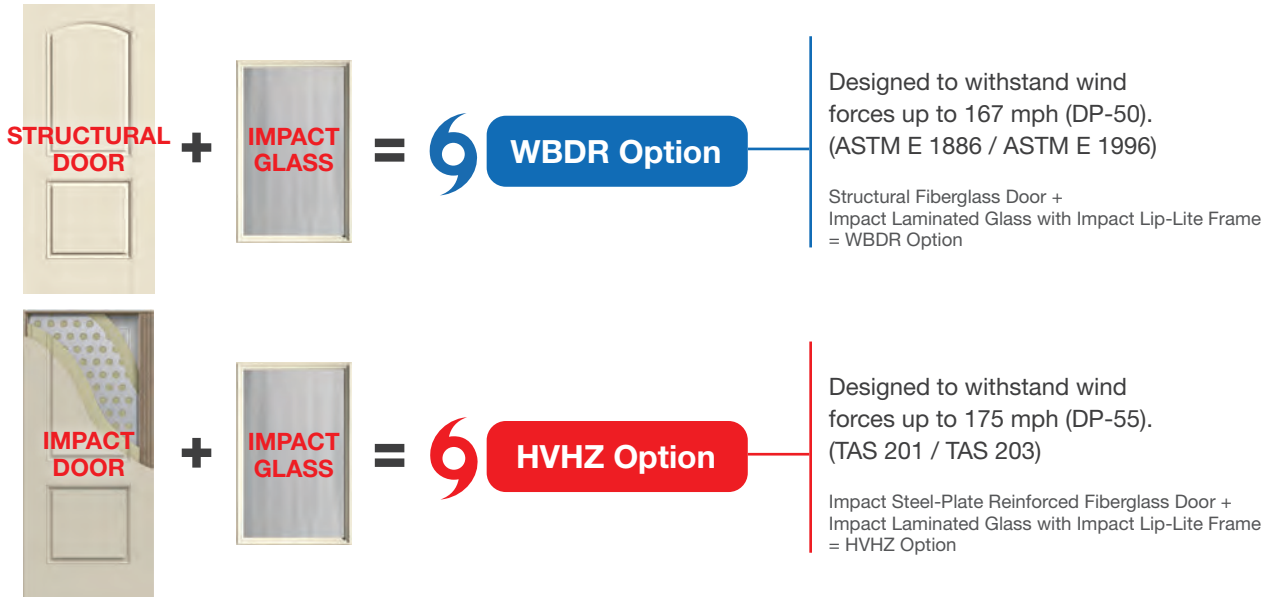

WBDR / HVHZ Options: Look for this icon to find door and sidelite styles that can be configured for WBDR or HVHZ.

3 Verify that there is a Therma-Tru product approval specific to your area for the door system configuration before buying.*

4 Make sure the product is installed in compliance with the product approval to meet building codes.

The performance of the door system depends on how it is installed. Proper installation is required to comply with building codes.

*Product approvals show that the door system meets applicable codes when selected, assembled and installed as instructed. Note: See your Therma-Tru seller or visit www.thermatru.com for product approvals and installation instructions. Always confirm building code requirements in your area before buying. Follow weather and news reports to assess severe weather situations and obey local authorities' shelter and evacuation orders. No product guarantees safety for persons or property, nor makes any premises hurricane- or impact-proof.

Constructed to help protect the interior of the home from flying debris and high winds associated with tropical storms and hurricanes, these products are tested to meet codes and regulations in coastal regions, including parts of Florida, Texas and the Carolinas.*

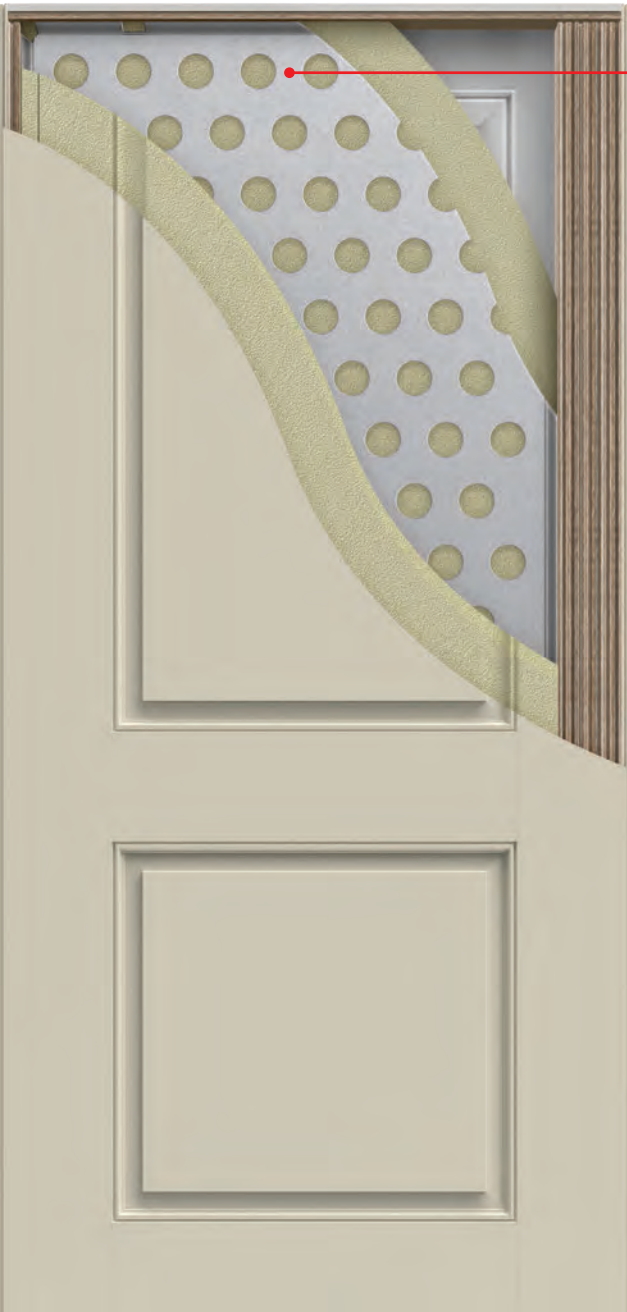

Impact Doors

Feature a built-in 24-gauge steel plate lining.

Impact Glass

Features special laminated glass construction.



Impact-Rated Internal Blinds

Features laminated glass construction and a durable, paintable aluminum lite frame with a flat profile aesthetic cover for a simple look.



Impact Lip-Lite Frame

Features durable, paintable aluminum construction.

An attractive scrolled profile gives a thin, sleek appearance and a screw channel cover helps hide unsightly screws.

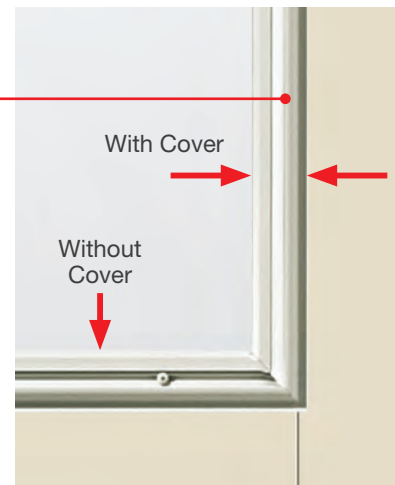

Other Considerations

Fire Doors
See pages 254–259.

Noise Reduction Doors
See page 218.

Elevated 10" Bottom Rail
Look for the (E) symbol.

Connect with nature, inside and out.



Top: Classic Craft Fir Grain, Low-E Glass, Doors – CCA82400, Finish – New Earth
Right Page, Top: Smooth-Star, Clear Glass, Doors – S2000, Finish – Alpine, Retractable Screen – White
Right Page, Bottom: Impressions Storm & Entry Door System – IM100, Finish – Black; Classic Craft Fir Grain, Low-E Glass with SDLs, Door – CCA2380, Finish – Raven

Outdoor living made easy.

Families can connect with the outdoors through fresh air and sunlight, all from the comfort of home. Explore a variety of entry solutions designed for seamless indoor-outdoor living, including patio and storm doors, retractable screens and vented sidelites.



Hinged Patio Door Systems

Patio, Storm & Vent



Simply beautiful,
any way you see it.

Extend the beauty and quality of a Therma-Tru® entrance to the back of the home with hinged patio doors. Find style and convenience that's unsurpassed from any view with options to control the level of privacy and light, complement window patterns, and let fresh air into the home.

Note: See page 299 for important product details that may help with your purchase decision.

Top: Fiber-Classic Oak Collection, Clear Glass, Doors – 8000, Finish – Driftwood
Bottom: Smooth-Star, Clear Glass, Doors – S2000

A Thermo-Tru® patio door with genuine Thermo-Tru components is a complete door system with doors, glass and components engineered to work together for durability and reliability through the years.

Interior view of door.



- 1 Multi-Point Locking System (Recommended)
- 2 Bottom Sweep
- 3 Sill
- 4 Hinges
- 5 Corner Seal Pads (Inswing Only)
- 6 Sill Pan (Recommended)
- 7 Frame Components
- 8 Multi-Point Locking System (Included)
- 9 Removable Screens

Vented Sidelites

Enjoy the view – and a fresh breeze, too.

- Constructed to provide ventilation without sliding screens blocking the view, vented sidelites work as small swinging doors with convenient removable screens – available in bronze and white.
- Engineered for durability and safety with wide patio mullions for strength, and multi-point locking gears and recessed strike plates for security.

Look for the (●) symbol.

Available Configurations



Single Door with Vented Sidelites (Inswing Only)



Double Doors with Vented Sidelites (Inswing Only)

Patio Transoms

Transoms can be stained or painted to match a Fiber-Classic® or Smooth-Star® door system. Available for 5'0", 5'4", 5'8" and 6'0" patio openings.

Note: Patio transoms are designed for a unit with a mullion.

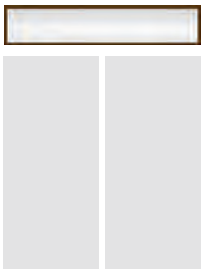

19250T

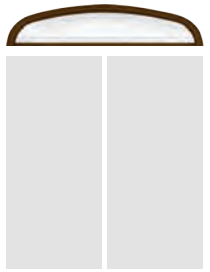

19050T

Classic Craft, starting on page 124.
 Fiber-Classic, Smooth-Star, Profiles & Traditions, starting on page 222.

NEW Retractable Screen Doors

Welcome fresh air and natural light into the home while keeping debris and insects out. Therma-Tru retractable screen doors feature a discreet, hidden design that helps provide a seamless transition from indoors to out. Plus, it's been quality tested for compatibility with Therma-Tru® entry door systems.

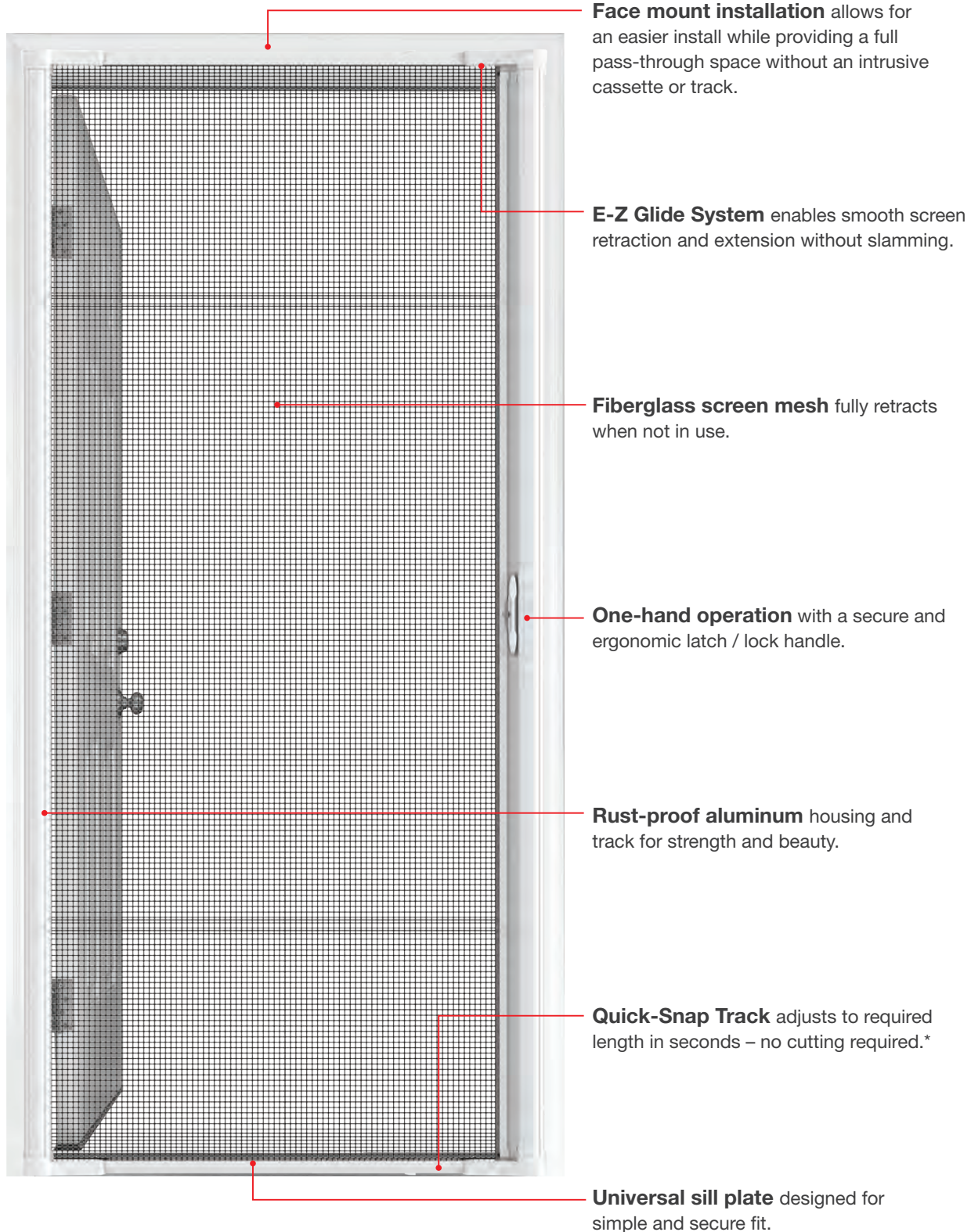

*Adjusts quickly for 32"-36" doors. If less than 32" a hacksaw is required for one cut to each track.

**Retractable screen frame colors are complementary to PrismaGuard, but not an exact match.

Note: Recommended for inswing applications only. Therma-Tru retractable screens are designed to support natural ventilation and protection against airborne insects and other pests. Windy conditions may affect the performance of the screen. Retract the screen in windy circumstances, during inclement weather and when not needed to support immediate ventilation or prolonged periods of time when not used. Not intended to keep pets inside. See your Therma-Tru seller or visit www.thermatru.com for details on limited warranties and exclusions.



Available Sizes

(Available for most inswing units.)

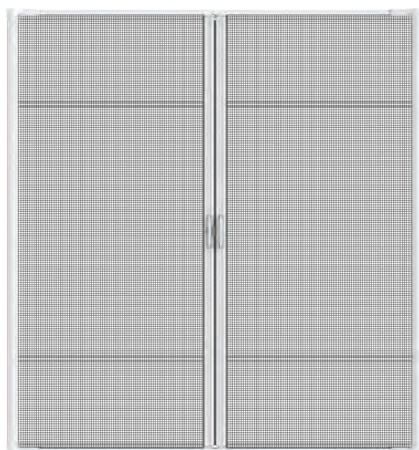
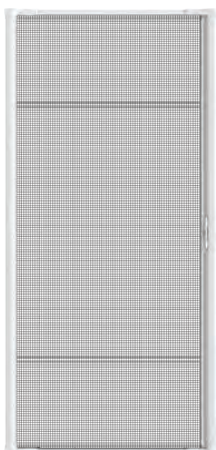

Single Door System

Widths: 32"–36"
Heights: 6'6", 6'8", 8'0"

French Door System

Widths: 68"–73"
Heights: 6'6", 6'8", 8'0"

Available Color Options

Coordinates with exterior trim.**



White

Brown

Black

Available Configurations

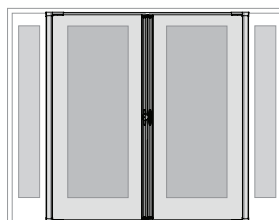
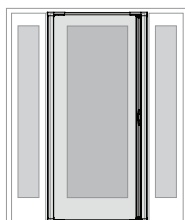
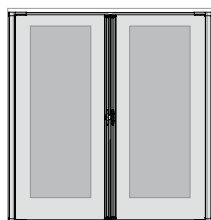

See your Therma-Tru seller for details on product availability and ordering.

Warranty Coverage

All parts are covered by the Therma-Tru full-system limited warranty, excluding the screen mesh, when purchased and installed with a Therma-Tru door system.

When purchased and installed separately all parts are covered by a full-system lifetime limited warranty, excluding the screen mesh.



Classic Craft



Fiber-Classic,
Smooth-Star,
Pulse Fiberglass



Profiles, Traditions,
Pulse Steel



NEW Impressions™ Integrated Storm & Entry Door System

The first of its kind, the Impressions storm and entry door system* integrates the storm door flush into the brickmould portion of the door frame, creating a cohesive unit that provides a seamless look. With an integrated system engineered to work together, this system takes the guesswork out of ordering the right size storm door for your project and simplifies storm door installation.



1 Choose a **Therma-Tru® single entry door**** to create an entry that complements your home's architectural style.



2 The Impressions system comes standard with **composite brickmould** and an aluminum storm door panel. For added protection from rotting, choose a **composite frame featuring Tru-Guard™ composite technology**.

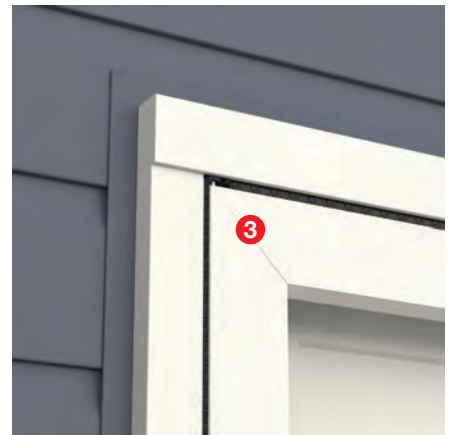

3 The storm door features a modern profile with mitered corners for a sleek, on-trend look that emphasizes the beauty of the entry door. The storm door panel fits into Therma-Tru's **flat-profile composite brickmould**.

*Patent pending.

**Compatible with with most 6'8" single entry Therma-Tru doors.

Note: See your Therma-Tru seller or visit www.thermatru.com for details on limited warranties and exclusions.

The storm door is easy to install at the jobsite.

The concealed hinges featuring retractable pins **4** and the revolutionary hidden closer with Click&Hold™ technology **5** enable a quick and intuitive installation experience. The storm door panel is handed in the field, simplifying what you need to order. After the installation of the entry door, hand your storm door by installing the closer, sweep and hardware. Then, follow these three simple steps to complete the job.

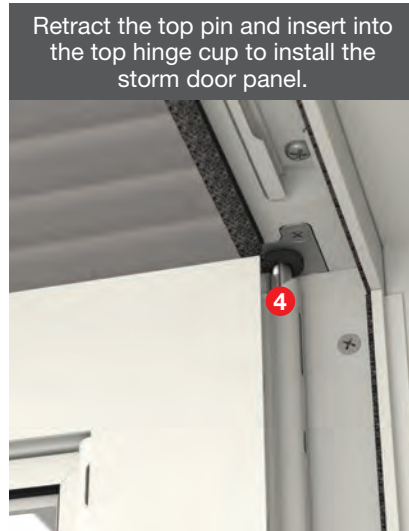
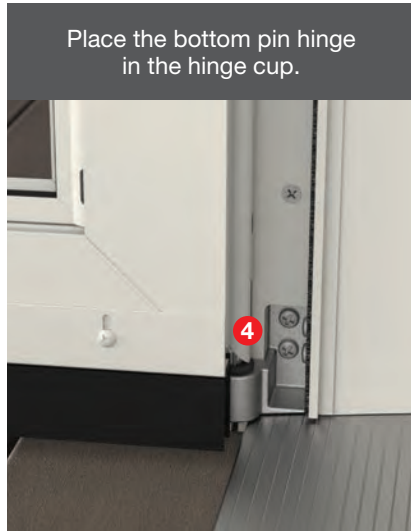

6 Aluminum Storm Door Options

Available for Single Entry Sizes

Choose Low-E or clear glass.
Interchangeable screen panel included.



Low-E / Clear

IM100

3'0" x 6'8"
2'8" x 6'8"

Color Options

Features a maintenance-free finish.

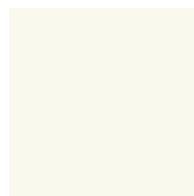

White
Color matched to PrismaGuard Alpine.



Gray
Color matched to PrismaGuard Granite.



Brown
Complements most PrismaGuard stains.



Black
Color matched to PrismaGuard Onyx.

7 QuickFit™ Handlesets

Straight



Brushed Nickel

Aged Bronze

Matte Black

Curved



Brushed Nickel

Aged Bronze

Antique Brass

Brass

CLASSIC CRAFT®



An unrivaled entry experience.

Transform the entry into a one-of-a-kind experience. One that blends artistry, craftsmanship and modern engineering. Captivate the senses with remarkably authentic wood grains, exquisite handcrafted glass and sumptuous design details found only in Classic Craft. Because homes with uncompromising style demand uncompromising entryways.

Top: Classic Craft Mahogany Grain, Low-E Glass with SDLs, Doors – CCM82804, Finish – Outback
Right Page Top: Classic Craft Fir Grain, Low-E Glass with SDLs, Door – CCA230, Sidelites – CCA210SL, Finish – Raven
Right Page Middle: Classic Craft Mahogany Grain, Low-E Glass with SDLs, Doors – CCM8303L, CCM8303R, Finish – New Earth
Right Page Bottom: Classic Craft Walnut Grain Door – CCW8906R, Low-E Direct Set Sidelite – DRS82131SL, Finish – Lynx

Curated collections inspired by style.

Classic Craft celebrates the best of design for homes with uncompromising style. Three expertly curated collections draw inspiration from the latest trends and bring your home design vision to life with unrivaled beauty, luxe craftsmanship and an attention to detail you won't find anywhere else.

Artissa Collection

Casual | Relaxed | Simple



Founders Collection

Traditional | Time-Honored | Decorative

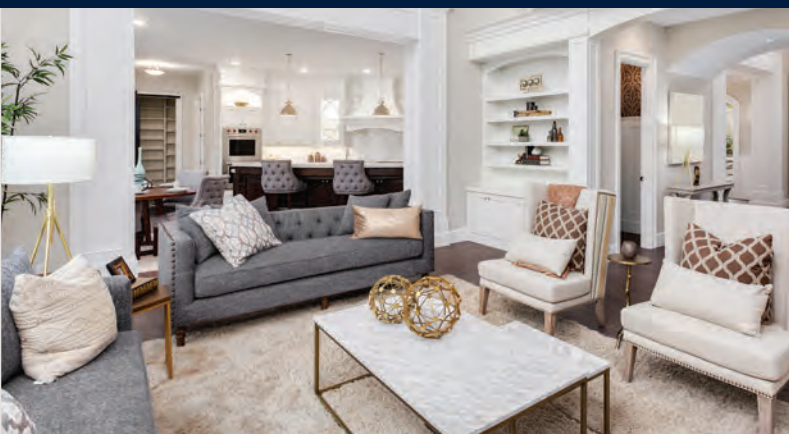

Visionary Collection

Modern | Confident | Minimal



Industry-leading warranties for peace of mind.

LIFETIME
LIMITED
WARRANTY
TRANSFERABLE

Uniquely designed by Therma-Tru, Classic Craft complete entryway systems are backed by an industry-leading 1x transferable lifetime limited warranty from the entry door brand building professionals choose most.* This comprehensive lifetime limited warranty can be transferred one time to a new owner, should you ever sell your home.

10 YEAR
LIMITED
WARRANTY
TRANSFERABLE

In addition, Classic Craft entryways with our handcrafted and professionally applied PrismaGuard premium stain or paint are backed by a transferable 10-year limited finish warranty – Therma-Tru's best. The balance of this finish warranty can transfer to a second owner.

Learn about our industry-leading warranties at thermatru.com/warranty.



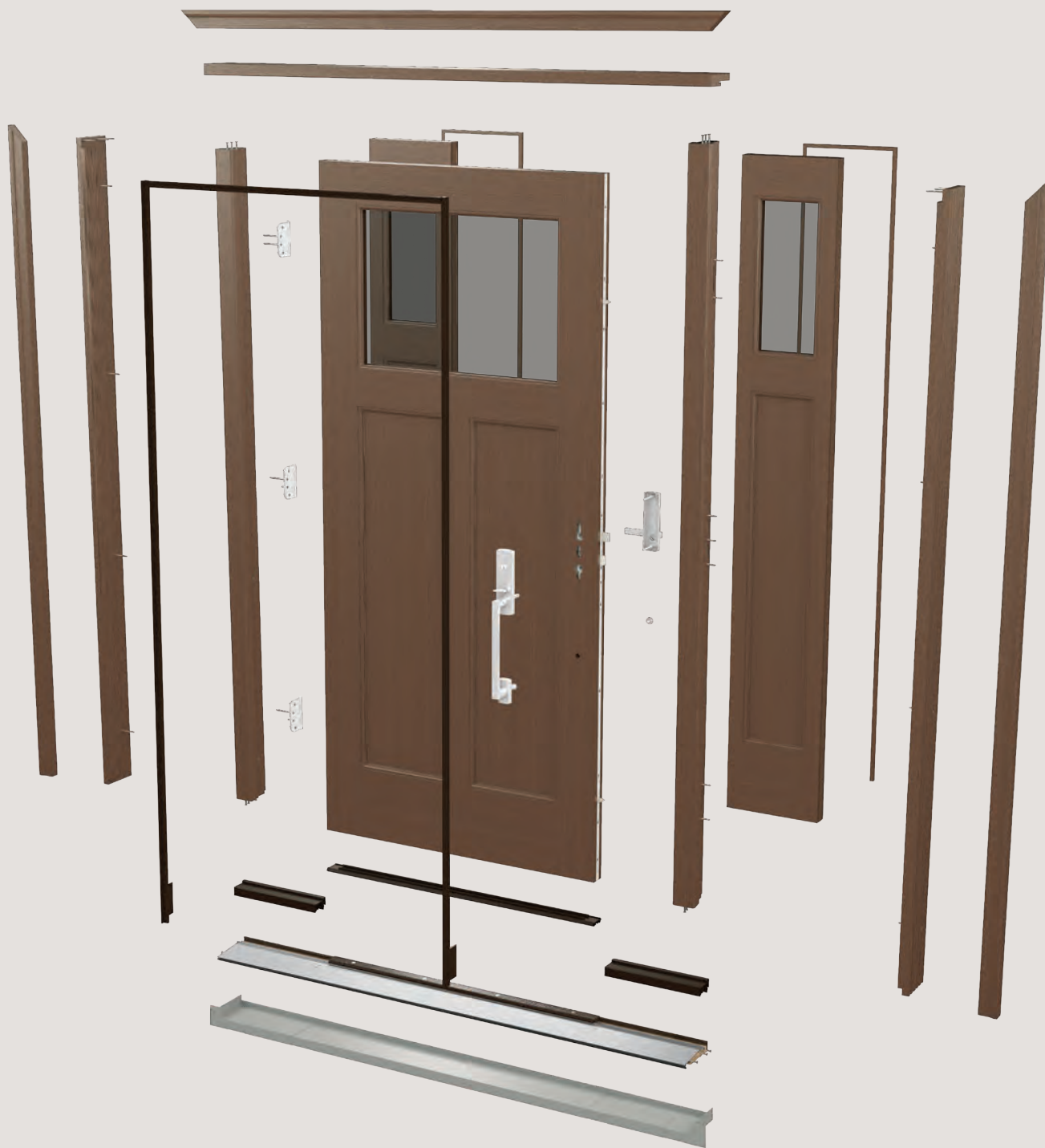

Next-level engineering.

Classic Craft complete entryway systems are designed with a full suite of premium-grade components, including ball-bearing hinges, medium-reach weatherstrip, 7-shape corner seal pads and more. Each piece is engineered with craftsman precision to create an unrivaled entry experience built to perform for a lifetime.

Premium construction, inside and out.

Highlighting the best of craftsmanship and innovation, Classic Craft premium entryways boast impressive, well-designed features and remarkable construction. The inner workings of each Classic Craft door lay the foundation for exceptional strength, security, energy efficiency and long-term performance you can depend on for years to come.



Engineered for Moisture Protection

Features composite top and bottom rails and solid hardwood edges for increased moisture and rot protection all the way around the door.



Designed with Authenticity

Features construction identical to wood doors with narrow stiles and rails, and flush-glazed glass options that are more than 10% wider* to welcome more natural light into the home.



Tested to Withstand Mother Nature

Designed and rigorously tested to withstand and protect from the damaging effects of harsh weather conditions.

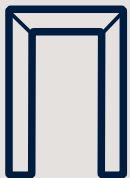

Therma-Tru® Door Frame

Created specifically for Thermo-Tru doors to deliver an entire entry system designed and engineered to work together to resist leaks and drafts, and help maintain energy efficiency and weather resistance.

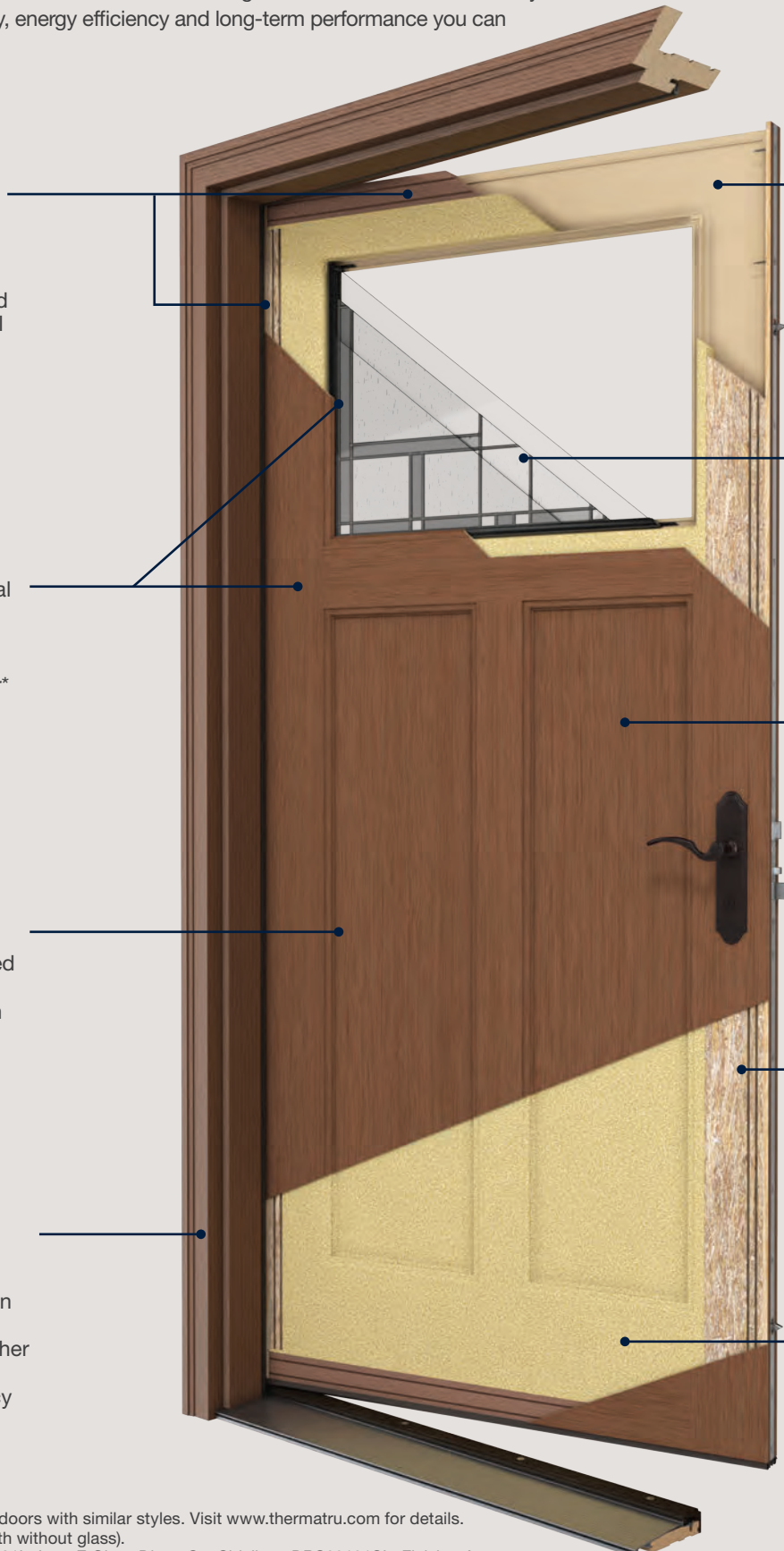

*Comparison of Classic Craft to other standard fiberglass doors with similar styles. Visit www.thermatru.com for details.

**Comparison of R-Values of fiberglass to wood doors (both without glass).

Right Page Top: Classic Craft Walnut Grain Door – CCW8901L; Low-E Glass Direct Set Sidelite – DRS82131SL, Finish – Acorn

Right Page Middle: Classic Craft Mahogany Grain, Low-E Glass, Door – CCR30020; Provincial Glass, Sidelites – CCR3408SL;

Low-E Glass, Transom – 19220T, Finish – Driftwood

Right Page Bottom: Classic Craft Canvas Door – CCV220, Low-E Glass, Sidelites – CCV100SL, Finish – Indigo



Designed for Long-Term Performance

Features fiberglass skins that are 46% thicker* for added durability and better long-term performance.



Triple-Pane Construction

Most decorative, privacy and textured glass panels are enclosed between tempered glass, offering superior quality and thermal performance.



Crafted for a True-to-Wood Appearance

Revolutionary AccuGrain technology replicates authentic natural wood textures for a look and feel that is virtually indistinguishable from real wood.



Built for Strength and Security

Constructed with a 4" wide board of engineered lumber that runs the full length of the locking side of the door for a solid natural wood feel that makes Classic Craft doors 50% stronger and 30% heavier.*



Constructed for Energy Efficiency

Built with a high-performance polyurethane foam core that is four times more energy efficient than wood.**



True-to-Wood Origins

Revel in the handcrafted look and feel of a premium fiberglass entryway with true-to-wood origins. Discover exquisite textures with grains hand selected from the finest natural wood species and meticulously recreated with our revolutionary AccuGrain® technology.

AccuGrain®
TECHNOLOGY

Fir Grain

Formerly Classic-Craft American Style

Designed to echo the grain of the largest species of American Hemlocks – the Western Hemlock tree – found in lush coastal rainforests of the Pacific Northwest.

Walnut Grain

Crafted to reflect the prized hardwood of the mighty Black Walnut trees, these doors feature a horizontal grain with natural movement accented by delicate arches and cathedrals.

Mahogany Grain

Formerly Classic-Craft Mahogany & Rustic

Derived from the finest African and Honduran Mahogany, blending rustic influences with exotic roots to build upon the rich history of one of the most renowned woods in the world.

Oak Grain

Designed to emulate the unique characteristics of Red Oak trees, embodying the look and feel of one of the most popular wood grains of all time.

Canvas

Inspired by the world's most exquisite masterpieces and designed with the architectural character of finely sanded wood.

Unique style.
Unmatched craftsmanship.

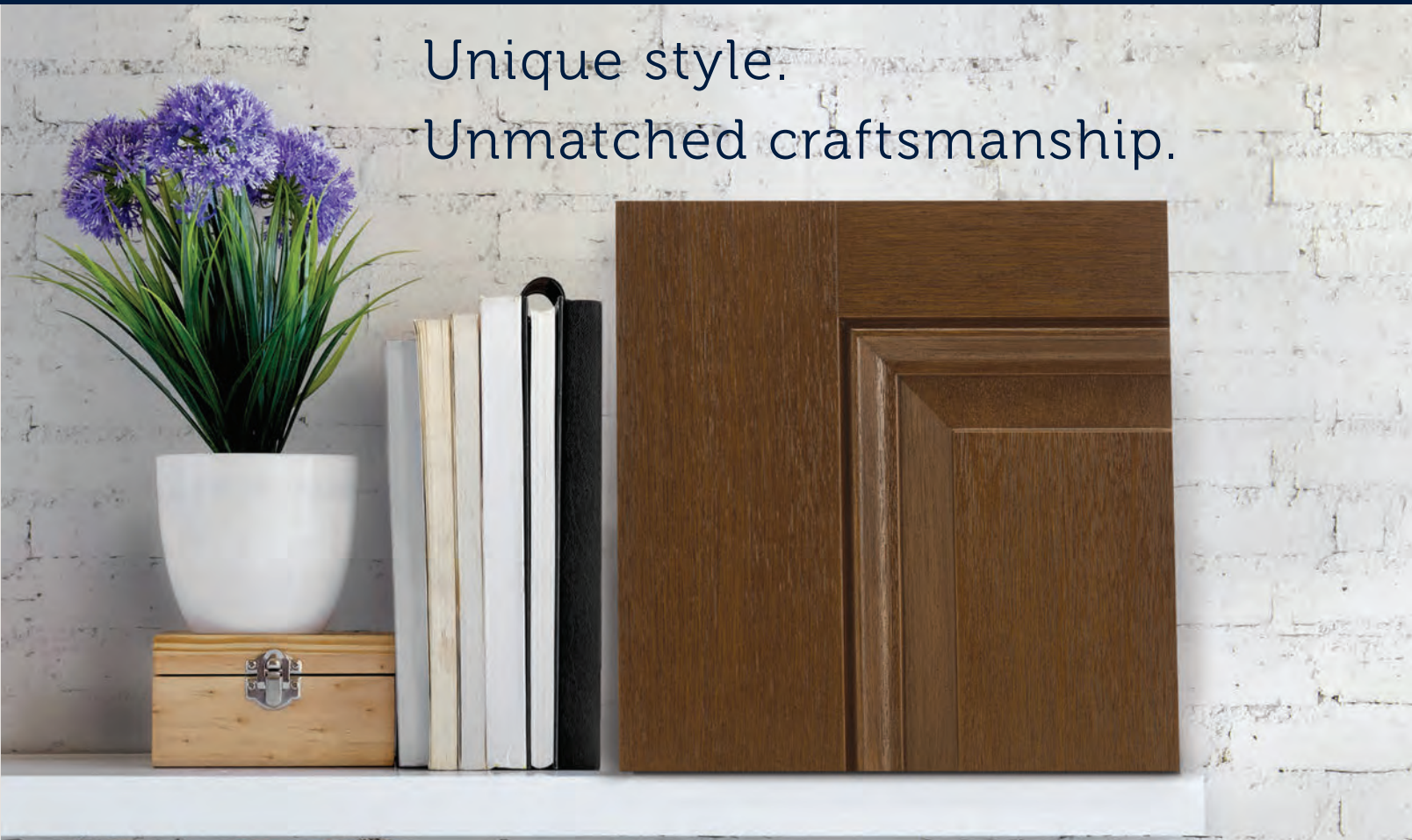

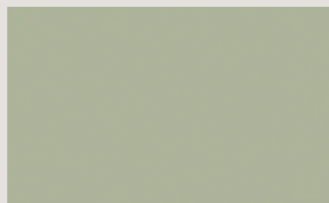
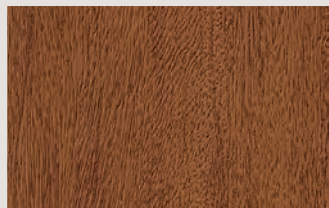
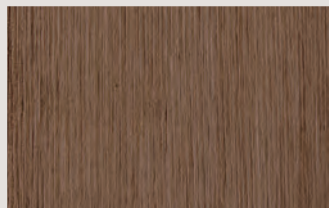

ARTÍSSA

Collection

Rooted in simple nostalgia, the Artíssa Collection pays homage to the handmade culture of the American Arts and Crafts movement. Highlighting the beauty of straight-forward design, this selection of premium Classic Craft® doors features clean lines, Shaker styling and Craftsman-inspired glass for a casual and welcoming approach to the entryway.

CASUAL

RELAXED

SIMPLE

Left Page: Classic Craft Oak Grain, Arborwatch Glass, Door – CC1423, Sidelites – CC1423SL, Transom – ABRT, Finish – Barley
 Right Page: Classic Craft Fir Grain, Low-E Glass with SDLs, Door – CCA230, Sidelites – CCA210SL, Finish – Raven



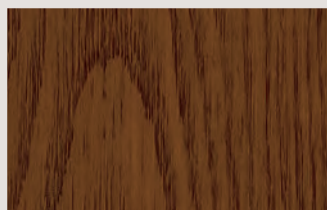

FOUNDERS

Collection

A revival of traditional and rustic styling, the Founders Collection honors the historic significance of classically inspired design. Taking a more decorative approach to the entryway, this selection of premium Classic Craft doors includes curved and arched details, embellished panel embossments and intricate glass designs for a noteworthy entrance with enduring style.

TRADITIONAL
TIME-HONORED
DECORATIVE

Left Page: Classic Craft Mahogany Grain, Lucerna Glass, Door - CCM82802, Finish - New Earth
Right Page: Classic Craft Mahogany Grain, Low-E Glass with SDLs, Doors - CCM8306CAL, CCM8306CAR, Finish - Acorn



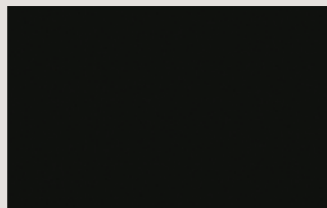

VISIONARY

Collection

Artfully inspired with a confident edge, the Visionary Collection pushes the envelope of design for the next generation. Focusing on a streamlined aesthetic with a modern flair, this collection of premium Classic Craft. doors reimagines the entry with sleek lines, forward-thinking designs and minimalist details for an entrance that exudes confidence with bold appeal.

MODERN

CONFIDENT

MINIMAL

Left Page: Classic Craft Fir Grain, Satin Etch Glass with SDLs, Door – CCA2310XE, Sidelite – CCA2310XESL, Finish – Flaxseed
 Right Page: Classic Craft Walnut Grain Door – CCW8906R; Low-E Glass Direct Set Sidelite – DRS82131SL, Finish – Lynx



Decorative & Specialty Glass Designs



Homeward™

The balanced Mission-style pattern of Homeward invites light to cascade through its distinctive ① clear bevels, ② seeded glass and ③ gray artique glass. An ideal complement for a Transitional home design.

Glass Shapes



Glass Privacy Rating



Black Nickel



Brushed Nickel

*Only available in Classic Craft Oak grain.

Note: Glass privacy ratings may be more or less than indicated, based on glass design and size of glass. Glass designs may differ from depiction due to size and hand craftsmanship of glass. See your Therma-Tru seller or visit www.thermatru.com for details on glass privacy ratings and designs.

Arborwatch[®]

An eclectic interpretation of the Arts and Crafts movement, Arborwatch combines **1** narrow reeded glass, **2** M seedy glass, **3** waterglass and coming in a symmetrical arrangement accented by **4** pale amber glass, **5** amber antique glass and **6** clear bevels.

Glass Shapes

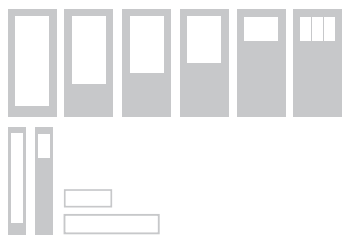

Glass Privacy Rating



Note: The use of pale amber and amber antique glass varies based on glass size. Refer to the image on page 54 to see an example on a home.



Black Nickel



Brushed Nickel

Arcadia[™]

With its timeless petal design, Arcadia combines **1** gray baroque glass, **2** seeded glass, **3** clear curved bevels and coming for a distinctive display that evokes a simpler time.

Glass Shapes

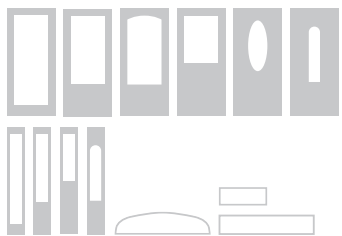

Glass Privacy Rating



Black Nickel



Brushed Nickel



Brass*

Decorative & Specialty Glass Designs

Augustine®

Augustine's swirl leaf design adds that touch of elegance. Made of round wrought iron and 1 granite glass for the ultimate in privacy, Augustine pays homage to classic English styling.

Glass Shapes



Corresponding sidelites feature Granite glass without wrought iron.

Glass Privacy Rating

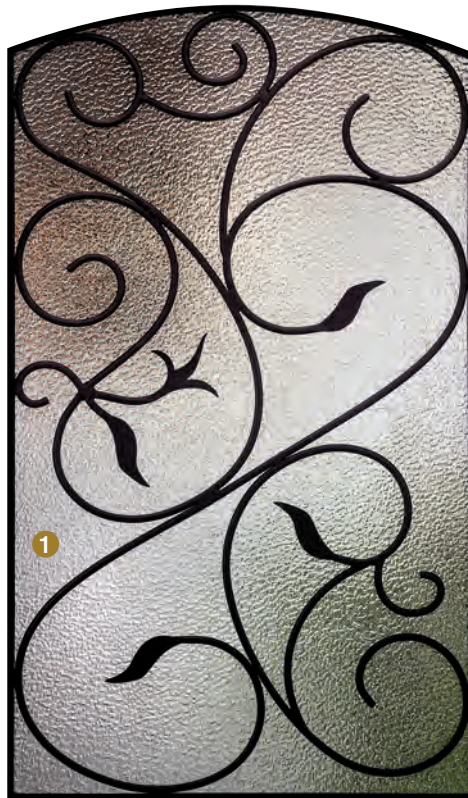

Wrought Iron

Note: Features a lite frame with an authentic wrought iron look in a black finish. Refer to the image on page 314 to see an example on a home.

Borrassa®

A statement of strength and beauty, Borrassa combines linear and curved wrought iron with 1 hammered glass for the ultimate in privacy. Wrought iron decorative accents add an authentic Old World feel to this stately design.

Glass Shapes



Corresponding sidelites feature Hammered glass without wrought iron.

Glass Privacy Rating



Wrought Iron

Note: Features a lite frame with an authentic wrought iron look in a black finish. Refer to the image on page 48 to see an example on a home.

*Only available in Classic Craft Oak grain.

Note: Glass privacy ratings may be more or less than indicated, based on glass design and size of glass. Glass designs may differ from depiction due to size and hand craftsmanship of glass. See your Therma-Tru seller or visit www.thermatru.com for details on glass privacy ratings and designs.

Provincial™

A unique diamond-based motif features **1** double waterglass, **2** clear bevels and coming surrounded by a **3** gray baroque glass border. Provincial captivates with stunning clarity.

Glass Shapes



Glass Privacy Rating



Black Nickel



Brushed Nickel



Brass*

Longford™

The traditional design of Longford integrates a hint of a Celtic knot with **1** seeded glass, **2** clear bevels, **3** granite glass and coming. A timeless design ideal for entries where modest privacy is desired.

Glass Shapes



Glass Privacy Rating



Black Nickel



Brushed Nickel

Decorative & Specialty Glass Designs

Cambridge™

Ornate and enchanting, Cambridge exhibits a traditional 19th century-inspired elegance with modest privacy using **1** glue chip glass, **2** clear curved bevels, **3** double waterglass and coming.

Glass Shapes

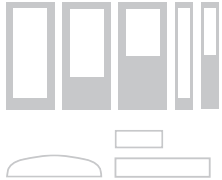

Glass Privacy Rating



Black Nickel



Brushed Nickel



Brass

Lucerna®

Named for the beauty of light it reflects, Lucerna glass presents an elegant, updated fleur-de-lis pattern in a spectrum of **1** curved, **2** diamond and **3** rectangular bevels surrounded by smooth, swirling **4** barn wood and heavily textured **5** diamond border glass.

Glass Shapes

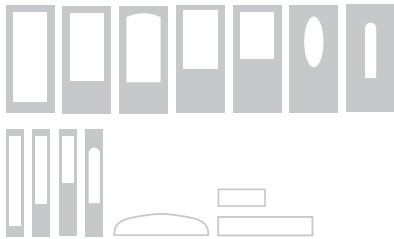

Glass Privacy Rating



Black Nickel



Brushed Nickel

Note: Glass privacy ratings may be more or less than indicated, based on glass design and size of glass. Glass designs may differ from depiction due to size and hand craftsmanship of glass. See your Therma-Tru seller or visit www.thermatru.com for details on glass privacy ratings and designs.

Right Page: Classic Craft Mahogany Grain, Zaha Glass, Door – CCR1838, Finish – Shale

Zaha®

Structured right angles are offset by dynamic curves in this high-energy design. Zaha features ① oceana and ② seedy glass, ③ clear and ④ multifaceted bevels, and coming to create a refreshing and unexpected elegance that appeals to Contemporary home styles.

Glass Shapes



Glass Privacy Rating



Black Nickel



Brushed Nickel



Privacy & Textured Glass



Reeded (XK)

A vertical, linear textured glass that provides modest privacy and an on-trend aesthetic.

Glass Privacy Rating
1
10
7



Geometric (XG)

A sleek cubic texture with a unique multidimensional view and ever-changing perspectives.

Glass Privacy Rating
1
10
7



Satin Etch (XE)

A fine-textured pearlescent glass that delivers a pure, simple design aesthetic.

Glass Privacy Rating
1
10
10



Chord (XC)

A vertical flowing pattern reminiscent of waves on the water.

Glass Privacy Rating
1
10
10



Note: Glass privacy ratings may be more or less than indicated, based on glass design and size of glass. Glass designs may differ from depiction due to size and hand craftsmanship of glass. See your Therma-Tru seller or visit www.thermatru.com for details on glass privacy ratings and designs.



Chinchilla (XJ)

A free-flowing configuration, presenting quiet lines and curves.

Glass Privacy Rating 10



Rainglass (XR)

An elegantly fashioned glass, featuring ripples of cascading water.

Glass Privacy Rating 8 10



Granite (XN)

A coarse-grained arrangement with surface detail over the entirety of the glass.

Glass Privacy Rating 10



Also Available:

Low-E Glass



In cold weather, Low-E glass reflects the heat back inside to help keep your home warm.

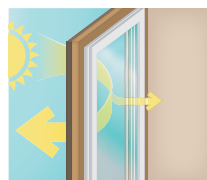

In warm weather, Low-E glass reflects the sun's rays off of the glass to help keep your home cool.

Divided Lites

Enhance the beauty of any home with divided lites for entry and patio doors. Increase curb appeal by coordinating with window grid patterns for a cohesive look that suits the home's architectural details.

Simulated Divided Lites (SDLs)

Wood-grained or smooth SDL bars adhere to the interior and exterior panes of tempered glass and can be stained or painted to complement the door and home. Look for the (■) icon.

4-¼" and 5-½" flat profile bars are also used on solid-panel doors as door divider bars (DDBs). Look for the (■) icon.



(107.95 mm / 4.25 in.)
Look for the (■) and (■) icons.

(139.70 mm / 5.5 in.)
Look for the (■) and (■) icons.

Note: Some door styles use a combination of 4-¼" and 5-½" divider bars. Look for the (■) and (■) icons.



Mahogany Grain



Canvas

Fir Grain





Flush-Glazed Sticking Profiles

EnLiten™ flush-glazed designs feature a seamless look with simple profile around the glass. Look for the (🔥) and (💧) icons.

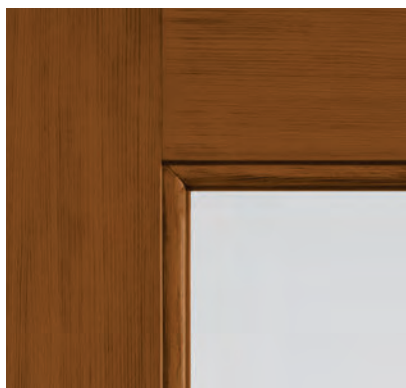

Detailed Sticking
Look for the (🔥) icon.



Square Sticking
Look for the (💧) icon.

Dentil Shelves

Complete the look with a dentil shelf for true Craftsman appeal or to complement other architectural elements around the house. Includes 4- and 16-block options.



Classic Craft. Fir Grain 4-Block Dentil Shelf



Classic Craft. Fir Grain 4-Block Dentil Shelf*



Classic Craft. Fir Grain 16-Block Dentil Shelf



Classic Craft. Canvas 4-Block Dentil Shelf



4-Block Dentil Shelf
Shown on 3'6" x 8'0" door.



4-Block Dentil Shelf
Shown on 3'0" x 8'0" door.

*Pairs with 3'6" wide doors.

Bottom: Classic Craft Fir Grain, Low-E Glass with SDLs, Door – CCA230, Dentil Shelf

Right Page, Left: Classic Craft Mahogany Grain Door – CCR205; Smooth-Star, Clear Glass with GBGs, Sidelites – S1170SL, Transom – 19220T; Clavos

Right Page, Right: Classic Craft Mahogany Grain Door – CCR100R, Strap Hinges, Finish – Lynx



Clavos & Strap Hinges

Add a finishing touch of rustic flavor with decorative hardware in an authentic, hand-forged wrought iron look with a black finish. Includes pyramid and round clavos, as well as strap hinges.



Fir Grain

Formerly Classic-Craft
American Style

Mahogany Grain

Formerly Classic-Craft
Mahogany & Rustic

Oak Grain

Canvas

Homeward™



Mahogany*
CCR9925
3'0" x 6'8"



Mahogany
CCR9925SL
12" x 6'8"
14" x 6'8"



Oak
CC9925
3'0" x 6'8"



Oak
CC9925SL
12" x 6'8"
14" x 6'8"



Canvas
CCV9925
3'0" x 6'8"



Canvas
CCV911SL
12" x 6'8"
14" x 6'8"

Arborwatch®



Mahogany*
CCR1423
3'0" x 6'8"



Mahogany
CCR1423SL
12" x 6'8"
14" x 6'8"



Oak
CC1423
3'0" x 6'8"



Oak
CC1423SL
12" x 6'8"
14" x 6'8"



Canvas
CCV1423
3'0" x 6'8"



Canvas
CCV1423SL
12" x 6'8"
14" x 6'8"

Key

- 🔥 Flush-Glazed Glass with Detailed Sticking (FG)
- 💧 Flush-Glazed Glass with Square Sticking (FG)
- ◆ Black Nickel Caming (1D)
- ⦿ Brushed Nickel Caming (1C)
- 3 Simulated Divided Lites (SDLF3)
- 4 Simulated Divided Lites (SDLF4)
- 5 Simulated Divided Lites (SDLF5)
- E Elevated 10" Bottom Rail Options

Privacy & Textured Glass Options

Add the code to the blank in the style number for the desired door and glass combination. For details on glass options, see pages 66–67.

- XK = Reeded
- XJ = Chinchilla
- XG = Geometric
- XR = Rainglass
- XE = Satin Etch
- XN = Granite
- XC = Chord

*Formerly Classic-Craft Rustic.

**Formerly Classic-Craft American Style.

***Not available with Reeded (XK) or Geometric (XG) glass.

Note: See page 299 for important product details that may help with your purchase decision.

Privacy & Textured



Fir**

CCA2350_*** CCA82350_***
 ▲ S E ▲ S E
 3'0" x 6'8" 3'0" x 8'0"



Fir**

CCA2360_*** CCA82360_***
 ▲ S E ▲ S E
 3'0" x 6'8" 3'0" x 8'0"

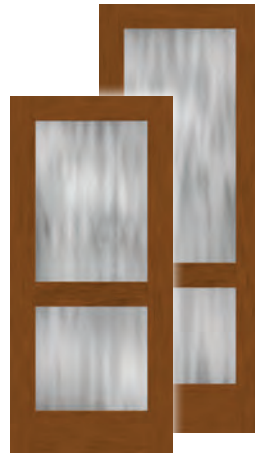

Fir**

CCA2370_*** CCA82370_***
 ▲ S E ▲ S E
 3'0" x 6'8" 3'0" x 8'0"



Fir**

CCA4900_*** CCA84900_***
 ▲ S E ▲ S E
 3'0" x 6'8" 3'0" x 8'0"

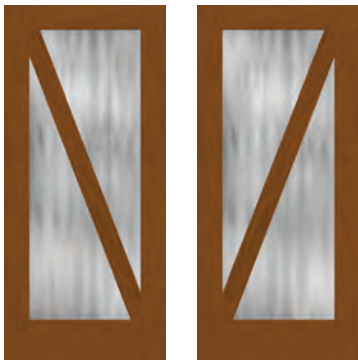

Fir**

CCA4910L_*** CCA4910R_***
 ▲ S E ▲ S E
 3'0" x 6'8" 3'0" x 6'8"

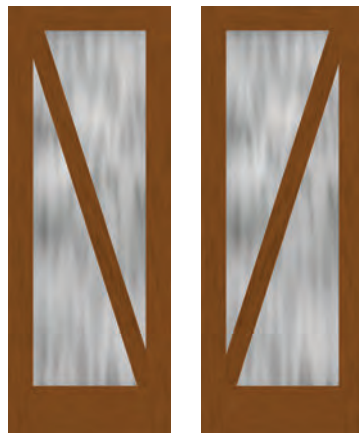

Fir**

CCA84910L_*** CCA84910R_***
 ▲ S E ▲ S E
 3'0" x 8'0" 3'0" x 8'0"



Fir**

CCA4920L_*** CCA4920R_***
 ▲ S E ▲ S E
 3'0" x 6'8" 3'0" x 6'8"

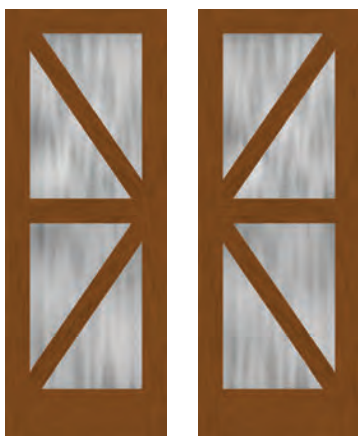

Fir**

CCA84920L_*** CCA84920R_***
 ▲ S E ▲ S E
 3'0" x 8'0" 3'0" x 8'0"



Fir**

CCA4930_*** CCA84930_***
 ▲ S E ▲ S E
 3'0" x 6'8" 3'0" x 8'0"



Fir**

CCA4940_*** CCA84940_***
 ▲ S E ▲ S E
 3'0" x 6'8" 3'0" x 8'0"



Fir**







CCA2400_SL CCA82400_SL
 ▲ S E ▲ S E
 12" x 6'8" 12" x 8'0"
 14" x 6'8" 14" x 8'0"

continued

Fir Grain

Formerly Classic-Craft
American Style

Key

-  Flush-Glazed Glass with Square Sticking (FG)
-  Low-E Glass (LE)
-  Simulated Divided Lites (SDLF3)
-  Simulated Divided Lites (SDLF4)
-  Simulated Divided Lites (SDLF5)
-  Elevated 10" Bottom Rail Options

LOW-E



Fir*

CCA2350
  
3'0" x 6'8"

CCA82350
   
3'0" x 8'0"



Fir*

CCA2360
  
3'0" x 6'8"

CCA82360
   
3'0" x 8'0"



Fir*

CCA2370
  
3'0" x 6'8"

CCA82370
   
3'0" x 8'0"



Fir*

CCA4900
  
3'0" x 6'8"

CCA84900
   
3'0" x 8'0"

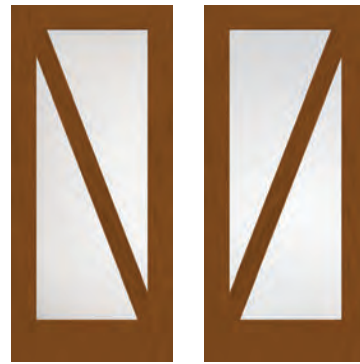

Fir*

CCA4910L
  
3'0" x 6'8"

CCA4910R
  
3'0" x 6'8"



Fir*

CCA84910L
   
3'0" x 8'0"

CCA84910R
   
3'0" x 8'0"



Fir*

CCA4920L
  
3'0" x 6'8"

CCA4920R
  
3'0" x 6'8"

*Formerly Classic-Craft American Style.

Note: See page 299 for important product details that may help with your purchase decision.

Right Page: Classic Craft Fir Grain, Satin Etch Glass with SDLs, Door – CCA4900XE, Sidelites – CCA2400XESL



Fir*

CCA84920L	CCA84920R
☀️ ⚡️ ⚡️ E	☀️ ⚡️ ⚡️ E
3'0" x 8'0"	3'0" x 8'0"



Fir*

CCA4930	CCA84930
☀️ ⚡️ ⚡️ E	☀️ ⚡️ ⚡️ E
3'0" x 6'8"	3'0" x 8'0"



Fir*

CCA4940	CCA84940
☀️ ⚡️ ⚡️ E	☀️ ⚡️ ⚡️ E
3'0" x 6'8"	3'0" x 8'0"



Fir*

CCA2400SL	CCA82400SL
☀️ ⚡️ ⚡️ E	☀️ ⚡️ ⚡️ E
12" x 6'8"	12" x 8'0"
14" x 6'8"	14" x 8'0"



continued



Mahogany Grain

Formerly Classic-Craft
Mahogany & Rustic



Oak Grain



Canvas

Key

-  Flush-Glazed Glass with Detailed Sticking (FG)
-  Flush-Glazed Glass with Square Sticking (FG)
-  Black Nickel Caming (1D)
-  Brushed Nickel Caming (1C)
-  Brass Caming (A)
-  Wrought Iron (W)

Arcadia



Mahogany*

CCR30029**
3'0" x 6'8"



Mahogany

CCR3409SL**
 12" x 6'8"
14" x 6'8"



Oak

CC109
3'0" x 6'8"



Oak

CC2060SL
 12" x 6'8"
14" x 6'8"



Canvas

CCV10029**
3'0" x 6'8"



Canvas

CCV109SL**
 12" x 6'8"
14" x 6'8"

Augustine



Mahogany*

CCR30027
3'0" x 6'8"



Mahogany

CCR3400XNSL
 12" x 6'8"
14" x 6'8"



Canvas

CCV10027
3'0" x 6'8"

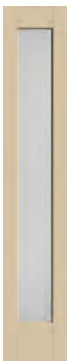

Canvas

CCV100XNSL
 12" x 6'8"
14" x 6'8"

Borrassa



Mahogany*

CCR1528
3'0" x 6'8"



Mahogany

CCR3400XHSL
 12" x 6'8"
14" x 6'8"

*Formerly Classic-Craft Rustic.

**Not available in brass caming.

Note: See page 299 for important product details that may help with your purchase decision.



Canvas

CCV1528
3'0" x 6'8"



Canvas

CCV100XHSL
12" x 6'8"
14" x 6'8"

Provincial™



Mahogany*

CCR30028**
3'0" x 6'8"



NEW

Mahogany

CCR3408SL**
12" x 6'8"
14" x 6'8"



Oak

CC107
3'0" x 6'8"



Oak

CC2040SL
12" x 6'8"
14" x 6'8"



Canvas

CCV10028**
3'0" x 6'8"



Canvas

CCV108SL**
12" x 6'8"
14" x 6'8"

Longford™



Mahogany*

CCR30023
3'0" x 6'8"



NEW

Mahogany

CCR3407SL
12" x 6'8"
14" x 6'8"



Canvas

CCV10023
3'0" x 6'8"



Canvas

CCV103SL
12" x 6'8"
14" x 6'8"

Cambridge™



Mahogany*

CCR30026
3'0" x 6'8"



NEW

Mahogany

CCR3406SL
12" x 6'8"
14" x 6'8"



Oak

CC106
3'0" x 6'8"



Oak

CC2044SL
12" x 6'8"
14" x 6'8"



Canvas

CCV10026
3'0" x 6'8"



Canvas

CCV106SL
12" x 6'8"
14" x 6'8"

continued



Fir Grain

Formerly Classic-Craft
American Style



Mahogany Grain

Formerly Classic-Craft
Mahogany & Rustic



Oak Grain

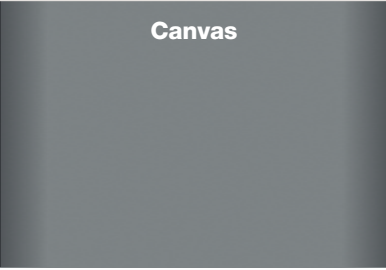

Canvas

Key

- Flush-Glazed Glass with Detailed Sticking (FG)
- Flush-Glazed Glass with Square Sticking (FG)
- Low-E Glass (LE)
- Black Nickel Caming (1D)
- Brushed Nickel Caming (1C)
- Simulated Divided Lites (SDL)
- Simulated Divided Lites (SDLF3)
- Simulated Divided Lites (SDLF4)
- Simulated Divided Lites (SDLF5)
- Simulated Divided Lites (SDLF6)
- Elevated 10" Bottom Rail Options

Privacy & Textured Glass Options

Add the code to the blank in the style number for the desired door and glass combination. For details on glass options, see pages 66-67.

- XK = Reeded
- XG = Geometric
- XE = Satin Etch
- 78
- XC = Chord
- XJ = Chinchilla
- XR = Rainglass
- XN = Granite

Lucerna

Mahogany*	Mahogany	Oak	Oak	Canvas
CCR10022 3'0" x 6'8"	CCR3412SL ▲ 12" x 6'8" 14" x 6'8"	CC10022 3'0" x 6'8"	CC3412SL ▲ 12" x 6'8" 14" x 6'8"	CCV10022 3'0" x 6'8"

LOW-E

Canvas	Mahogany*	Mahogany	Mahogany	Oak
CCV3412SL ▲ 12" x 6'8" 14" x 6'8"	CCR30020 ★ 3'0" x 6'8"	CCR3400SL ▲★ 12" x 6'8" 14" x 6'8"	CCR2025SL ▲★FG 12" x 6'8" 14" x 6'8"	CC100 ★ 3'0" x 6'8"

Oak	Canvas	Canvas	Canvas
CC2020SL ▲★ 12" x 6'8" 14" x 6'8"	CCV10020 ★ 3'0" x 6'8"	CCV100SL ▲★ 12" x 6'8" 14" x 6'8"	CCV950SL ▲★FG 12" x 6'8" 14" x 6'8"

*Formerly Classic-Craft Rustic.
**Formerly Classic-Craft American Style.
Note: See page 299 for important product details that may help with your purchase decision.

Zaha. ♦ ♦ ♦



Mahogany*

CCR1851
3'0" x 6'8"



NEW
Mahogany

CCR1851SL
12" x 6'8"
14" x 6'8"



Canvas

CCV1851
3'0" x 6'8"

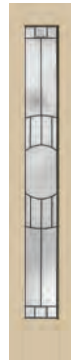

Canvas

CCV1851SL
12" x 6'8"
14" x 6'8"

Privacy & Textured

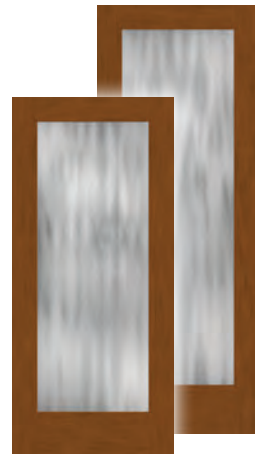

Fir**

CCA2400
3'0" x 6'8"

CCA82400
3'0" x 8'0"

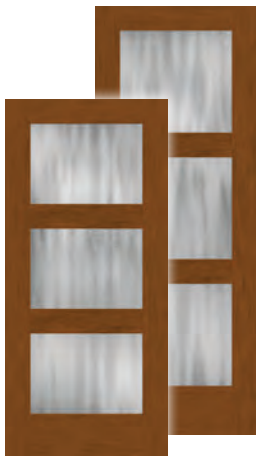

Fir**

CCA2300
3'0" x 6'8"

CCA82300
3'0" x 8'0"

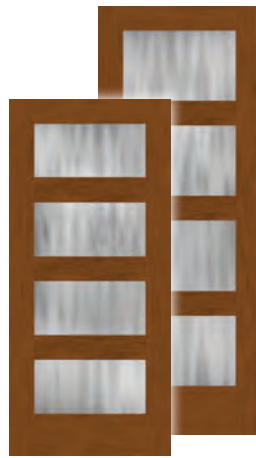

Fir**

CCA2310
3'0" x 6'8"

CCA82310
3'0" x 8'0"

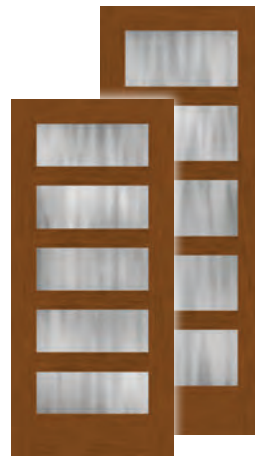

Fir**

CCA2320
3'0" x 6'8"

CCA82320
3'0" x 8'0"



Fir**

CCA2330
3'0" x 6'8"

CCA82330
3'0" x 8'0"

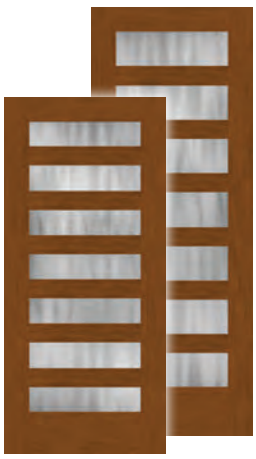

Fir**

CCA2340
3'0" x 6'8"

CCA82340
3'0" x 8'0"

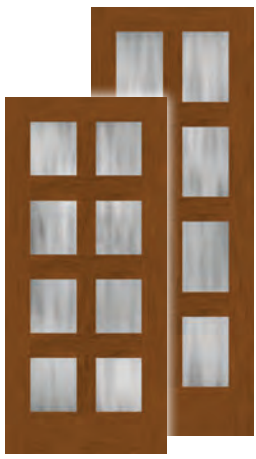

Fir**

CCA2380
3'0" x 6'8"

CCA82380
3'0" x 8'0"



Fir**

CCA2400_SL
12" x 6'8"
14" x 6'8"

CCA82400_SL
12" x 8'0"
14" x 8'0"



Fir**

CCA2300_SL
12" x 6'8"
14" x 6'8"







CCA82300_SL
12" x 8'0"
14" x 8'0"

continued

Fir Grain

Formerly Classic-Craft American Style

Key

-  Flush-Glazed Glass with Square Sticking (FG)
-  Low-E Glass (LE)
-  Simulated Divided Lites (SDLF3)
-  Simulated Divided Lites (SDLF4)
-  Simulated Divided Lites (SDLF5)
-  Elevated 10" Bottom Rail Options

Privacy & Textured Glass Options





Add the code to the blank in the style number for the desired door and glass combination. For details on glass options, see pages 66–67.

- XK = Reeded
- XG = Geometric
- XE = Satin Etch
- XC = Chord
- XJ = Chinchilla
- XR = Rainglass
- XN = Granite

Privacy & Textured





Fir*

CCA2310_SL	CCA82310_SL
  12" x 6'8"	  12" x 8'0"
14" x 6'8"	14" x 8'0"







Fir*

CCA2320_SL	CCA82320_SL
  12" x 6'8"	  12" x 8'0"
14" x 6'8"	14" x 8'0"



Fir*

CCA2330_SL	CCA82330_SL
  12" x 6'8"	  12" x 8'0"
14" x 6'8"	14" x 8'0"



Fir*

CCA2340_SL	CCA82340_SL
  12" x 6'8"	  12" x 8'0"
14" x 6'8"	14" x 8'0"

LOW-E



Fir*

CCA2400	CCA82400
  3'0" x 6'8"	   3'0" x 8'0"



Fir*

CCA2300	CCA82300
   3'0" x 6'8"	    3'0" x 8'0"



Fir*

CCA2310	CCA82310
   3'0" x 6'8"	    3'0" x 8'0"



Fir*

CCA2320	CCA82320
   3'0" x 6'8"	    3'0" x 8'0"



Fir*

CCA2330	CCA82330
   3'0" x 6'8"	    3'0" x 8'0"

*Formerly Classic-Craft American Style.

Note: See page 299 for important product details that may help with your purchase decision.

Right Page: Classic Craft Fir Grain, Low-E Glass with SDLs, Door – CCA2340, Sidelites – CCA2400SL, Finish – Rustic Clay, ©TheHouseDesigners.com



Fir*

CCA2340
 ▲ ★ 3
 3'0" x 6'8"

CCA82340
 ▲ ★ 3 E
 3'0" x 8'0"

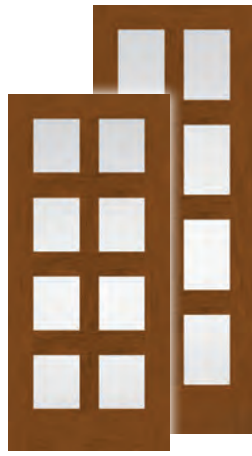

Fir*

CCA2380
 ▲ ★ 5
 3'0" x 6'8"

CCA82380
 ▲ ★ 5 E
 3'0" x 8'0"



Fir*

CCA2400SL
 ▲ ★
 12" x 6'8"
 14" x 6'8"

CCA82400SL
 ▲ ★
 12" x 8'0"
 14" x 8'0"



Fir*

CCA2300SL
 ▲ ★ 4
 12" x 6'8"
 14" x 6'8"

CCA82300SL
 ▲ ★ 4
 12" x 8'0"
 14" x 8'0"



Fir*

CCA2310SL
 ▲ ★ 4
 12" x 6'8"
 14" x 6'8"

CCA82310SL
 ▲ ★ 4
 12" x 8'0"
 14" x 8'0"



Fir*

CCA2320SL
 ▲ ★ 3
 12" x 6'8"
 14" x 6'8"

CCA82320SL
 ▲ ★ 3
 12" x 8'0"
 14" x 8'0"



Fir*

CCA2330SL
 ▲ ★ 3
 12" x 6'8"
 14" x 6'8"

CCA82330SL
 ▲ ★ 3
 12" x 8'0"
 14" x 8'0"



Fir*

CCA2340SL
 ▲ ★ 3
 12" x 6'8"
 14" x 6'8"

CCA82340SL
 ▲ ★ 3
 12" x 8'0"
 14" x 8'0"





Mahogany Grain

Formerly Classic-Craft
Mahogany & Rustic



Oak Grain

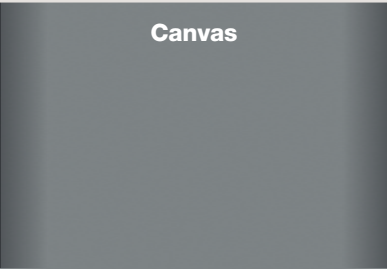

Canvas

Key

- Flush-Glazed Glass with Detailed Sticking (FG)
- Flush-Glazed Glass with Square Sticking (FG)
- Low-E Glass (LE)
- Black Nickel Caming (1D)
- Brushed Nickel Caming (1C)
- Simulated Divided Lites (SDL)
- Simulated Divided Lites (SDLF6)

Privacy & Textured Glass Options

Add the code to the blank in the style number for the desired door and glass combination. For details on glass options, see pages 66-67.

- XK = Reeded
- XG = Geometric
- XE = Satin Etch
- XC = Chord
- XJ = Chinchilla
- XR = Rainglass
- XN = Granite

Homeward™



Mahogany

CCM2801
3'0" x 6'8"

CCM82801
3'0" x 8'0"



Mahogany

CCM9923
3'0" x 6'8"



Mahogany

CCR9925SL
12" x 6'8"
14" x 6'8"

CCR89925SL
12" x 8'0"
14" x 8'0"



Oak

CC9922
3'0" x 6'8"

CC89922
3'0" x 8'0"



Oak

CC9925SL
12" x 6'8"
14" x 6'8"

CC89925SL
12" x 8'0"
14" x 8'0"



Canvas

CCV9922
3'0" x 6'8"

CCV89922
3'0" x 8'0"



Canvas

CCV911SL
12" x 6'8"
14" x 6'8"

CCV8111SL
12" x 8'0"
14" x 8'0"

Arborwatch®



Mahogany

CCM1419
3'0" x 6'8"



Mahogany

CCM81418
3'0" x 8'0"



Mahogany

CCR1423SL
12" x 6'8"
14" x 6'8"

CCR81423SL
12" x 8'0"
14" x 8'0"



Oak

CC1418
3'0" x 6'8"

CC81418
3'0" x 8'0"

*Not available with Geometric (XG) or Chinchilla (XJ) glass.

**Not available with Reeded (XK) glass.

***Not available with Reeded (XK) or Satin Etch (XE) glass.

Note: See page 299 for important product details that may help with your purchase decision.



Oak

CC1423SL	CC81423SL
▲	▲
12" x 6'8"	12" x 8'0"
14" x 6'8"	14" x 8'0"



Canvas

CCV1418	CCV81418
3'0" x 6'8"	3'0" x 8'0"



Canvas

CCV1423SL	CCV81423SL
▲	▲
12" x 6'8"	12" x 8'0"
14" x 6'8"	14" x 8'0"

Privacy & Textured



Mahogany

CCM2800_*	CCM82800_*
▲	▲
3'0" x 6'8"	3'0" x 8'0"



Mahogany

CCM2804_*	CCM82804_*
▲	▲
3'0" x 6'8"	3'0" x 8'0"



Mahogany

CCM2806_*	CCM82806_*
▲	▲
3'0" x 6'8"	3'0" x 8'0"



Mahogany

CCM2812_*	CCM82815_*
▲	▲
3'0" x 6'8"	3'0" x 8'0"



Mahogany

CCR3400_SL	CCR8000_SL
▲	▲
12" x 6'8"	12" x 8'0"
14" x 6'8"	14" x 8'0"



Mahogany

CCR2025_SL	CCR82035_SL
▲	▲
12" x 6'8"	12" x 8'0"
14" x 6'8"	14" x 8'0"



Oak

CC2020_SL**	CC8000_SL***
▲	▲
12" x 6'8"	12" x 8'0"
14" x 6'8"	14" x 8'0"



Canvas

CCV05020XC	CCV05020XN
3'0" x 6'8"	



Canvas

CCV100_SL**	CCV8100_SL***
▲	▲
12" x 6'8"	12" x 8'0"
14" x 6'8"	14" x 8'0"



Canvas

CCV950_SL**	CCV8950_SL***
▲	▲
12" x 6'8"	12" x 8'0"
14" x 6'8"	14" x 8'0"

LOW-E



Mahogany

CCM2800	CCM82800
▲	▲
3'0" x 6'8"	3'0" x 8'0"

continued



Mahogany Grain

Formerly Classic-Craft
Mahogany & Rustic



Oak Grain



Canvas

Key

- Flush-Glazed Glass with Detailed Sticking (FG)
- Flush-Glazed Glass with Square Sticking (FG)
- Low-E Glass (LE)
- Black Nickel Caming (1D)
- Brushed Nickel Caming (1C)
- Brass Caming (1A)
- Wrought Iron (W)
- Simulated Divided Lites (SDL)
- Simulated Divided Lites (SDLF6)

LOW-E



NEW

NEW

Mahogany

CCM2804 | CCM82804

 3'0" x 6'8" | 3'0" x 8'0"



NEW

NEW

Mahogany

CCM2806 | CCM82806

 3'0" x 6'8" | 3'0" x 8'0"



NEW

NEW

Mahogany

CCM2812 | CCM82815

 3'0" x 6'8" | 3'0" x 8'0"



NEW

NEW

Mahogany

CCR3400SL | CCR8000SL

 12" x 6'8" | 12" x 8'0"
 14" x 6'8" | 14" x 8'0"



NEW

NEW

Mahogany

CCR2025SL | CCR82035SL

 12" x 6'8" | 12" x 8'0"
 14" x 6'8" | 14" x 8'0"



NEW

Oak

CC90 | CC890

 3'0" x 6'8" | 3'0" x 8'0"



NEW

Oak

CC2020SL | CC8000SL

 12" x 6'8" | 12" x 8'0"
 14" x 6'8" | 14" x 8'0"



NEW

Canvas

CCV05020 | CCV805020

 3'0" x 6'8" | 3'0" x 8'0"



NEW

Canvas

CCV950SL | CCV8950SL

 12" x 6'8" | 12" x 8'0"
 14" x 6'8" | 14" x 8'0"



NEW

Canvas

CCV100SL | CCV8100SL

 12" x 6'8" | 12" x 8'0"
 14" x 6'8" | 14" x 8'0"

*Not available in brass caming.
 Note: See page 299 for important product details that may help with your purchase decision.

Founders Collection

For transoms, see pages 122–123.

Arcadia[™]



Mahogany

CCM209*
3'0" x 6'8"



Mahogany

CCM894*
3'0" x 8'0"



Mahogany

CCM309*
3'0" x 6'8"



Mahogany

CCR3409SL*
12" x 6'8"
14" x 6'8"



Mahogany

CCR8009SL*
12" x 8'0"
14" x 8'0"

CCM3309SL*
10" x 6'8"
12" x 6'8"
14" x 6'8"



Oak

CC99
3'0" x 6'8"

CC899
3'0" x 8'0"



Oak

CC2060SL
12" x 6'8"
14" x 6'8"

CC8009SL
12" x 8'0"
14" x 8'0"



Canvas

CCV05029*
3'0" x 6'8"

CCV805029*
3'0" x 8'0"



Canvas

CCV109SL*
12" x 6'8"
14" x 6'8"

CCV8109SL*
12" x 8'0"
14" x 8'0"

Augustine[®]



Mahogany

CCM1485
3'0" x 6'8"



Mahogany

CCM805027
3'0" x 8'0"



Mahogany

CCM1495
3'0" x 6'8"



Mahogany

CCR3400XNSL
12" x 6'8"
14" x 6'8"

CCR8000XNSL
12" x 8'0"
14" x 8'0"



Canvas

CCV05027
3'0" x 6'8"

CCV805027
3'0" x 8'0"

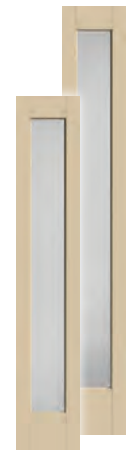

Canvas

CCV100XNSL
12" x 6'8"
14" x 6'8"

CCV8100XNSL
12" x 8'0"
14" x 8'0"

continued



Mahogany Grain

Formerly Classic-Craft
Mahogany & Rustic



Oak Grain

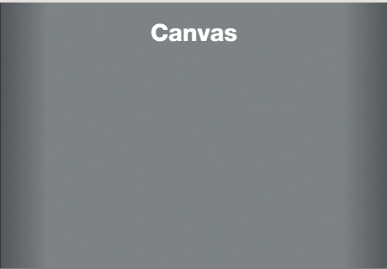

Canvas

Key

-  Flush-Glazed Glass with Detailed Sticking (FG)
-  Flush-Glazed Glass with Square Sticking (FG)
-  Black Nickel Caming (1D)
-  Brushed Nickel Caming (1C)
-  Brass Caming (1A)
-  Wrought Iron (W)

Borrassa® x



Mahogany

CCM1475
3'0" x 6'8"



Mahogany

CCM81519
3'0" x 8'0"







Mahogany

CCM1465
3'0" x 6'8"



Mahogany

CCR3400XHSL | CCR8000XHSL
 12" x 6'8" |  12" x 8'0"
 14" x 6'8" |  14" x 8'0"







Canvas

CCV1519 | CCV81519
3'0" x 6'8" | 3'0" x 8'0"



Canvas

CCV100XHSL | CCV8100XHSL
 12" x 6'8" |  12" x 8'0"
 14" x 6'8" |  14" x 8'0"

Longford™



Mahogany

CCM203
3'0" x 6'8"



Mahogany

CCM892
3'0" x 8'0"







Mahogany

CCM303
3'0" x 6'8"





Mahogany

CCR3407SL | CCR8007SL
 12" x 6'8" |  12" x 8'0"
 14" x 6'8" |  14" x 8'0"



Mahogany

CCM3303SL
 10" x 6'8"
 12" x 6'8"
 14" x 6'8"



Canvas

CCV05023 | CCV805023
3'0" x 6'8" | 3'0" x 8'0"

*Not available in brass caming.

Note: See page 299 for important product details that may help with your purchase decision.

Lucerna[®] ◆◆



Canvas

CCV103SL | CCV8103SL
 ▲ 12" x 6'8" | ▲ 12" x 8'0"
 14" x 6'8" | 14" x 8'0"



Mahogany

CCM2802 | CCM82802
 ▲ 3'0" x 6'8" | ▲ 3'0" x 8'0"



Mahogany

CCM204
 3'0" x 6'8"



Mahogany

CCM302
 3'0" x 6'8"



Mahogany

CCR3412SL | CCR8102SL
 ▲ 12" x 6'8" | ▲ 12" x 8'0"
 14" x 6'8" | 14" x 8'0"



Mahogany

CCM3302SL
 ▲ 10" x 6'8"
 12" x 6'8"
 14" x 6'8"

Oak

CC922 | CC898
 3'0" x 6'8" | 3'0" x 8'0"

Oak

CC3412SL | CC8102SL
 ▲ 12" x 6'8" | ▲ 12" x 8'0"
 14" x 6'8" | 14" x 8'0"

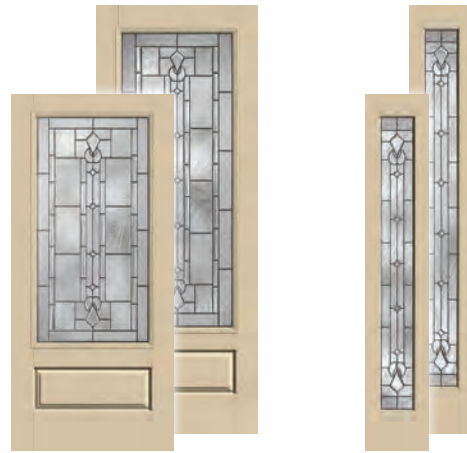

Canvas

CCV05022 | CCV805022
 3'0" x 6'8" | 3'0" x 8'0"

Canvas

CCV3412SL | CCV8102SL
 ▲ 12" x 6'8" | ▲ 12" x 8'0"
 14" x 6'8" | 14" x 8'0"

Provincial[™] ◆◆



Mahogany

CCR3408SL* | CCR8008SL*
 ▲ 12" x 6'8" | ▲ 12" x 8'0"
 14" x 6'8" | 14" x 8'0"



Oak

CC97 | CC897
 3'0" x 6'8" | 3'0" x 8'0"



Oak

CC2040SL | CC8007SL
 ▲ 12" x 6'8" | ▲ 12" x 8'0"
 14" x 6'8" | 14" x 8'0"



Canvas

CCV05028* | CCV805028*
 3'0" x 6'8" | 3'0" x 8'0"

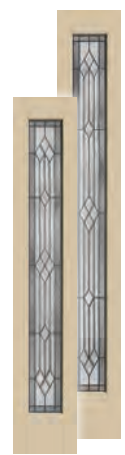

Canvas

CCV108SL* | CCV8108SL*
 ▲ 12" x 6'8" | ▲ 12" x 8'0"
 14" x 6'8" | 14" x 8'0"

continued



Mahogany Grain

Formerly Classic-Craft
Mahogany & Rustic



Oak Grain

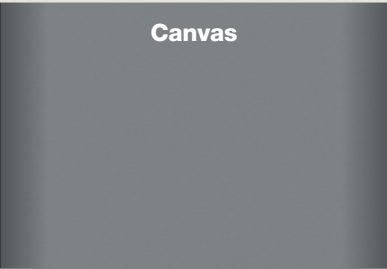

Canvas

Key

- Flush-Glazed Glass with Detailed Sticking (FG)
- Flush-Glazed Glass with Square Sticking (FG)
- Low-E Glass (LE)
- Black Nickel Caming (1D)
- Brushed Nickel Caming (1C)
- Brass Caming (1A)

Privacy & Textured Glass Options

Add the code to the blank in the style number for the desired door and glass combination. For details on glass options, see pages 66-67.

XC = Chord
XN = Granite

Cambridge™



NEW

NEW

Mahogany

CCR3406SL	CCR8006SL
12" x 6'8"	12" x 8'0"
14" x 6'8"	14" x 8'0"



Oak

CC96	CC896
3'0" x 6'8"	3'0" x 8'0"



Oak

CC2044SL	CC8006SL
12" x 6'8"	12" x 8'0"
14" x 6'8"	14" x 8'0"



Canvas

CCV05026	CCV805026
3'0" x 6'8"	3'0" x 8'0"



Canvas

CCV106SL	CCV8106SL
12" x 6'8"	12" x 8'0"
14" x 6'8"	14" x 8'0"

Privacy & Textured



Mahogany

CCM200
3'0" x 6'8"



Mahogany

CCM300
3'0" x 6'8"

Low-E



Mahogany

CCM200
3'0" x 6'8"



Mahogany

CCM300
3'0" x 6'8"



Mahogany

CCM3300SL
10" x 6'8"
12" x 6'8"
14" x 6'8"

Note: See page 299 for important product details that may help with your purchase decision.

Right Page: Classic Craft Mahogany Grain, Zaha Glass, Door – CCM82803;
Low-E Glass Direct Set Sidelites – DRS82131SL, Finish – Lynx

Visionary Collection

For transoms, see pages 122–123.

Zaha. ♦ ♦ ♦



Mahogany
CCM2803 | **CCM82803**
 3'0" x 6'8" | 3'0" x 8'0"



Mahogany
CCM1844
 3'0" x 6'8"



Mahogany
CCM1842
 3'0" x 6'8"



Mahogany
CCR1851SL | **CCR81851SL**
 12" x 6'8" | 12" x 8'0"
 14" x 6'8" | 14" x 8'0"



Mahogany
CCM1843SL
 10" x 6'8"
 12" x 6'8"
 14" x 6'8"



Canvas
CCV1843 | **CCV81843**
 3'0" x 6'8" | 3'0" x 8'0"



Canvas
CCV1851SL | **CCV81851SL**
 12" x 6'8" | 12" x 8'0"
 14" x 6'8" | 14" x 8'0"





Mahogany Grain

Formerly Classic-Craft
Mahogany & Rustic

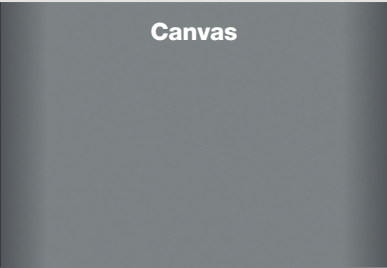

Canvas

Key

- ☀ Low-E Glass (LE)
- ◆ Black Nickel Caming (1D)
- ▣ Brushed Nickel Caming (1C)

Privacy & Textured Glass Options

Add the code to the blank in the style number for the desired door and glass combination. For details on glass options, see pages 66-67.

XC = Chord
XN = Granite

Homeward™



Mahogany*

CCR9921 3'0" x 6'8"
CCR89921 3'0" x 8'0"
3'6" x 8'0"



Mahogany*

CCR9919 3'0" x 6'8"
CCR89919 3'0" x 8'0"
3'6" x 8'0"



Mahogany*

CCR9918 3'0" x 6'8"
CCR89918 3'0" x 8'0"



Mahogany*

CCR822218 3'0" x 8'0"
3'6" x 8'0"



Canvas

CCV9919 3'0" x 6'8"
CCV89919 3'0" x 8'0"



Canvas

CCV9918 3'0" x 6'8"
CCV89918 3'0" x 8'0"

Arborwatch®



Mahogany*

CCR1417 3'0" x 6'8"
CCR81417 3'0" x 8'0"
3'6" x 8'0"



Mahogany*

CCR1415 3'0" x 6'8"
CCR81415 3'0" x 8'0"
3'6" x 8'0"



Mahogany*

CCR1414 3'0" x 6'8"
CCR81414 3'0" x 8'0"

*Formerly Classic-Craft Rustic.

Note: See page 299 for important product details that may help with your purchase decision.

Right Page, Left: Classic Craft Mahogany Grain, Low-E Glass, Door – CCR20520

Right Page, Right: Classic Craft Mahogany Grain, Arborwatch Glass, Door – CCR1415, Sidelites – CCR1423SL, Finish – Mulberry



Mahogany*

CCR822214
3'0" x 8'0"
3'6" x 8'0"



Canvas

CCV1415 | CCV81415
3'0" x 6'8" | 3'0" x 8'0"



Canvas

CCV1414 | CCV81414
3'0" x 6'8" | 3'0" x 8'0"

Privacy & Textured



Mahogany*

CCR20520 | CCR820520
3'0" x 6'8" | 3'0" x 8'0"



Mahogany*

CCR822220
3'0" x 8'0"



Canvas

CCV20520 | CCV820520
3'0" x 6'8" | 3'0" x 8'0"

LOW-E



Mahogany*

CCR20520 | CCR820520
* 3'0" x 6'8" | * 3'0" x 8'0"
3'6" x 8'0"



Canvas

CCV20520 | CCV820520
* 3'0" x 6'8" | * 3'0" x 8'0"



continued

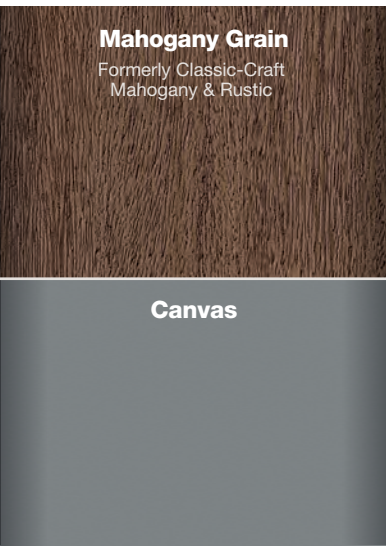

Key

- ◆ Black Nickel Caming (1D)
- Brushed Nickel Caming (1C)
- ✕ Wrought Iron (W)

Optional Accessories

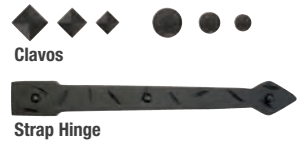

Arcadia™ ◆ ■



Mahogany*

CCR804029
3'0" x 8'0"



Mahogany*

CCR820529
3'0" x 8'0"



Mahogany*

CCR820029
3'0" x 8'0"



Mahogany*

CCR822229
3'0" x 8'0"



Canvas

CCV820529
3'0" x 8'0"



Canvas

CCV822029
3'0" x 8'0"

Augustine® ✕



Mahogany*

CCR04027 | CCR804027
3'0" x 6'8" | 3'0" x 8'0"
3'6" x 8'0"



Mahogany*

CCR20527 | CCR820527
3'0" x 6'8" | 3'0" x 8'0"
3'6" x 8'0"



Mahogany*

CCR20027 | CCR820027
3'0" x 6'8" | 3'0" x 8'0"



Mahogany*

CCR822227
3'0" x 8'0"
3'6" x 8'0"

*Formerly Classic-Craft Rustic.

Note: See page 299 for important product details that may help with your purchase decision.



Mahogany*

CCR04037 | CCR804037
3'0" x 6'8" | 3'0" x 8'0"
3'6" x 8'0"



Mahogany*

CCR20537 | CCR820537
3'0" x 6'8" | 3'0" x 8'0"
3'6" x 8'0"



Mahogany*

CCR20037 | CCR820037
3'0" x 6'8" | 3'0" x 8'0"



Mahogany*

CCR20537A | CCR820537A
3'0" x 6'8" | 3'0" x 8'0"
3'6" x 8'0"



Mahogany*

CCR20037A | CCR820037A
3'0" x 6'8" | 3'0" x 8'0"



Canvas

CCV20527 | CCV820527
3'0" x 6'8" | 3'0" x 8'0"



Canvas

CCV22027 | CCV822027
3'0" x 6'8" | 3'0" x 8'0"



Canvas

CCV20537 | CCV820537
3'0" x 6'8" | 3'0" x 8'0"

Borrassa[®]



Mahogany*

CCR1518 | CCR81518
3'0" x 6'8" | 3'0" x 8'0"
3'6" x 8'0"



Mahogany*

CCR1516 | CCR81516
3'0" x 6'8" | 3'0" x 8'0"
3'6" x 8'0"



Mahogany*

CCR1515 | CCR81515
3'0" x 6'8" | 3'0" x 8'0"



Mahogany*

CCR822215
3'0" x 8'0"
3'6" x 8'0"

continued



Mahogany Grain

Formerly Classic-Craft
Mahogany & Rustic

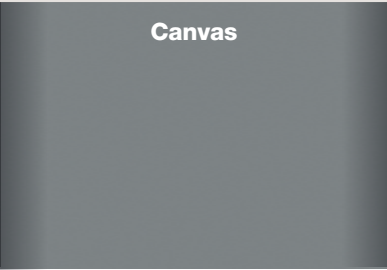

Canvas

Key

- ◆ Black Nickel Caming (1D)
- Brushed Nickel Caming (1C)
- ◆ Brass Caming (1A)
- ✕ Wrought Iron (W)

Optional Accessories



Clavos



Strap Hinge

Borrassa[®] ✕



Mahogany*

CCR1514 3'0" x 6'8" | CCR81514 3'0" x 8'0" 3'6" x 8'0"



Mahogany*

CCR1512 3'0" x 6'8" | CCR81512 3'0" x 8'0" 3'6" x 8'0"



Mahogany*

CCR1511 3'0" x 6'8" | CCR81511 3'0" x 8'0"



Mahogany*

CCR1512A 3'0" x 6'8" | CCR81512A 3'0" x 8'0" 3'6" x 8'0"



Mahogany*

CCR1511A 3'0" x 6'8" | CCR81511A 3'0" x 8'0"



Canvas

CCV1516 3'0" x 6'8" | CCV81516 3'0" x 8'0"



Canvas

CCV1515 3'0" x 6'8" | CCV81515 3'0" x 8'0"



Canvas

CCV1512 3'0" x 6'8" | CCV81512 3'0" x 8'0"



Provincial[™] ◆ ■

Mahogany*

CCR804028 3'0" x 8'0"

*Formerly Classic-Craft Rustic.

Note: See page 299 for important product details that may help with your purchase decision.



Mahogany*

CCR820528
3'0" x 8'0"



Mahogany*

CCR820028
3'0" x 8'0"



Mahogany*

CCR822228
3'0" x 8'0"



Canvas

CCV820528
3'0" x 8'0"



Canvas

CCV822028
3'0" x 8'0"

Longford™



Mahogany*

CCR04023 | CCR804023
3'0" x 6'8" | 3'0" x 8'0"



Mahogany*

CCR20523 | CCR820523
3'0" x 6'8" | 3'0" x 8'0"



Mahogany*

CCR20023 | CCR820023
3'0" x 6'8" | 3'0" x 8'0"



Mahogany*

CCR822223
3'0" x 8'0"



Canvas

CCV20523 | CCV820523
3'0" x 6'8" | 3'0" x 8'0"



Canvas

CCV22023 | CCV822023
3'0" x 6'8" | 3'0" x 8'0"

Cambridge™



Mahogany*

CCR804026
3'0" x 8'0"



Mahogany*

CCR820526
3'0" x 8'0"

continued



Mahogany Grain

Formerly Classic-Craft
Mahogany & Rustic

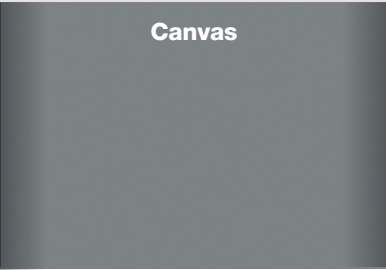

Canvas

Key

- ◆ Black Nickel Caming (1D)
- Brushed Nickel Caming (1C)
- ◆ Brass Caming (1A)

Privacy & Textured Glass Options

Add the code to the blank in the style number for the desired door and glass combination. For details on glass options, see pages 66-67.

XC = Chord
XN = Granite

Optional Accessories



Clavos



Strap Hinge

Cambridge™



Mahogany*

CCR820026
3'0" x 8'0"



Mahogany*

CCR822226
3'0" x 8'0"



Canvas

CCV820526
3'0" x 8'0"



Canvas

CCV822026
3'0" x 8'0"

Lucerna®



Mahogany*

CCR04022 | CCR804022
3'0" x 6'8" | 3'0" x 8'0"
3'6" x 8'0"



Mahogany*

CCR20522 | CCR820522
3'0" x 6'8" | 3'0" x 8'0"
3'6" x 8'0"



Mahogany*

CCR20022 | CCR820022
3'0" x 6'8" | 3'0" x 8'0"



Mahogany*

CCR822222
3'0" x 8'0"
3'6" x 8'0"



Mahogany*

CCR804032
3'0" x 8'0"



Mahogany*

CCR820532
3'0" x 8'0"



Mahogany*

CCR820032
3'0" x 8'0"

*Formerly Classic-Craft Rustic.

Note: See page 299 for important product details that may help with your purchase decision.



Mahogany*

CCR820532A
3'0" x 8'0"



Mahogany*

CCR820032A
3'0" x 8'0"



Canvas

CCV20522 | CCV820522
3'0" x 6'8" | 3'0" x 8'0"



Canvas

CCV22022 | CCV822022
3'0" x 6'8" | 3'0" x 8'0"



Canvas

CCV820532
3'0" x 8'0"

Privacy & Textured



Mahogany*

CCR04020 | CCR804020
3'0" x 6'8" | 3'0" x 8'0"



Mahogany*

CCR20020 | CCR820020
3'0" x 6'8" | 3'0" x 8'0"



Mahogany*

CCR804030
3'0" x 8'0"



Mahogany*

CCR820530
3'0" x 8'0"



Mahogany*

CCR820030
3'0" x 8'0"



Mahogany*

CCR820530A
3'0" x 8'0"



Canvas

CCV22020 | CCV822020
3'0" x 6'8" | 3'0" x 8'0"



Canvas

CCV820530
3'0" x 8'0"

continued



Mahogany Grain

Formerly Classic-Craft
Mahogany & Rustic

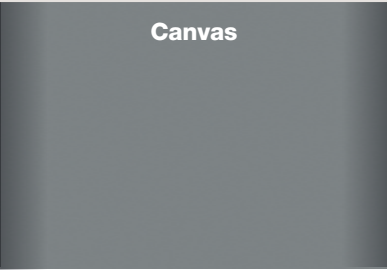

Canvas

Privacy & Textured



Mahogany

CCM302L_ | CCM302R_
3'0" x 6'8" | 3'0" x 6'8"



Mahogany

CCM8302L_ | CCM8302R_
3'0" x 8'0" | 3'0" x 8'0"

Key

- Flush-Glazed Glass with Square Sticking (FG)
- Low-E Glass (LE)
- Simulated Divided Lites (SDLF6)

Privacy & Textured Glass Options

Add the code to the blank in the style number for the desired door and glass combination. For details on glass options, see pages 66–67.

XE = Satin Etch XR = Rainglass
XC = Chord XN = Granite

Optional Accessories



Clavos



Strap Hinge



Mahogany

CCM304L_ | CCM304R_
 |
3'0" x 6'8" | 3'0" x 6'8"



Mahogany

CCM8304L_ | CCM8304R_
 |
3'0" x 8'0" | 3'0" x 8'0"



Mahogany

CCM303L_ | CCM303R_
 |
3'0" x 6'8" | 3'0" x 6'8"



Mahogany

CCM8303L_ | CCM8303R_
 |
3'0" x 8'0" | 3'0" x 8'0"

*Formerly Classic-Craft Rustic.

Note: See page 299 for important product details that may help with your purchase decision.



Mahogany

CCM301CAL_ CCM301CAR_
 ▲ 3'0" x 6'8" ▲ 3'0" x 6'8"



Mahogany

CCM8301CAL_ CCM8301CAR_
 ▲ 3'0" x 8'0" ▲ 3'0" x 8'0"



Mahogany

CCM305CAL_ CCM305CAR_
 ▲ 3'0" x 6'8" ▲ 3'0" x 6'8"



Mahogany

CCM8305CAL_ CCM8305CAR_
 ▲ 3'0" x 8'0" ▲ 3'0" x 8'0"



Mahogany

CCM306CAL_ CCM306CAR_
 ▲ 3'0" x 6'8" ▲ 3'0" x 6'8"



Mahogany

CCM8306CAL_ CCM8306CAR_
 ▲ 3'0" x 8'0" ▲ 3'0" x 8'0"

LOW-E



Mahogany*

CCR04020 CCR804020
 * 3'0" x 6'8" * 3'0" x 8'0"
 * 3'6" x 8'0"



Mahogany*

CCR20020 CCR820020
 * 3'0" x 6'8" * 3'0" x 8'0"



Mahogany*

CCR822220
 * 3'0" x 8'0"
 * 3'6" x 8'0"



Mahogany*

CCR804030
 * 3'0" x 8'0"

continued



Mahogany Grain

Formerly Classic-Craft
Mahogany & Rustic

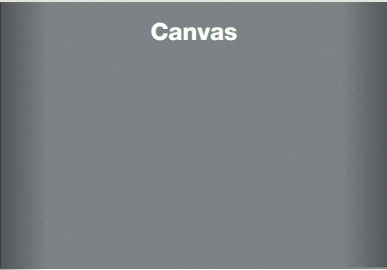

Canvas

Key

-  Flush-Glazed Glass with Square Sticking (FG)
-  Low-E Glass (LE)
-  Simulated Divided Lites (SDLF6)

Optional Accessories



Clavos



Strap Hinge

LOW-E



Mahogany*

CCR820530
*
3'0" x 8'0"



Mahogany*

CCR820030
*
3'0" x 8'0"



Mahogany*

CCR820530A
*
3'0" x 8'0"



Mahogany*

CCR820030A
*
3'0" x 8'0"



Canvas

CCV22020
*
3'0" x 6'8"



Canvas

CCV822020
*
3'0" x 8'0"



Mahogany

CCM302L
*
3'0" x 6'8"



CCM302R
*
3'0" x 6'8"



Mahogany

CCM8302L | CCM8302R
*
3'0" x 8'0" | 3'0" x 8'0"



Mahogany

CCM304L | CCM304R
*
3'0" x 6'8" | 3'0" x 6'8"

*Formerly Classic-Craft Rustic.

Note: See page 299 for important product details that may help with your purchase decision.



Mahogany

CCM8304L CCM8304R
 3'0" x 8'0" 3'0" x 8'0"



Mahogany

CCM303L CCM303R
 3'0" x 6'8" 3'0" x 6'8"



Mahogany

CCM8303L CCM8303R
 3'0" x 8'0" 3'0" x 8'0"



Mahogany

CCM301CAL CCM301CAR
 3'0" x 6'8" 3'0" x 6'8"



Mahogany

CCM8301CAL CCM8301CAR
 3'0" x 8'0" 3'0" x 8'0"



Mahogany

CCM305CAL CCM305CAR
 3'0" x 6'8" 3'0" x 6'8"



Mahogany

CCM8305CAL CCM8305CAR
 3'0" x 8'0" 3'0" x 8'0"



Mahogany

CCM306CAL CCM306CAR
 3'0" x 6'8" 3'0" x 6'8"



Mahogany

CCM8306CAL CCM8306CAR
 3'0" x 8'0" 3'0" x 8'0"

continued



Mahogany Grain

Formerly Classic-Craft
Mahogany & Rustic

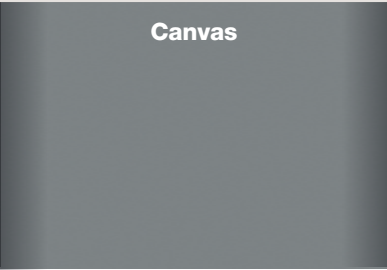

Canvas

Key

- ◆ Black Nickel Caming (1D)
- Brushed Nickel Caming (1C)

Zaha. ◆ ■



Mahogany*

CCR1841 3'0" x 6'8" | CCR81841 3'0" x 8'0"



Mahogany*

CCR1839 3'0" x 6'8" | CCR81839 3'0" x 8'0"



Mahogany*

CCR1838 3'0" x 6'8" | CCR81838 3'0" x 8'0"



Mahogany*

CCR822238 3'0" x 8'0"



Mahogany*

CCR81847 3'0" x 8'0"



Mahogany*

CCR81846 3'0" x 8'0"



Mahogany*

CCR81845 3'0" x 8'0"



Mahogany*

CCR81846A 3'0" x 8'0"



Mahogany*

CCR81845A 3'0" x 8'0"

*Formerly Classic-Craft Rustic.

Note: See page 299 for important product details that may help with your purchase decision.

Right Page: Classic Craft Canvas, Zaha Glass, Door – CCV1839; Clear Glass, Transom – 19200T



Canvas

CCV1839 | CCV81839
3'0" x 6'8" | 3'0" x 8'0"



Canvas

CCV1838 | CCV81838
3'0" x 6'8" | 3'0" x 8'0"

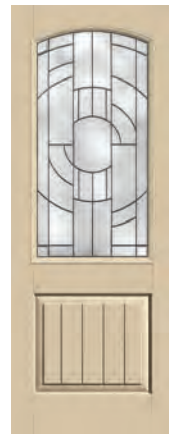

Canvas

CCV81846
3'0" x 8'0"



Artissa Collection



Mahogany Grain

Formerly Classic-Craft
Mahogany & Rustic



Oak Grain



Canvas

Key

-  Flush-Glazed Glass with Detailed Sticking (FG)
-  Black Nickel Caming (1D)
-  Brushed Nickel Caming (1C)
-  Brass Caming (1A)

Homeward™



Mahogany

CCM9926
3'0" x 6'8"



Oak

CC9926
3'0" x 6'8"



Canvas

CCV9926
3'0" x 6'8"

Arborwatch®



Mahogany

CCM1424
3'0" x 6'8"



Oak

CC1424
3'0" x 6'8"



Canvas

CCV1424
3'0" x 6'8"



*Not available in brass caming.

Note: See page 299 for important product details that may help with your purchase decision.

Bottom: Classic Craft Canvas, Homeward Glass, Door – CCV9926, Sidelites – CCM911SL, Finish – Cabernet

Founders Collection

For transoms, see pages 122–123.

Arcadia™



Mahogany

CCM609*
3'0" x 6'8"



Oak

CC45
2'8" x 6'8"
3'0" x 6'8"



Oak

CC2160SL
12" x 6'8"
14" x 6'8"



Canvas

CCV06029*
3'0" x 6'8"

Provincial™



Oak

CC47
2'8" x 6'8"
3'0" x 6'8"



Oak

CC2140SL
12" x 6'8"
14" x 6'8"



Canvas

CCV06028*
3'0" x 6'8"

Longford™



Mahogany

CCM603
3'0" x 6'8"



Canvas

CCV06023
3'0" x 6'8"

Cambridge™



Oak

CC44
2'8" x 6'8"
3'0" x 6'8"



Oak

CC2144SL
12" x 6'8"
14" x 6'8"



Canvas

CCV06026
3'0" x 6'8"

continued



Mahogany Grain

Formerly Classic-Craft
Mahogany & Rustic



Oak Grain

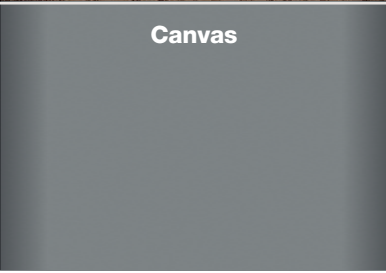

Canvas

Key

-  Flush-Glazed Glass with Detailed Sticking (FG)
-  Low-E Glass (LE)
-  Black Nickel Caming (1D)
-  Brushed Nickel Caming (1C)

Privacy & Textured Glass Options

Add the code to the blank in the style number for the desired door and glass combination. For details on glass options, see pages 66-67.

XE = Satin Etch

Lucerna



Mahogany

CCM612
3'0" x 6'8"



Oak

CC612
3'0" x 6'8"

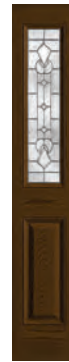

Oak

CC2122SL
 12" x 6'8"
14" x 6'8"



Canvas

CCV06022
3'0" x 6'8"

Privacy & Textured



Mahogany

CCM600XE
3'0" x 6'8"



Oak

CC48XE
3'0" x 6'8"



Canvas

CCV06020XE
3'0" x 6'8"

Low-E



Mahogany

CCM600
 3'0" x 6'8"



Oak

CC48
 2'8" x 6'8"
3'0" x 6'8"

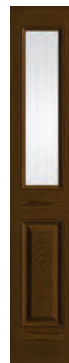

Oak

CC2120SL
  12" x 6'8"
14" x 6'8"



Canvas

CCV06020
 3'0" x 6'8"

Note: See page 299 for important product details that may help with your purchase decision.

Right Page: Classic Craft Mahogany Grain, Lucerna Glass, Door – CCM702, Sidelites – CCM3412SL, Finish – Mulberry

Oval Lites

Founders Collection

For transoms, see pages 122–123.

Arcadia™



Mahogany

CCM709
3'0" x 6'8"

Longford™



Mahogany

CCM703
3'0" x 6'8"

Lucerna™



Mahogany

CCM702
3'0" x 6'8"

Low-E



Mahogany

CCM700
★
3'0" x 6'8"







Fir Grain

Formerly Classic-Craft
American Style

Canvas

Key

-  Flush-Glazed Glass with Detailed Sticking (FG)
-  Flush-Glazed Glass with Square Sticking (FG)
-  Black Nickel Caming (1D)
-  Brushed Nickel Caming (1C)
-  Simulated Divided Lites (SDL)

Privacy & Textured Glass Options

Add the code to the blank in the style number for the desired door and glass combination. For details on glass options, see pages 66-67.

- XC = Chord XR = Rainglass
- XJ = Chinchilla XN = Granite

Optional Dentil Shelves

Available for all Classic Craft Craftsman Lite doors.



16-Block Dentil Shelf



4-Block Dentil Shelf



4-Block Dentil Shelf
Pairs with 3'6" wide doors.



4-Block Dentil Shelf

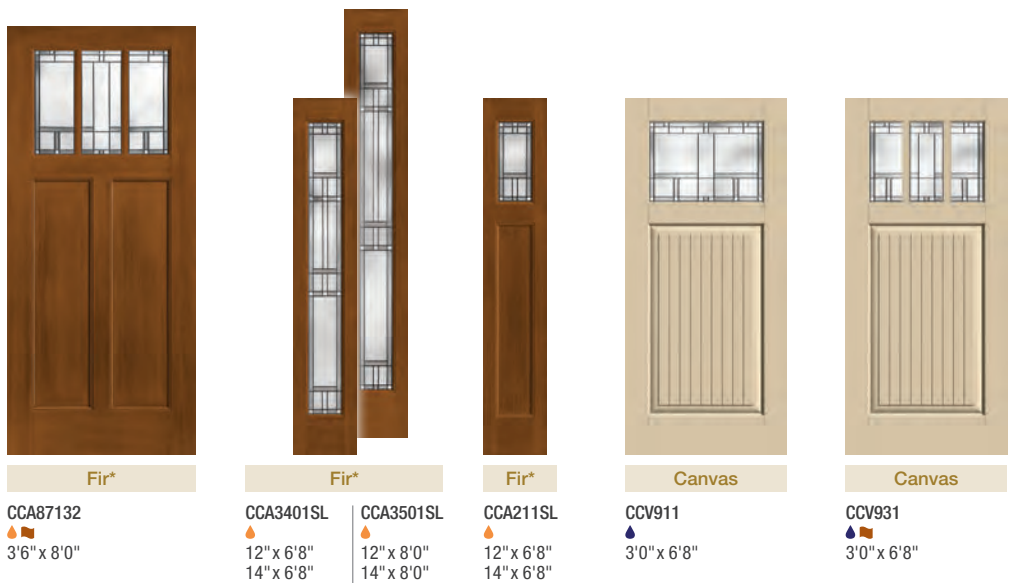

*Formerly Classic-Craft American Style.
Note: See page 299 for important product details that may help with your purchase decision.



Fir*

CCA9300
▲ ▲ 3'0" x 6'8"

CCA89300
▲ ▲ 3'0" x 8'0"



Fir*

CCA87131
▲ ▲ 3'6" x 8'0"



Fir*

CCA1423SL
▲ 12" x 6'8"
▲ 14" x 6'8"

CCA81423SL
▲ 12" x 8'0"
▲ 14" x 8'0"



Fir*

CCA9100SL
▲ 12" x 6'8"
▲ 14" x 6'8"



Canvas

CCV4100
● 3'0" x 6'8"



Canvas

CCV4300
● ▲ 3'0" x 8'0"

Privacy & Textured



Canvas

CCV1423SL
● 12" x 6'8"
▲ 14" x 6'8"



Canvas

CCV4100SL
● 12" x 6'8"
▲ 14" x 6'8"



Fir*

CCA210_▲ 3'0" x 6'8"

CCA8210_▲ 3'0" x 8'0"



Fir*

CCA87100XR
▲ 3'6" x 8'0"



Fir*

CCA220_▲ ▲ 3'0" x 6'8"

CCA8220_▲ ▲ 3'0" x 8'0"



Fir*

CCA87200XR
▲ ▲ 3'6" x 8'0"



Fir*

CCA230_▲ ▲ 3'0" x 6'8"

CCA8230_▲ ▲ 3'0" x 8'0"



Fir*

CCA87300XR
▲ ▲ 3'6" x 8'0"



Fir*

CCA240_▲ ▲ 3'0" x 6'8"

CCA8240_▲ ▲ 3'0" x 8'0"



continued

Fir Grain

Formerly Classic-Craft
American Style

Canvas

Key

-  Flush-Glazed Glass with Detailed Sticking (FG)
-  Flush-Glazed Glass with Square Sticking (FG)
-  Low-E Glass (LE)
-  Simulated Divided Lites (SDL)

Privacy & Textured Glass Options

Add the code to the blank in the style number for the desired door and glass combination. For details on glass options, see pages 66-67.

- XG = Geometric
- XJ = Chinchilla
- XE = Satin Etch
- XR = Rainglass
- XC = Chord
- XN = Granite

Optional Dentil Shelves

Available for all Classic Craft Craftsman Lite doors.



16-Block Dentil Shelf



4-Block Dentil Shelf



4-Block Dentil Shelf

Pairs with 3'6" wide doors.



4-Block Dentil Shelf

Privacy & Textured



Fir*

CCA87400XR
 
3'6" x 8'0"



Fir*

CCA260_*** CCA8260_***
   
3'0" x 6'8" 3'0" x 8'0"



Fir*

CCA87600XR
 
3'6" x 8'0"



Fir*

CCA3450_SL** CCA3560_SL**
   
12" x 6'8" 12" x 8'0"
14" x 6'8" 14" x 8'0"





Fir*

CCA3400_SL** CCA3500_SL**
 
12" x 6'8" 12" x 8'0"
14" x 6'8" 14" x 8'0"



Fir*

CCA220_SL***
 
12" x 6'8"
14" x 6'8"



Fir*

CCA210_SL***

12" x 6'8"
14" x 6'8"



Canvas

CCV910_***

3'0" x 6'8"



Canvas

CCV920_***
 
3'0" x 6'8"



Canvas

CCV930_***
 
3'0" x 6'8"



Canvas

CCV940_***
 
3'0" x 6'8"

*Formerly Classic-Craft American Style.

**Not available with Satin Etch (XE) glass.

***Not available with Geometric (XG) or Satin Etch (XE) glass.

Note: See page 299 for important product details that may help with your purchase decision.

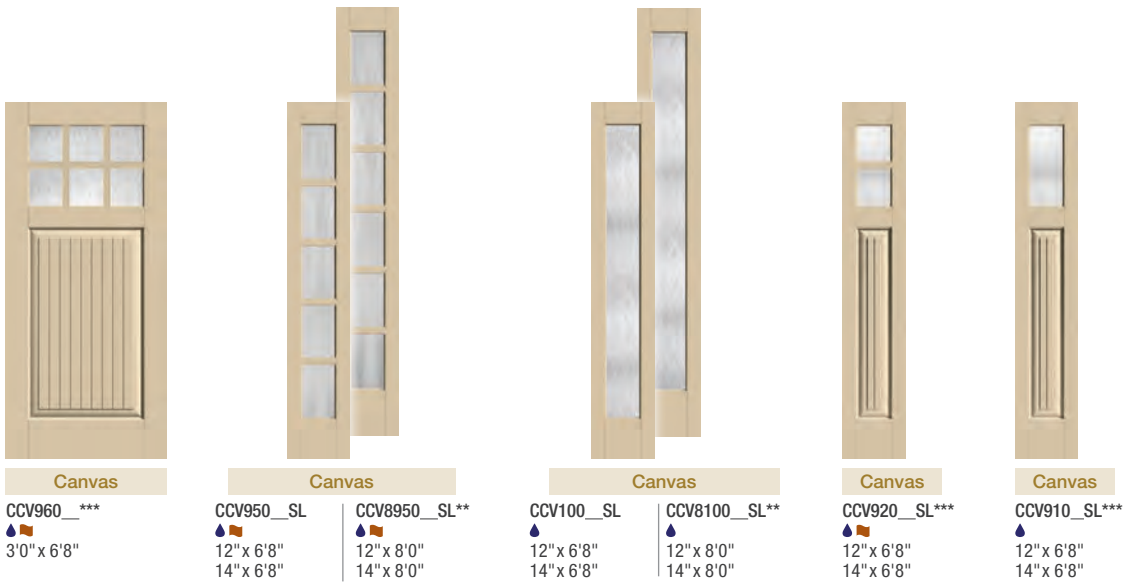

LOW-E



continued

Fir Grain





Formerly Classic-Craft
American Style

Mahogany Grain

Formerly Classic-Craft
Mahogany & Rustic

Canvas

Key

-  Flush-Glazed Glass with Detailed Sticking (FG)
-  Flush-Glazed Glass with Square Sticking (FG)
-  Low-E Glass (LE)
-  Black Nickel Caming (1D)
-  Brushed Nickel Caming (1C)
-  Simulated Divided Lites (SDL)

Optional Dentil Shelves

Available for all Classic Craft Craftsman Lite doors.



16-Block Dentil Shelf



4-Block Dentil Shelf



4-Block Dentil Shelf

Pairs with 3'6" wide doors.



4-Block Dentil Shelf

LOW-E



Fir*

CCA210
 
3'0" x 6'8"

CCA8210
 
3'0" x 8'0"



Fir*

CCA87100
 
3'6" x 8'0"



Fir*

CCA3450SL
  
12" x 6'8"
14" x 6'8"

CCA3560SL
  
12" x 8'0"
14" x 8'0"



Fir*

CCA3400SL
 
12" x 6'8"
14" x 6'8"

CCA3500SL
 
12" x 8'0"
14" x 8'0"



Fir*

CCA220SL
  
12" x 6'8"
14" x 6'8"



Fir*

CCA210SL
 
12" x 6'8"
14" x 6'8"



Canvas

CCV920
  
3'0" x 6'8"



Canvas

CCV930
  
3'0" x 6'8"



Canvas

CCV940
  
3'0" x 6'8"



Canvas

CCV960
  
3'0" x 6'8"



Canvas

CCV910
  
3'0" x 6'8"

*Formerly Classic-Craft American Style.

Note: See page 299 for important product details that may help with your purchase decision.

Right Page: Classic Craft Mahogany Grain, Longford Glass, Door – CCM803, Finish – New Earth

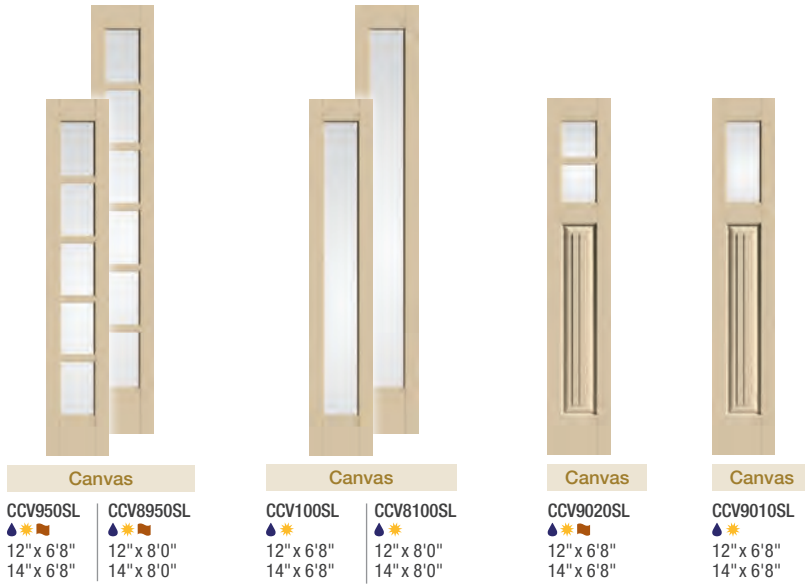

Canvas
 CCV950SL 12" x 6'8"
 14" x 6'8"
 CCV8950SL 12" x 8'0"
 14" x 8'0"

Canvas
 CCV100SL 12" x 6'8"
 14" x 6'8"
 CCV8100SL 12" x 8'0"
 14" x 8'0"

Canvas
 CCV9020SL 12" x 6'8"
 14" x 6'8"

Canvas
 CCV9010SL 12" x 6'8"
 14" x 6'8"

Center Lites

Founders Collection

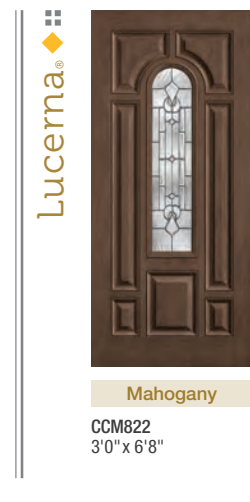
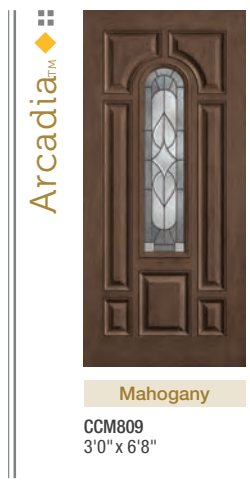









Fir Grain*

Fir Grain

Formerly Classic-Craft
American Style

Key

-  Flush-Glazed Glass with Square Sticking (FG)
-  Black Nickel Caming (1D)
-  Brushed Nickel Caming (1C)
-  Door Divider Bars (DDBF3)
-  Door Divider Bars (DDBF4)
-  Door Divider Bars (DDBF5)
-  WBDR Options
-  Elevated 10" Bottom Rail Options



Artissa

CCA1125
 
3'0" x 6'8"

CCA81125
  
3'0" x 8'0"



Artissa

CCA1149
 
3'0" x 6'8"

CCA81149
  
3'0" x 8'0"



Artissa

CCA1127
 
3'0" x 6'8"

CCA81127
  
3'0" x 8'0"



Artissa

CCA4905
 
3'0" x 6'8"

CCA84905
  
3'0" x 8'0"

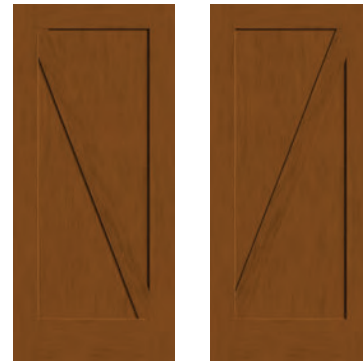

Artissa

CCA4915L
 
3'0" x 6'8"

CCA4915R
 
3'0" x 6'8"

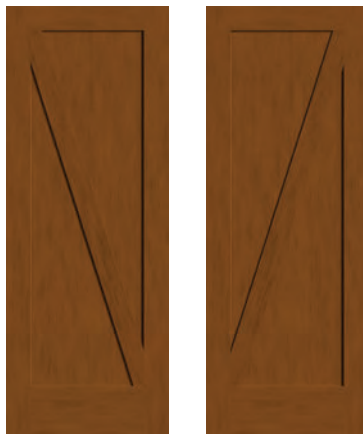

Artissa

CCA84915L
  
3'0" x 8'0"

CCA84915R
  
3'0" x 8'0"



Artissa

CCA4925L
 
3'0" x 6'8"

CCA4925R
 
3'0" x 6'8"

*Formerly Classic-Craft American Style.

Note: See page 299 for important product details that may help with your purchase decision.

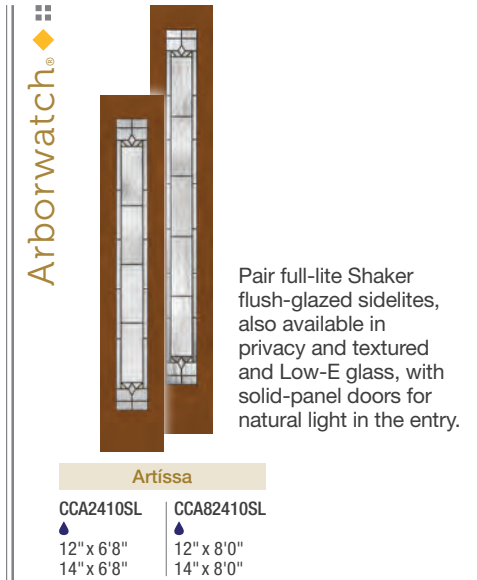
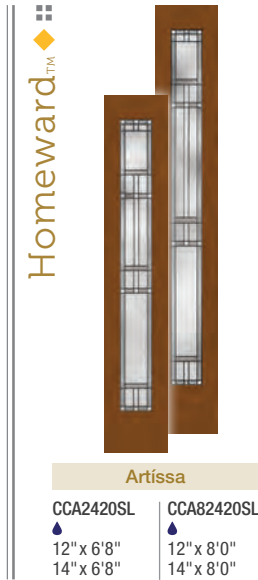

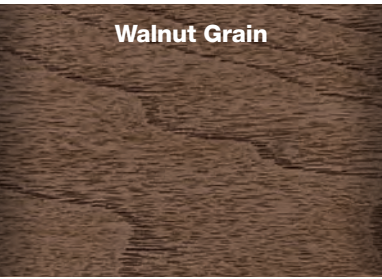

Walnut Grain





Walnut Grain

Key

-  Low-E Glass (LE)
-  WBDR Options
-  Elevated 10" Bottom Rail Options





Visionary

CCW1000 	CCW81000 
2'6" x 6'8" (7'0")	2'6" x 8'0"
2'8" x 6'8" (7'0")	2'8" x 8'0"
2'10" x 6'8" (7'0")	2'10" x 8'0"
3'0" x 6'8" (7'0")	3'0" x 8'0"
3'6" x 6'8" (7'0")	3'6" x 8'0"





Visionary

CCW900L 	CCW8900L 
2'6" x 6'8" (7'0")	2'6" x 8'0"
2'8" x 6'8" (7'0")	2'8" x 8'0"
2'10" x 6'8" (7'0")	2'10" x 8'0"
3'0" x 6'8" (7'0")	3'0" x 8'0"
3'6" x 6'8" (7'0")	3'6" x 8'0"





Visionary

CCW900R 	CCW8900R 
2'6" x 6'8" (7'0")	2'6" x 8'0"
2'8" x 6'8" (7'0")	2'8" x 8'0"
2'10" x 6'8" (7'0")	2'10" x 8'0"
3'0" x 6'8" (7'0")	3'0" x 8'0"
3'6" x 6'8" (7'0")	3'6" x 8'0"





Visionary

CCW901L 	CCW8901L 
2'6" x 6'8" (7'0")	2'6" x 8'0"
2'8" x 6'8" (7'0")	2'8" x 8'0"
2'10" x 6'8" (7'0")	2'10" x 8'0"
3'0" x 6'8" (7'0")	3'0" x 8'0"
3'6" x 6'8" (7'0")	3'6" x 8'0"



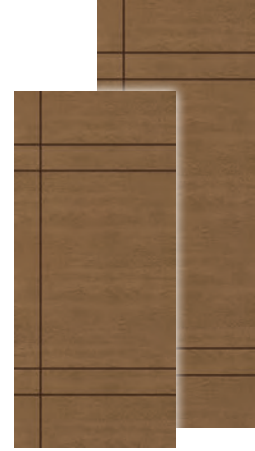

Visionary

CCW901R 	CCW8901R 
2'6" x 6'8" (7'0")	2'6" x 8'0"
2'8" x 6'8" (7'0")	2'8" x 8'0"
2'10" x 6'8" (7'0")	2'10" x 8'0"
3'0" x 6'8" (7'0")	3'0" x 8'0"
3'6" x 6'8" (7'0")	3'6" x 8'0"



Visionary

CCW902L 	CCW8902L 
2'6" x 6'8" (7'0")	2'6" x 8'0"
2'8" x 6'8" (7'0")	2'8" x 8'0"
2'10" x 6'8" (7'0")	2'10" x 8'0"
3'0" x 6'8" (7'0")	3'0" x 8'0"
3'6" x 6'8" (7'0")	3'6" x 8'0"



Note: See page 299 for important product details that may help with your purchase decision.
 Bottom: Classic Craft Walnut Grain Door – CCW902R; Low-E Glass Direct Set Sidelites – DRS82131SL,
 Transoms – 19200T, 19210T, Finish – Shale
 Right Page: Classic Craft Walnut Grain Door – CCW903, Finish – Ashburn



Visionary

CCW902R 6	CCW8902R 6
2'6" x 6'8" (7'0")	2'6" x 8'0"
2'8" x 6'8" (7'0")	2'8" x 8'0"
2'10" x 6'8" (7'0")	2'10" x 8'0"
3'0" x 6'8" (7'0")	3'0" x 8'0"
3'6" x 6'8" (7'0")	3'6" x 8'0"



Visionary

CCW903 6	CCW8903 6
2'6" x 6'8" (7'0")	2'6" x 8'0"
2'8" x 6'8" (7'0")	2'8" x 8'0"
2'10" x 6'8" (7'0")	2'10" x 8'0"
3'0" x 6'8" (7'0")	3'0" x 8'0"
3'6" x 6'8" (7'0")	3'6" x 8'0"

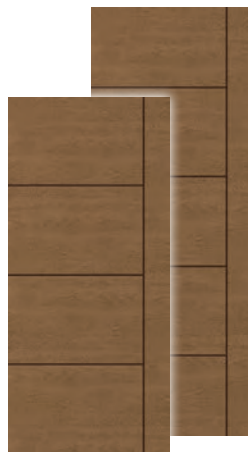

Visionary

CCW904L 6	CCW8904L 6
2'6" x 6'8" (7'0")	2'6" x 8'0"
2'8" x 6'8" (7'0")	2'8" x 8'0"
2'10" x 6'8" (7'0")	2'10" x 8'0"
3'0" x 6'8" (7'0")	3'0" x 8'0"
3'6" x 6'8" (7'0")	3'6" x 8'0"

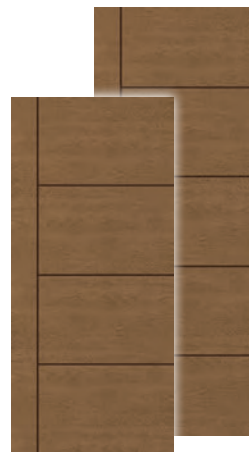

Visionary

CCW904R 6	CCW8904R 6
2'6" x 6'8" (7'0")	2'6" x 8'0"
2'8" x 6'8" (7'0")	2'8" x 8'0"
2'10" x 6'8" (7'0")	2'10" x 8'0"
3'0" x 6'8" (7'0")	3'0" x 8'0"
3'6" x 6'8" (7'0")	3'6" x 8'0"



Visionary

CCW905 6 E	CCW8905 6 E
2'6" x 6'8" (7'0")	2'6" x 8'0"
2'8" x 6'8" (7'0")	2'8" x 8'0"
2'10" x 6'8" (7'0")	2'10" x 8'0"
3'0" x 6'8" (7'0")	3'0" x 8'0"
3'6" x 6'8" (7'0")	3'6" x 8'0"

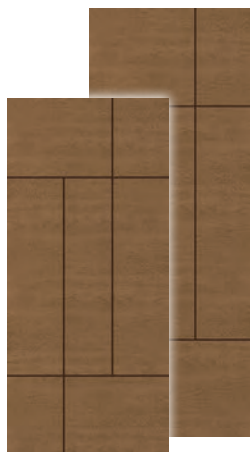

Visionary

CCW906L 6	CCW8906L 6
2'6" x 6'8" (7'0")	2'6" x 8'0"
2'8" x 6'8" (7'0")	2'8" x 8'0"
2'10" x 6'8" (7'0")	2'10" x 8'0"
3'0" x 6'8" (7'0")	3'0" x 8'0"
3'6" x 6'8" (7'0")	3'6" x 8'0"

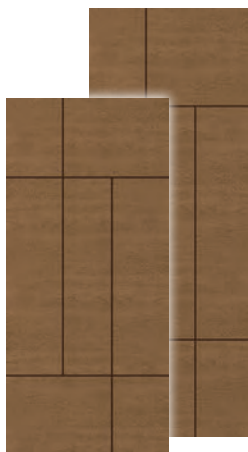

Visionary

CCW906R 6	CCW8906R 6
2'6" x 6'8" (7'0")	2'6" x 8'0"
2'8" x 6'8" (7'0")	2'8" x 8'0"
2'10" x 6'8" (7'0")	2'10" x 8'0"
3'0" x 6'8" (7'0")	3'0" x 8'0"
3'6" x 6'8" (7'0")	3'6" x 8'0"

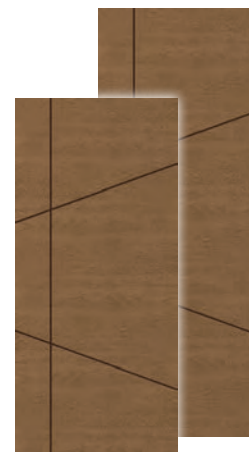

Visionary

CCW907L 6	CCW8907L 6
2'6" x 6'8" (7'0")	2'6" x 8'0"
2'8" x 6'8" (7'0")	2'8" x 8'0"
2'10" x 6'8" (7'0")	2'10" x 8'0"
3'0" x 6'8" (7'0")	3'0" x 8'0"
3'6" x 6'8" (7'0")	3'6" x 8'0"



Visionary

CCW907R 6	CCW8907R 6
2'6" x 6'8" (7'0")	2'6" x 8'0"
2'8" x 6'8" (7'0")	2'8" x 8'0"
2'10" x 6'8" (7'0")	2'10" x 8'0"
3'0" x 6'8" (7'0")	3'0" x 8'0"
3'6" x 6'8" (7'0")	3'6" x 8'0"



LOW-E

Direct Set

DRS2131SL *	DRS82131SL *
12" x 6'8" (7'0")	12" x 8'0"
14" x 6'8" (7'0")	14" x 8'0"

Solid Panels

Mahogany Grain*



Mahogany Grain

Formerly Classic-Craft
Mahogany & Rustic



Oak Grain



Artissa

CCR100 3'0" x 6'8"
3'6" x 6'8" | CCR8100 3'0" x 8'0"
3'6" x 8'0"



Artissa

CCM890
3'0" x 8'0"



Artissa

CCR8222
3'0" x 8'0"
3'6" x 8'0"

Key

- Flush-Glazed Glass with Square Sticking (FG)
- Simulated Divided Lites (SDLF6)
- WBDR Options
- WBDR / HVHZ Options

Optional Accessories

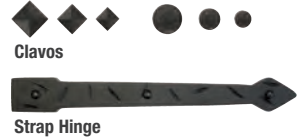

Founders

CCR100R 3'0" x 6'8"
3'6" x 6'8" | CCR8100R 3'0" x 8'0"
3'6" x 8'0"



Founders

CCR040R 3'0" x 6'8"
CCR8040R 3'0" x 8'0"
3'6" x 8'0"



Founders

CCR8225R
3'0" x 8'0"
3'6" x 8'0"



Founders

CCR8005A
3'0" x 8'0"



Founders

CCR205A 3'0" x 6'8"
CCR8205A 3'0" x 8'0"
3'6" x 8'0"



Founders

CCR200A 3'0" x 6'8"
CCR8200A 3'0" x 8'0"

*Formerly Classic-Craft Mahogany and Rustic.

Note: See page 299 for important product details that may help with your purchase decision.



Founders

CCR8225
3'0" x 8'0"
3'6" x 8'0"



Founders

CCR8005
3'0" x 8'0"



Founders

CCR040 | CCR8040
3'0" x 6'8" | 3'0" x 8'0"
3'6" x 8'0"



Founders

CCR205 | CCR8205
3'0" x 6'8" | 3'0" x 8'0"
3'6" x 8'0"



Founders

CCR200 | CCR8200
3'0" x 6'8" | 3'0" x 8'0"



Founders

CCM60
3'0" x 6'8"



Founders

CCM801
3'0" x 6'8"



Founders

CCM701
3'0" x 6'8"

Hammered



Mahogany

CCR2025XHSL | CCR82035XHSL
12" x 6'8" | 12" x 8'0"
14" x 6'8" | 14" x 8'0"

Oak Grain



Artissa

CC91
3'0" x 6'8"



Founders

CC831
3'0" x 8'0"



Founders

CC60 | CC860
2'8" x 6'8" | 3'6" x 8'0"
3'0" x 6'8"



Founders



CC40
3'6" x 6'8"

Solid Panels

Canvas

Canvas

Key

-  Flush-Glazed Glass with Square Sticking (FG)
-  Simulated Divided Lites (SDLF6)
-  WBDH / HVHZ Options

Optional Accessories



Clavos



Strap Hinge



Artissa

CCV200
 3'0" x 6'8"



Founders

CCV205 | CCV8205
 3'0" x 6'8" |  3'0" x 8'0"



Founders

CCV220 | CCV8220
 3'0" x 6'8" |  3'0" x 8'0"

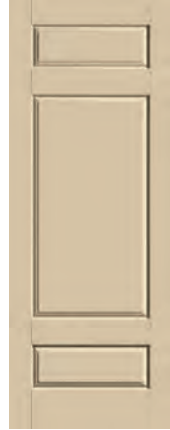

Founders

CCV831
 3'0" x 8'0"



Founders

CCV060
 3'0" x 6'8"







Founders

CCV050
 3'0" x 6'8"

Hammered



Canvas

CCV950XHSL | CCV8950XHSL
 12" x 6'8" |  12" x 8'0"
 14" x 6'8" |  14" x 8'0"



Transoms

Transoms can be stained or painted to match Classic Craft door systems.

Homeward™ ◆◆



HWRT
3'0" door + (2) 12" sidelites
3'0" door + (2) 14" sidelites
Continuous Sill Systems Only



HW30T
3'0" Door Only

Arborwatch® ◆◆



ABRT
3'0" door + (2) 12" sidelites
3'0" door + (2) 14" sidelites
Continuous Sill Systems Only



AB30T
3'0" Door Only

Arcadia™ ◆◆◆



CC060T
3'0" door + (2) 12" sidelites
3'0" door + (2) 14" sidelites
Continuous Sill Systems Only



CC620T
3'0" door + (2) 12" sidelites
3'0" door + (2) 14" sidelites
Continuous Sill Systems Only



CC600T
3'0" Door Only

Longford™ ◆◆



LFET
3'0" door + (2) 12" sidelites
3'0" door + (2) 14" sidelites
Continuous Sill Systems Only



LFRT
3'0" door + (2) 12" sidelites
3'0" door + (2) 14" sidelites
Continuous Sill Systems Only



LF30T
3'0" Door Only

Provincial™ ◆◆◆



CC040T
3'0" door + (2) 12" sidelites
3'0" door + (2) 14" sidelites
Continuous Sill Systems Only



CC420T
3'0" door + (2) 12" sidelites
3'0" door + (2) 14" sidelites
Continuous Sill Systems Only



CC400T
3'0" Door Only

Lucerna® ◆◆



LCET
3'0" door + (2) 12" sidelites
3'0" door + (2) 14" sidelites
Continuous Sill Systems Only



LCRT
3'0" door + (2) 12" sidelites
3'0" door + (2) 14" sidelites
Continuous Sill Systems Only



LC30T
3'0" Door Only

Cambridge™ ◆◆◆



CC090T
3'0" door + (2) 12" sidelites
3'0" door + (2) 14" sidelites
Continuous Sill Systems Only



CC920T
3'0" door + (2) 12" sidelites
3'0" door + (2) 14" sidelites
Continuous Sill Systems Only



CC900T
3'0" Door Only

Zaha® ◆◆



ZHRT
3'0" door + (2) 12" sidelites
3'0" door + (2) 14" sidelites
Continuous Sill Systems Only

Note: See page 299 for important product details that may help with your purchase decision.

Right Page: Classic Craft Canvas, Homeward Glass, Door – CCV9925, Sidelites – CCV911SL, Transom – HWRT

Low-E



Grille Sticks Applied



19020T

☀️
 3'0" door + (2) 12" sidelites
 Continuous Sill Systems Only
 3'0" door + (2) 14" sidelites
 Continuous / Boxed Sill Systems



Grille Sticks Applied



19220T

☀️
 3'0" door + (2) 12" sidelites
 3'0" door + (2) 14" sidelites
 Continuous / Boxed Sill Systems



Grille Sticks Applied



19200T

☀️
 3'0" Door Only



19210T

☀️
 12" & 14"
 Sidelite Only

Key

- ☀️ Low-E Glass (LE)
- ◆ Black Nickel Caming (1D)
- Brushed Nickel Caming (1C)
- ◆ Brass Caming (1A)



Classic Craft® Hinged Patio Doors



A premium entrance to outdoor living.

The unmatched craftsmanship of Classic Craft premium entryways extends to the patio as an uncompromising entrance to the outdoors. Select from remarkably authentic wood grains and premium smooth surfaces to create a seamless indoor-outdoor connection.

Note: Finish colors may vary from an actual application due to fluctuations in finishing or printing. See your Therma-Tru seller or visit www.thermatru.com for details on limited warranties and exclusions, and ENERGY STAR qualified products.

Top: Classic Craft Mahogany Grain, Low-E Glass, Doors – CCM82800, Sidelitess – CCR8000SL, Finish – Lynx

Grain & Texture Options

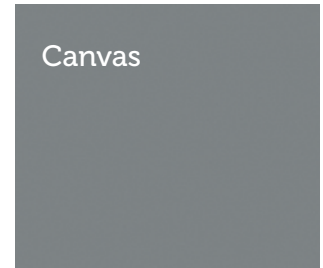
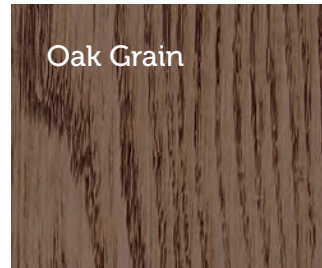

Glass Options



Low-E Glass



Flush-Glazed Glass

Glass built directly into the door during the manufacturing process offers a seamless appearance, wider daylight opening and high-performance weather seal.

EnLiten™ Flush-Glazed Warranty Riders

See page 33 for details on the EnLiten™ Flush-Glazed Rider for Construction & Installation, and the EnLiten™ Flush-Glazed Rider for Homeowners.

Available Configurations

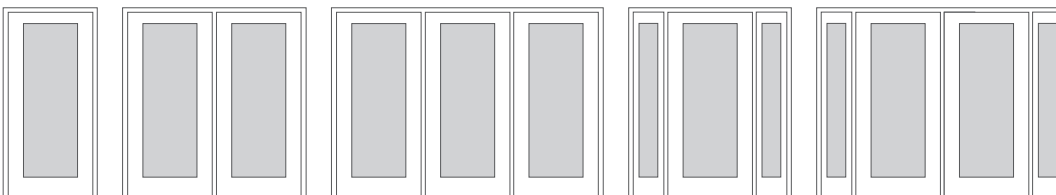

■ = Available		Classic Craft.
Door Selections		
Material		Fiberglass
Warranty		1x Transferable Lifetime
Finish Options		Stain or Paint
Flush-Glazed Glass Selections		
Low-E Glass with and without Divided Lites 🔥	■	
Privacy & Textured Glass with and without Divided Lites 🔥	■	
Lip-Lite Glass Selections		
Low-E Glass with and without Divided Lites	■	
Privacy & Textured Glass with and without Divided Lites	■	
Available Sizes		
Heights		6'8", 8'0"
Single Widths		3'0"
Double Widths		6'0"
Triple Widths		9'0"
Retrofit Openings		
Additional Options		
Screens & Screen Accessories Available Colors: Bronze, White		2" Frame, 3" Frame
Impact-Rated Options		
Tru-Defense Eligible	■	



EnLiten™ Flush-Glazed Low-E Glass



Available Collections

- Classic Craft® Fir Grain
- Classic Craft® Mahogany Grain

Available Door Styles



Available Configurations

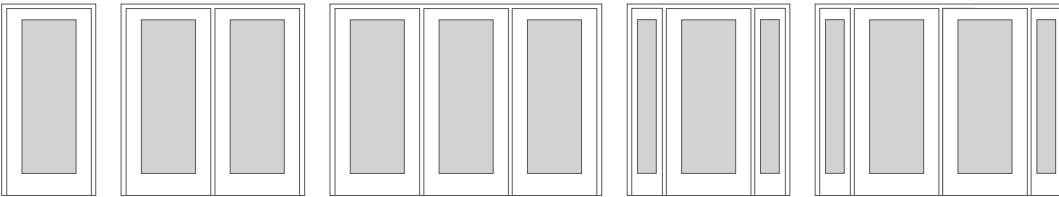

EnLiten™ Flush-Glazed Low-E Glass with Divided Lites



Available Collections

- Classic Craft® Mahogany Grain

Available Door Styles



Available Configurations

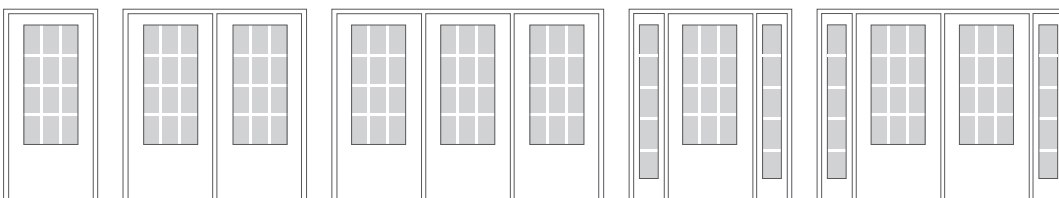

Note: See page 299 for important product details that may help with your purchase decision.

Right Page: Classic Craft Fir Grain, Low-E Glass, Doors – CCA82400, Finish – Acorn, Retractable Screens – White

Low-E Glass



Available Collections

- Classic Craft. Mahogany Grain
- Classic Craft. Oak Grain
- Classic Craft. Canvas

Available Door Styles



Available Configurations

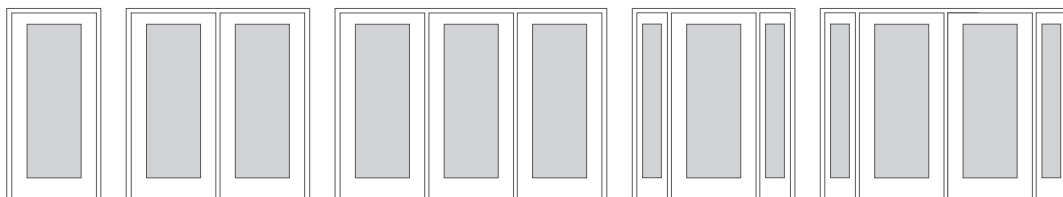

Fiber-Classic® & Smooth-Star® Fiberglass Doors

Fiber-Classic® & Smooth-Star®



Great style for any home.

With many door styles in common and glass families that cross over between door collections, Fiber-Classic and Smooth-Star offers flexible options to fit virtually every entrance from front entry to patio to utility doors at an excellent value.

Top: Smooth-Star, Maple Park Glass, Doors – S86107

Bottom: Fiber-Classic Oak Collection, Internal Blinds, Door – FC678, Finish – Barley

Right Page: Fiber-Classic Mahogany Collection, Low-E Glass with SDLs, Door – FCM4813, Sidelites – FCM2000SL, Transom – 19220T, Finish – Mulberry





Fiber-Classic® Mahogany Collection™

Fiber-Classic Mahogany complements rich wood tones in home interiors, extending the look to the outside with beauty and elegance.



Fiber-Classic® Oak Collection™

Fiber-Classic Oak is the door that started the fiberglass revolution and features the warm look and feel of natural Oak graining.



Smooth-Star®

Smooth-Star fiberglass doors are ready-to-paint with crisp, clean contours making them the more attractive and durable alternative to steel.

See the difference color can make.

Therma-Tru offers a wide variety of finish options for our doors. Explore PrismaGuard® premium finish and Same-Day®. Stain color options on pages 274–278.

Glass Options

- Explore a portfolio of interchangeable decorative glass designs, and privacy and textured glass options starting on page 134.
- Invite light into the home for a more brilliant interior with 22" wide glass in a Lip-lite frame, as well as flush-glazed options with 25–27" wide glass – starting on page 152.
- Lite frames are heat and fade resistant, and suitable for use with a storm door.
- Low-E glass is available for internal blinds, divided lites and clear glass, providing exceptional energy efficiency.



Door Construction

Fiber-Classic® and Smooth-Star® doors set the standard for beauty, quality and performance at an excellent value. Explore the craftsmanship and innovation of doors designed for long-lasting energy efficiency, durability and security.



1 Weather Resistance

Composite rails protect the door at the top and bottom edges to help block moisture that can wick into doors.

2 Security

An enhanced lock block combined with a 1- $\frac{1}{4}$ " engineered lumber lock stile increases rigidity and stability.

3 Durability

With very little maintenance, a fiberglass door can bring a home years of durability. Unlike wood, fiberglass will not warp or rot. And, unlike steel, it will not dent or rust.

4 R-Values

Built with a polyurethane foam core that offers up to four times the insulating R-Value of wood*, Thermo-Tru fiberglass doors insulate against cold and heat for exceptional energy efficiency.



ENERGY STAR® Qualified
Options Available

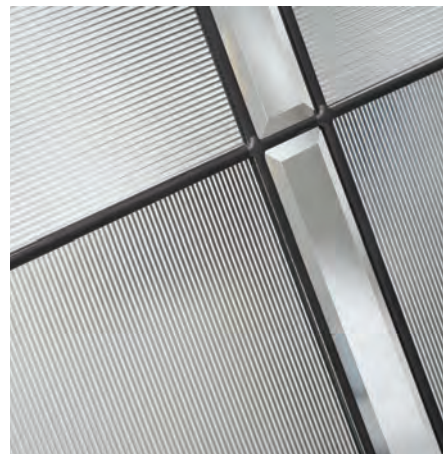

*Comparison of fiberglass to wood doors (both without glass).



Vented Sidelites

More than a sidelite. Vented sidelites from Therma-Tru let the homeowner enjoy the added curb appeal of an elegant front entry unobstructed by a screen door. Choose from convenient specialty glass options or eye-catching decorative designs. In fact, only Therma-Tru offers vented sidelites with decorative glass. Look for the (●) icon.

- Sturdy stiles and hinges make the unit work as a small swinging door.
- Wide patio mullions provide dependable operation.
- Multi-point lock and continuous system help provide security and stability.
- Convenient removable screens – available in bronze and white – are designed for worry-free use.

Available Sizes:

Height	Width	
	12"	14"
6'6"	■	■
6'8"	■	■
8'0"		■



Available Configurations:



Single Door with Vented Sidelites (Inswing Only)



Double Doors with Vented Sidelites (Inswing Only)

Note: No Impact-rated options available for vented sidelites.

Top: Smooth-Star, Granite Glass with SDLs, Door – S2103XN, Sidelites – S2000XNSL

	Fiber-Classic® Mahogany Collection™	Fiber-Classic® Oak Collection™	Smooth-Star®
■ = Available			
● = Not Applicable			
S = Stain			
P = Paint			
Door Widths			
2'0"	■	■	■
2'4"	■	■	■
2'6"	■	■	■
2'8"	■	■	■
2'10"	■	■	■
3'0"	■	■	■
3'6"	●	●	■
Door Heights			
6'6"	●	■	■
6'8"	■	■	■
7'0"	■	■	■
8'0"	■	■	■
Glass Options			
Decorative	15	15	15
Privacy & Textured	7	7	7
Internal Blinds	■	■	■
Flush-Glazed	■	■	■
Screen Vented	●	●	■
Simulated Divided Lites	■	■	■
Grilles Between Glass	■	■	■
Low-E	■	■	■
Clear	■	■	■
Additional Options			
Finish	S / P	S / P	P
Vented Sidelites	■	■	■

Retrofit Hinged Patio Doors

Replacing common slider sizes? Find hinged patio door options in this section. For more about our patio door systems, see pages 222–227.





5'0" Patio Opening = (2) 2'4" Doors
 6'0" Patio Opening = (2) 2'10" Doors

*Please verify that there is a Therma-Tru Impact-rated product approval for the configuration before buying.

Note: Finish colors may vary from an actual application due to fluctuations in finishing or printing. See your Therma-Tru seller or visit www.thermatru.com for more, including details on limited warranties and exclusions, Riders, ENERGY STAR qualified products and product approvals.

Right: Smooth-Star, Clear Glass, Door – S8140



Additional Options

-  WBDR Options: Look for this icon to find door styles that can be configured for WBDR.*
-  WBDR / HVHZ Options: Look for this icon to find door styles that can be configured for WBDR or HVHZ.*
-  Fire-Rated Options: Available on solid-panel doors. See pages 254–259.
-  Flush-Glazed Options: Look for these icons and / or a **blue highlight** to find door styles with flush-glazed glass.

Warranties



Fiber-Classic® and Smooth-Star® products are backed by a lifetime limited warranty. See page 299 for more information.

-  Fiber-Classic® and Smooth-Star® products with flush-glazed glass are also backed by the EnLiten™ Flush-Glazed Rider for Construction & Installation, and the EnLiten™ Flush-Glazed Rider for Homeowners. See page 33 for more information.
-  Fiber-Classic® and Smooth-Star® door systems are eligible for the Tru-Defense® Warranty Rider when properly assembled and installed with all Therma-Tru specified system components, in accordance with the Rider. See page 26–27 for details.



Decorative & Specialty Glass Designs

Blackstone®

Traditional English design meets **1** clear curved bevels, **2** rainglass and coming to create the distinctive styling of Blackstone. Entries get the best of both privacy and simple refinement.

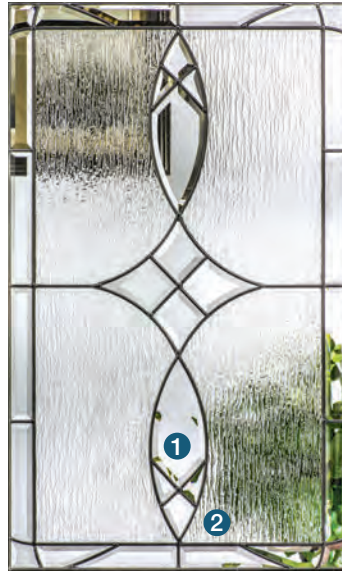

Black Nickel



Brushed Nickel

Crystalline™

This time-honored design features geometric styling brought to life with **1** glue chip glass, **2** glue chip bevels, **3** clear bevels and coming. Offering modest privacy, Crystalline is a shining example of traditional decorative glass with lasting beauty.



Black Nickel



Brushed Nickel

Sedona

Art meets glass in Sedona where Arts and Crafts simplicity is designed with **1** slump glass, **2** clear bevels, **3** clear antique glass and coming.



Black Nickel



Brushed Nickel

Note: Glass privacy ratings may be more or less than indicated, based on glass design and size of glass. Glass designs may differ from depiction due to size and hand craftsmanship of glass. See your Therma-Tru seller or visit www.thermatru.com for details on glass privacy ratings and designs.

Salinas®

1 Oceana glass and wrought iron come together to create a cheerful entry glass design that offers the ultimate in privacy with yesterday's charm.

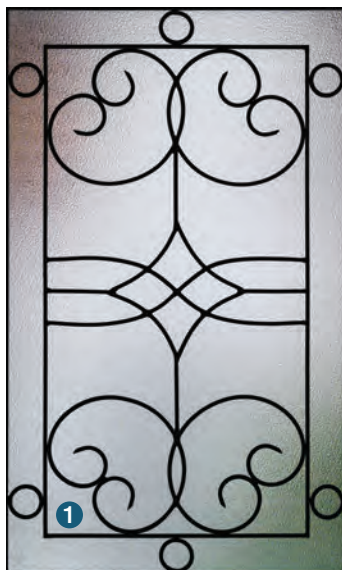

Wrought Iron

Maple Park®

With hints of Mission style and the American Southwest, Maple Park provides a sophisticated appearance with 1 waterglass, 2 clear bevels, 3 granite glass and coming. The curved design adds unique appeal.



Black Nickel



Brushed Nickel

Avonlea®

The dainty leaf design seemingly grows upward in this elegant glass design. Light pours through Avonlea's 1 clear baroque glass and 2 bronze waterglass surrounded by black nickel coming.



Black Nickel

Saratoga™

Saratoga evokes a certain urban sophistication while offering modest privacy with its **1** clear bevels, **2** diamond glass, **3** reeded glass and coming. The geometric pattern bridges both modern and traditional designs.

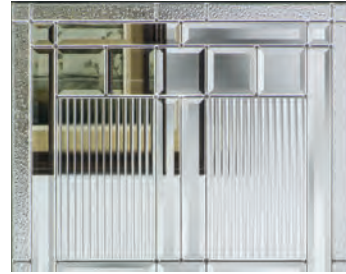

Texas Star

Beautifully crafted with **1** clear bevels, **2** curved bevels, **3** clear waterglass, **4** granite glass, **5** glue chip glass, there's no mistaking the inspiration for this recognizable design. Strong, independent and all-American.



Wellesley™

Simple yet charming, Wellesley's Victorian-inspired design uses **1** clear baroque glass, **2** clear curved bevels, **3** waterglass, **4** granite glass and coming to add beauty to any entry.

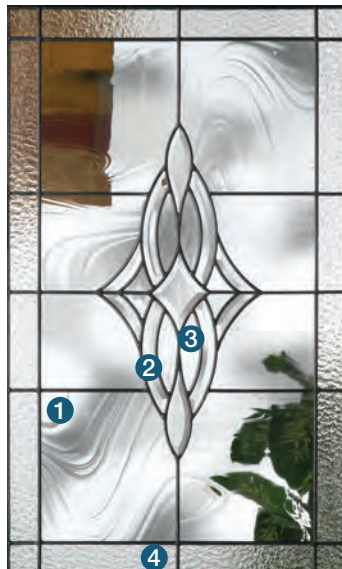

Note: Glass privacy ratings may be more or less than indicated, based on glass design and size of glass. Glass designs may differ from depiction due to size and hand craftsmanship of glass. See your Therma-Tru seller or visit www.thermatru.com for details on glass privacy ratings and designs.

Riserva®

Riserva decorative glass features a combination of linear and curved wrought iron elements that create a simple yet graceful design. Riserva features **1** oceana glass for privacy with a look that enhances a wide variety of home styles, including Mediterranean, Old World and Southwest.



Wrought Iron

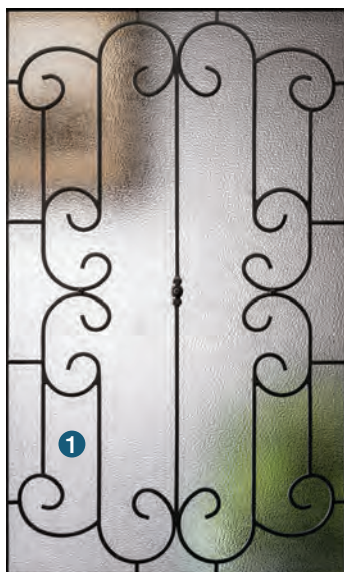

Concorde™

There's just something friendly about Concorde's cheery four-leaf design. **1** Glue chip glass, **2** clear curved bevels, **3** clear glass and coming make up its Old World charm.

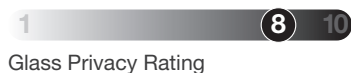

Black Nickel



Brushed Nickel



Brass

Kensington™

Kensington speaks European elegance while offering modest privacy with its **1** clear bevels, **2** glue chip glass, **3** granite glass and coming.

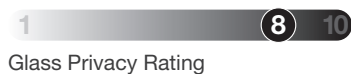

Black Nickel



Brushed Nickel

Pembridge™

Simplistic in its design, Pembridge features a field of **1** hammered glass framed by **2** gray baroque glass and **3** multifaceted bevels. A central diamond shape adds a decorative touch.



Glass Privacy Rating

Note: The use of gray baroque glass varies based on glass size.

Black Nickel

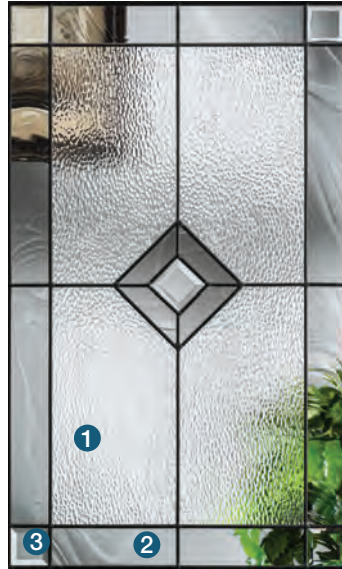

Brushed Nickel



Brass*

Axis®

Simple and smart, Axis combines **1** narrow reeded glass in horizontal and vertical arrangements to create contrast and modest privacy. A vertical band of **2** clear glass bevels completes this linear design, ideal for Modern home styles.



Glass Privacy Rating

Black Nickel



Frosted Images®

Delicate and ornate, Frosted Images offers a high privacy rating with an elegant aesthetic achieved with the simplicity of **1** white-frosted glass.



Glass Privacy Rating



*Brass coming not available for Impact-rated products.

Note: Glass privacy ratings may be more or less than indicated, based on glass design and size of glass. Glass designs may differ from depiction due to size and hand craftsmanship of glass. See your Therma-Tru seller or visit www.thermatru.com for details on glass privacy ratings and designs.

Internal Blinds

Internal blinds provide the privacy and convenience of a cordless blind enclosed between glass. A single-hand operator opens, closes and tilts the blinds to control the desired level of privacy and light.

- 1 Single-Hand Operator
- 2 Privacy Bar

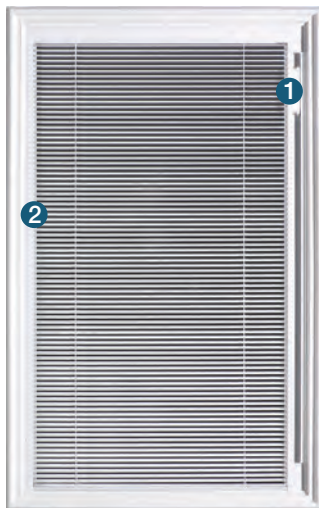

Screen Vented

Screen vented lites offer a built-in screen for ventilation, featuring a gliding operation and sash locking system.



Privacy & Textured Glass



Reeded

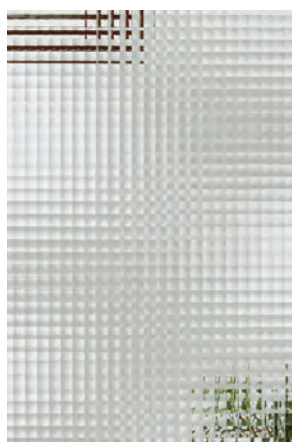

Geometric



Satin Etch

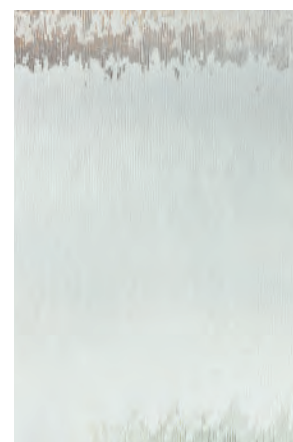

Chord



Chinchilla



Rainglass



Granite



Also Available:
Low-E & Clear Glass

Divided Lites

Simulated Divided Lites (SDLs) with Grilles Between Glass (GBGs)

Choose wood-grained or smooth-textured SDL bars layered over flat bronze GBG bars to achieve the most authentic divided lite look.

Look for the (  ) icons.

Shown with flat bronze GBGs, recommended.

Simulated Divided Lites (SDLs)

Wood-grained or smooth SDL bars are adhered to the interior and exterior panes of tempered glass. Can be stained or painted any color to complement the door and home.

Look for the ( ) icons.



*Available in Special Quote Program.
Note: See page 299 for important product details that may help with your purchase decision.
Bottom: Smooth-Star, Clear Glass with SDLs, Door – S82103, Sidelites – S8000SL

Grilles Between Glass (GBGs)

Contour or flat GBG bars are thermally sealed between two panes of tempered glass for the convenience of a smooth, easy-to-clean glass surface.

Look for the (  ) icons.



Fixed Grilles

Fixed grilles are molded as part of the lite frame on the interior and exterior panes of tempered glass. Can be stained or painted to complement the home décor.

Look for the () icon.



SDL Bar Options

Grained

Smooth

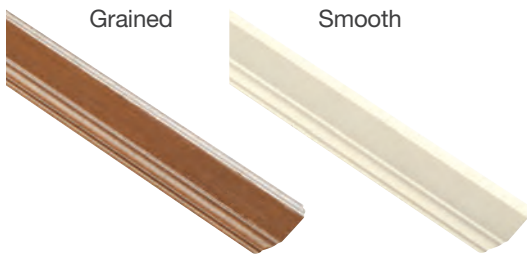

(28.6 mm / 1.125 in.)
Look for the () icon.

Grained

Smooth

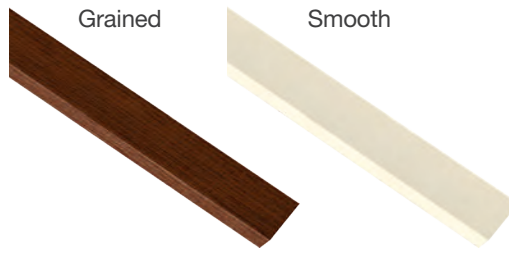

(28.6 mm / 1.125 in.)
Look for the () icon.

Grained

Smooth

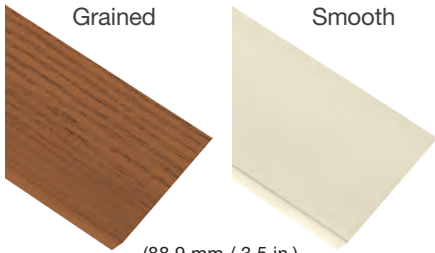

(88.9 mm / 3.5 in.)
Look for the () icon.

GBG Bar Options

Flat

Contour

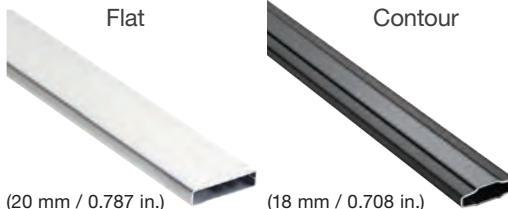



(20 mm / 0.787 in.)

(18 mm / 0.708 in.)

GBG Color Options



Key

-  Simulated Divided Lites (SDL)
-  Simulated Divided Lites (SDLF1)
-  Simulated Divided Lites (SDLF2)
-  Flat or Contour White Grilles Between Glass (GBGF / GBGC)
-  Flat or Contour Almond Grilles Between Glass (GBGF / GBGC)
-  Flat or Contour Bronze Grilles Between Glass (GBGF / GBGC)
-  Flat or Contour Black Grilles Between Glass (GBGF / GBGC)
-  Fixed Grilles (FXG)

Clavos & Strap Hinges

Add a finishing touch of rustic flavor with decorative hardware.

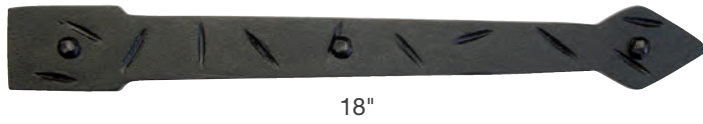

Dentil Shelves

Complete the look with a dentil shelf for true Craftsman appeal.



Fiber-Classic. 4-Block Dentil Shelf*



Smooth-Star. 4-Block Dentil Shelf*



*Not recommended for use behind storm doors or to be painted dark colors, if exposed to direct sunlight.

Bottom: Fiber-Classic Mahogany Collection, Clear Glass with SDLs, Door – FCM4816, Dentil Shelf, Finish – Acorn
 Right Page: Fiber-Classic Oak Collection, Riserva Glass, Door – FC574, Sidelites – FC573SL, Finish – Wildflower Honey



Transoms

For transoms, see page 221.



Blackstone ♦ ❖







Mahogany		Mahogany		Mahogany	Mahogany		Oak		Oak		
FCM108 6 2'8" x 6'8" 2'10" x 6'8" 3'0" x 6'8"	FCM871 6 2'8" x 8'0" 2'10" x 8'0" 3'0" x 8'0"	FCM310 6 2'6" x 6'8" (7'0") 2'8" x 6'8" (7'0") 2'10" x 6'8" (7'0") 3'0" x 6'8" (7'0")	FCM816 6 2'6" x 8'0" 2'8" x 8'0" 2'10" x 8'0" 3'0" x 8'0"	FCM871SL 6 12" x 8'0" 14" x 8'0"	FCM808SL 6 10" x 6'8" 12" x 6'8" (7'0") 14" x 6'8" (7'0")	FCM81918SL 6 12" x 8'0" 14" x 8'0"	FC108 6 2'6" x 6'8" 2'8" x 6'8" (7'0") 2'10" x 6'8" (7'0") 3'0" x 6'8" (7'0")	81918P 6 2'8" x 8'0" 2'10" x 8'0" 3'0" x 8'0"	FC310 6 2'6" x 6'8" Δ (7'0") 2'8" x 6'8" Δ (7'0") 2'10" x 6'8" Δ (7'0") 3'0" x 6'8" Δ (7'0")	FC816 6 2'6" x 8'0" 2'8" x 8'0" 2'10" x 8'0" 3'0" x 8'0"	
Oak		Oak		Smooth		Smooth		Smooth		Smooth	
FC108SL 6 10" x 6'8" 12" x 6'8" 14" x 6'8"	81918PSL 6 12" x 8'0" 14" x 8'0"	FC808SL 6 12" x 6'8" Δ (7'0") 14" x 6'8" Δ (7'0")	81918SL 6 12" x 8'0" 14" x 8'0"	S6002 6 2'6" x 6'8" 2'8" x 6'8" (7'0") 2'10" x 6'8" (7'0") 3'0" x 6'8" (7'0")	S85892 6 2'6" x 8'0" 2'8" x 8'0" 2'10" x 8'0" 3'0" x 8'0"	S310 6 2'6" x 6'8" Δ 2'8" x 6'8" Δ (7'0") 2'10" x 6'8" Δ (7'0") 3'0" x 6'8" Δ (7'0") 3'6" x 6'8"	S816 6 2'6" x 8'0" 2'8" x 8'0" 2'10" x 8'0" 3'0" x 8'0" 3'6" x 8'0"	S6002SL 6 12" x 6'8" 14" x 6'8"	S85892SL 6 12" x 8'0" 14" x 8'0"	S4570SL 6 10" x 6'8" 12" x 6'8" Δ (7'0") 14" x 6'8" Δ (7'0")	S85927SL 6 12" x 8'0" 14" x 8'0"







Key

- No Stile Lines
- ◆ Black Nickel Caming (1D)
- ❖ Brushed Nickel Caming (1C)
- NEW Scrolled & Flat Advanta Lite Frame
- Flat Lite Frame
- Vented Sidelite Options
- 6 WBDR Options
- 6 WBDR / HVHZ Options
- E Elevated 10" Bottom Rail Options
- Δ 6'6" Height Available







Crystalline

Fiber-Classic® & Smooth-Star®

										
Mahogany		Mahogany		Mahogany	Mahogany		Oak		Oak	
FCM16 6	FCM8114 6	FCM668 6E	FCM814 6	FCM8114SL 6	FCM18101SL 6	FCM81800SL 6	FC16 6E	81800P 6	FC668 6E	FC814 6
2'8" x 6'8" 2'10" x 6'8" 3'0" x 6'8"	2'8" x 8'0" 2'10" x 8'0" 3'0" x 8'0"	2'8" x 6'8" (7'0") 2'10" x 6'8" (7'0") 3'0" x 6'8" (7'0")	2'8" x 8'0" 2'10" x 8'0" 3'0" x 8'0"	12" x 8'0" 14" x 8'0"	10" x 6'8" 12" x 6'8" (7'0") 14" x 6'8" (7'0")	12" x 8'0" 14" x 8'0"	2'8" x 6'8" (7'0") 2'10" x 6'8" (7'0") 3'0" x 6'8" (7'0")	2'8" x 8'0" 2'10" x 8'0" 3'0" x 8'0"	2'8" x 6'8" Δ (7'0") 2'10" x 6'8" Δ (7'0") 3'0" x 6'8" Δ (7'0")	2'8" x 8'0" 2'10" x 8'0" 3'0" x 8'0"

											
Oak		Oak		Smooth		Smooth		Smooth		Smooth	
FC46SL 6	81800PSL 6	18101SL 6	81800SL 6	S916 6E	S814 6	S668 6E	S815 6	S916SL 6	S814SL 6	S6130SL 6	S84586SL 6
10" x 6'8" 12" x 6'8" 14" x 6'8"	12" x 8'0" 14" x 8'0"	12" x 6'8" Δ (7'0") 14" x 6'8" Δ (7'0")	12" x 8'0" 14" x 8'0"	2'8" x 6'8" (7'0") 2'10" x 6'8" (7'0") 3'0" x 6'8" (7'0")	2'8" x 8'0" 2'10" x 8'0"	2'8" x 6'8" Δ (7'0") 2'10" x 6'8" Δ (7'0") 3'0" x 6'8" Δ (7'0") 3'6" x 6'8"	2'8" x 8'0" 2'10" x 8'0" 3'0" x 8'0" 3'6" x 8'0"	12" x 6'8" 14" x 6'8"	12" x 8'0" 14" x 8'0"	12" x 6'8" Δ (7'0") 14" x 6'8" Δ (7'0")	12" x 8'0" 14" x 8'0"

Sedona

										
Mahogany		Mahogany		Mahogany	Mahogany		Oak		Oak	
FCM100 E	FCM872 E	FCM241 E	FCM822 E	FCM872SL E	FCM816SL E	FCM81968SL E	FC100 E	81968P E	FC241 E	FC822 E
2'8" x 6'8" 2'10" x 6'8" 3'0" x 6'8"	2'8" x 8'0" 2'10" x 8'0" 3'0" x 8'0"	2'6" x 6'8" (7'0") 2'8" x 6'8" (7'0") 2'10" x 6'8" (7'0") 3'0" x 6'8" (7'0")	2'8" x 8'0" 2'10" x 8'0" 3'0" x 8'0"	12" x 8'0" 14" x 8'0"	10" x 6'8" 12" x 6'8" (7'0") 14" x 6'8" (7'0")	12" x 8'0" 14" x 8'0"	2'6" x 6'8" 2'8" x 6'8" (7'0") 2'10" x 6'8" (7'0") 3'0" x 6'8" (7'0")	2'8" x 8'0" 2'10" x 8'0" 3'0" x 8'0"	2'6" x 6'8" Δ (7'0") 2'8" x 6'8" Δ (7'0") 2'10" x 6'8" Δ (7'0") 3'0" x 6'8" Δ (7'0")	2'8" x 8'0" 2'10" x 8'0" 3'0" x 8'0"

Oak	Oak	Oak	Oak	Smooth	Smooth	Smooth	Smooth
FC100SL 10" x 6'8" 12" x 6'8" 14" x 6'8"	81968PSL 12" x 8'0" 14" x 8'0"	FC816SL 12" x 6'8" (7'0") 14" x 6'8" (7'0")	81968SL 12" x 8'0" 14" x 8'0"	S139 2'6" x 6'8" 2'8" x 6'8" (7'0") 2'10" x 6'8" (7'0") 3'0" x 6'8" (7'0")	S241 2'6" x 6'8" Δ 2'8" x 6'8" Δ (7'0") 2'10" x 6'8" Δ (7'0") 3'0" x 6'8" Δ (7'0") 3'6" x 6'8"	S139SL 12" x 6'8" 14" x 6'8"	S604SL 10" x 6'8" 12" x 6'8" Δ (7'0") 14" x 6'8" Δ (7'0")

Salinas x

Mahogany	Mahogany	Mahogany	Mahogany	Mahogany	Mahogany	Mahogany	Oak	Oak	Oak	Oak
FCM113 2'8" x 6'8" 2'10" x 6'8" 3'0" x 6'8"	FCM873 2'8" x 8'0" 2'10" x 8'0" 3'0" x 8'0"	FCM369 2'6" x 6'8" (7'0") 2'8" x 6'8" (7'0") 2'10" x 6'8" (7'0") 3'0" x 6'8" (7'0")	FCM817 2'6" x 8'0" 2'8" x 8'0" 2'10" x 8'0" 3'0" x 8'0"	FCM814SL 10" x 6'8" 12" x 6'8" (7'0") 14" x 6'8" (7'0")	FCM81919SL 12" x 8'0" 14" x 8'0"	FCM873SL 12" x 8'0" 14" x 8'0"	FC113 2'6" x 6'8" 2'8" x 6'8" (7'0") 2'10" x 6'8" (7'0") 3'0" x 6'8" (7'0")	81919P 2'8" x 8'0" 2'10" x 8'0" 3'0" x 8'0"	FC369 2'6" x 6'8" Δ (7'0") 2'8" x 6'8" Δ (7'0") 2'10" x 6'8" Δ (7'0") 3'0" x 6'8" Δ (7'0")	FC817 2'6" x 8'0" 2'8" x 8'0" 2'10" x 8'0" 3'0" x 8'0"

Oak	Oak	Oak	Oak	Smooth	Smooth	Smooth	Smooth	Smooth	Smooth	Smooth	Smooth
FC113SL 10" x 6'8" 12" x 6'8" 14" x 6'8"	81919PSL 12" x 8'0" 14" x 8'0"	FC814SL 12" x 6'8" Δ (7'0") 14" x 6'8" Δ (7'0")	81919SL 12" x 8'0" 14" x 8'0"	S6008 2'6" x 6'8" 2'8" x 6'8" (7'0") 2'10" x 6'8" (7'0") 3'0" x 6'8" (7'0")	S85893 2'6" x 8'0" 2'8" x 8'0" 2'10" x 8'0" 3'0" x 8'0"	S369 2'6" x 6'8" Δ 2'8" x 6'8" Δ (7'0") 2'10" x 6'8" Δ (7'0") 3'0" x 6'8" Δ (7'0") 3'6" x 6'8"	S817 2'6" x 8'0" 2'8" x 8'0" 2'10" x 8'0" 3'0" x 8'0" 3'6" x 8'0"	S6008SL 12" x 6'8" 14" x 6'8"	S85893SL 12" x 8'0" 14" x 8'0"	S6134SL 10" x 6'8" 12" x 6'8" Δ (7'0") 14" x 6'8" Δ (7'0")	S85931SL 12" x 8'0" 14" x 8'0"

Key

- No Stile Lines
- ✕ Wrought Iron (1W)
- ⬇ Flat Lite Frame
- ⬇ WBDR / HVHZ Options
- ◆ Black Nickel Caming (1D)
- ⬆ NEW Scrolled & Flat Advanta Lite Frame
- ⬆ Vented Sidelite Options
- ⬆ Elevated 10" Bottom Rail Options
- Brushed Nickel Caming (1C)
- ⬆ WBDR Options
- ⬆ 6'6" Height Available

Maple Park



Mahogany

FCM900

2'8" x 6'8"
2'10" x 6'8"
3'0" x 6'8"



Mahogany

FCM1006

2'8" x 6'8" (7'0")
2'10" x 6'8" (7'0")
3'0" x 6'8" (7'0")



Mahogany

FCM812SL

10" x 6'8"
12" x 6'8" (7'0")
14" x 6'8" (7'0")



Oak

FC900

2'8" x 6'8" (7'0")
2'10" x 6'8" (7'0")
3'0" x 6'8" (7'0")



Oak

FC1006

2'8" x 6'8" Δ (7'0")
2'10" x 6'8" Δ (7'0")
3'0" x 6'8" Δ (7'0")



Oak

FC900SL

10" x 6'8"
12" x 6'8"
14" x 6'8"



Oak

FC812SL

12" x 6'8" Δ (7'0")
14" x 6'8" Δ (7'0")



Smooth

S6100

2'8" x 6'8" (7'0")
2'10" x 6'8" (7'0")
3'0" x 6'8" (7'0")

Avonlea



Smooth

S1006

2'8" x 6'8" Δ (7'0")
2'10" x 6'8" Δ (7'0")
3'0" x 6'8" Δ (7'0")
3'6" x 6'8"



Smooth

S6100SL

12" x 6'8"
14" x 6'8"



Smooth

S6131SL

10" x 6'8"
12" x 6'8" Δ (7'0")
14" x 6'8" Δ (7'0")



Mahogany

FCM758

2'8" x 6'8"
2'10" x 6'8"
3'0" x 6'8"

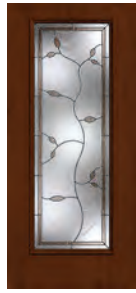

Mahogany

FCM1027

2'8" x 6'8" (7'0")
2'10" x 6'8" (7'0")
3'0" x 6'8" (7'0")



Mahogany

FCM807SL

10" x 6'8"
12" x 6'8" (7'0")
14" x 6'8" (7'0")



Oak

FC758

2'8" x 6'8" (7'0")
2'10" x 6'8" (7'0")
3'0" x 6'8" (7'0")



Oak

FC1027

2'8" x 6'8" Δ (7'0")
2'10" x 6'8" Δ (7'0")
3'0" x 6'8" Δ (7'0")



Oak

FC758SL

10" x 6'8"
12" x 6'8"
14" x 6'8"



Oak

FC807SL

12" x 6'8" (7'0")
14" x 6'8" (7'0")



Smooth

S962

2'8" x 6'8" (7'0")
2'10" x 6'8" (7'0")
3'0" x 6'8" (7'0")



Smooth

S1027

2'8" x 6'8" Δ (7'0")
2'10" x 6'8" Δ (7'0")
3'0" x 6'8" Δ (7'0")
3'6" x 6'8"



Smooth

S962SL







12" x 6'8"
14" x 6'8"









Smooth









S6127SL

10" x 6'8"
12" x 6'8" Δ (7'0")
14" x 6'8" Δ (7'0")

								
Mahogany	Mahogany	Mahogany	Mahogany	Oak	Oak	Oak		
FCM905 6 2'8" x 6'8" 2'10" x 6'8" 3'0" x 6'8"	FCM6093 6E 2'6" x 6'8" (7'0") 2'8" x 6'8" (7'0") 2'10" x 6'8" (7'0") 3'0" x 6'8" (7'0")	FCM815SL 6 10" x 6'8" 12" x 6'8" (7'0") 14" x 6'8" (7'0")	FCM81986SL 6 12" x 8'0" 14" x 8'0"	FCM893SL 6 12" x 8'0" 14" x 8'0"	FC905 6E 2'6" x 6'8" 2'8" x 6'8" (7'0") 2'10" x 6'8" (7'0") 3'0" x 6'8" (7'0")	FC6093 6E 2'6" x 6'8" Δ (7'0") 2'8" x 6'8" Δ (7'0") 2'10" x 6'8" Δ (7'0") 3'0" x 6'8" Δ (7'0")	FC905SL 6 10" x 6'8" 12" x 6'8" 14" x 6'8"	81986PSL 6 12" x 8'0" 14" x 8'0"

								
Oak	Smooth	Smooth	Smooth	Smooth	Mahogany			
FC815SL 6 12" x 6'8" Δ (7'0") 14" x 6'8" Δ (7'0")	81986SL 6 12" x 8'0" 14" x 8'0"	S154 6E 2'6" x 6'8" 2'8" x 6'8" (7'0") 2'10" x 6'8" (7'0") 3'0" x 6'8" (7'0")	S6093 6E 2'6" x 6'8" Δ 2'8" x 6'8" Δ (7'0") 2'10" x 6'8" Δ (7'0") 3'0" x 6'8" Δ (7'0") 3'6" x 6'8"	S154SL 6 12" x 6'8" 14" x 6'8"	S8602SL 6 12" x 8'0" 14" x 8'0"	S602SL 6 10" x 6'8" 12" x 6'8" Δ (7'0") 14" x 6'8" Δ (7'0")	S85932SL 6 12" x 8'0" 14" x 8'0"	FCM142 6 2'8" x 6'8" 2'10" x 6'8" 3'0" x 6'8"

Texas Star

							
Mahogany	Mahogany	Oak	Oak	Oak	Oak	Smooth	Smooth
FCM1029 6E 2'8" x 6'8" (7'0") 2'10" x 6'8" (7'0") 3'0" x 6'8" (7'0")	FCM817SL 6 10" x 6'8" 12" x 6'8" (7'0") 14" x 6'8" (7'0")	FC142 6E 2'8" x 6'8" (7'0") 2'10" x 6'8" (7'0") 3'0" x 6'8" (7'0")	FC1029 6E 2'8" x 6'8" Δ (7'0") 2'10" x 6'8" Δ (7'0") 3'0" x 6'8" Δ (7'0")	FC142SL 6 10" x 6'8" 12" x 6'8" 14" x 6'8"	FC817SL 6 12" x 6'8" Δ (7'0") 14" x 6'8" Δ (7'0")	S6070 6E 2'8" x 6'8" (7'0") 2'10" x 6'8" (7'0") 3'0" x 6'8" (7'0")	S1029 6E 2'8" x 6'8" Δ (7'0") 2'10" x 6'8" Δ (7'0") 3'0" x 6'8" Δ (7'0")







Texas Star Continues on next page.





Key

- No Stile Lines
- ◆ Black Nickel Caming (1D)
- Brushed Nickel Caming (1C)
- └─ Flat Lite Frame
- ▒ NEW Scrolled & Flat Advanta Lite Frame
- Vented Sidelite Options
- 6 WBDR Options
- 6 WBDR / HVHZ Options
- E Elevated 10" Bottom Rail Options
- Δ 6'6" Height Available

Texas Star ◆ ■ ■ Continued

Wellesley™ ◆ ■ ■

					
Smooth	Smooth	Mahogany	Mahogany	Mahogany	Mahogany
S6070SL ■ ■ ■ ■ ■ 12" x 6'8" 14" x 6'8"	S6135SL ■ ■ ■ ■ ■ 10" x 6'8" 12" x 6'8" Δ (7'0") 14" x 6'8" Δ (7'0")	FCM104 ■ ■ ■ ■ ■ 2'8" x 6'8" 2'10" x 6'8" 3'0" x 6'8"	FCM874 ■ ■ ■ ■ ■ 2'8" x 8'0" 2'10" x 8'0" 3'0" x 8'0"	FCM6094 ■ ■ ■ ■ ■ 2'6" x 6'8" (7'0") 2'8" x 6'8" (7'0") 2'10" x 6'8" (7'0") 3'0" x 6'8" (7'0")	FCM821 ■ ■ ■ ■ ■ 2'6" x 8'0" 2'8" x 8'0" 2'10" x 8'0" 3'0" x 8'0"
FCM818SL ■ ■ ■ ■ ■ 10" x 6'8" 12" x 6'8" Δ (7'0") 14" x 6'8" Δ (7'0")	FCM81921SL ■ ■ ■ ■ ■ 12" x 8'0" 14" x 8'0"	FCM874SL ■ ■ ■ ■ ■ 12" x 8'0" 14" x 8'0"			

				
Oak	Oak	Oak	Oak	Smooth
FC104 ■ ■ ■ ■ ■ 2'6" x 6'8" 2'8" x 6'8" (7'0") 2'10" x 6'8" (7'0") 3'0" x 6'8" (7'0")	81921P ■ ■ ■ ■ ■ 2'8" x 8'0" 2'10" x 8'0" 3'0" x 8'0"	FC6094 ■ ■ ■ ■ ■ 2'6" x 6'8" Δ (7'0") 2'8" x 6'8" Δ (7'0") 2'10" x 6'8" Δ (7'0") 3'0" x 6'8" Δ (7'0")	FC821 ■ ■ ■ ■ ■ 2'6" x 8'0" 2'8" x 8'0" 2'10" x 8'0" 3'0" x 8'0"	FC104SL ■ ■ ■ ■ ■ 10" x 6'8" 12" x 6'8" 14" x 6'8"
81921PSL ■ ■ ■ ■ ■ 12" x 8'0" 14" x 8'0"	FC818SL ■ ■ ■ ■ ■ 12" x 6'8" Δ (7'0") 14" x 6'8" Δ (7'0")	81921SL ■ ■ ■ ■ ■ 12" x 8'0" 14" x 8'0"	S155 ■ ■ ■ ■ ■ 2'6" x 6'8" 2'8" x 6'8" (7'0") 2'10" x 6'8" (7'0") 3'0" x 6'8" (7'0")	S85896 ■ ■ ■ ■ ■ 2'6" x 8'0" 2'8" x 8'0" 2'10" x 8'0" 3'0" x 8'0"

Riserva x

				
Smooth	Smooth	Smooth	Mahogany	Mahogany
S6094 ■ ■ ■ ■ ■ 2'6" x 6'8" Δ 2'8" x 6'8" Δ (7'0") 2'10" x 6'8" Δ (7'0") 3'0" x 6'8" Δ (7'0") 3'6" x 6'8"	S821 ■ ■ ■ ■ ■ 2'6" x 8'0" 2'8" x 8'0" 2'10" x 8'0" 3'0" x 8'0" 3'6" x 8'0"	S155SL ■ ■ ■ ■ ■ 12" x 6'8" 14" x 6'8"	S85896SL ■ ■ ■ ■ ■ 12" x 8'0" 14" x 8'0"	S5870SL ■ ■ ■ ■ ■ 10" x 6'8" 12" x 6'8" Δ (7'0") 14" x 6'8" Δ (7'0")
S85934SL ■ ■ ■ ■ ■ 12" x 8'0" 14" x 8'0"	FCM574 ■ ■ ■ ■ ■ 2'8" x 6'8" 2'10" x 6'8" 3'0" x 6'8"	FCM8574 ■ ■ ■ ■ ■ 2'8" x 8'0" 2'10" x 8'0" 3'0" x 8'0"	FCM571 ■ ■ ■ ■ ■ 2'6" x 6'8" (7'0") 2'8" x 6'8" (7'0") 2'10" x 6'8" (7'0") 3'0" x 6'8" (7'0")	FCM8571 ■ ■ ■ ■ ■ 2'6" x 8'0" 2'8" x 8'0" 2'10" x 8'0" 3'0" x 8'0"



Mahogany

FCM572SL
 10" x 6'8"
 12" x 6'8" Δ (7'0")
 14" x 6'8" Δ (7'0")



Mahogany

FCM8572SL
 12" x 8'0"
 14" x 8'0"



Oak

FC574
 2'6" x 6'8"
 2'8" x 6'8" (7'0")
 2'10" x 6'8" (7'0")
 3'0" x 6'8" (7'0")



Oak

FC571
 2'6" x 6'8" Δ (7'0")
 2'8" x 6'8" Δ (7'0")
 2'10" x 6'8" Δ (7'0")
 3'0" x 6'8" Δ (7'0")



Oak

FC573SL
 10" x 6'8"
 12" x 6'8"
 14" x 6'8"



Oak

FC572SL
 12" x 6'8" Δ (7'0")
 14" x 6'8" Δ (7'0")

FC8572SL
 12" x 8'0"
 14" x 8'0"



Smooth

S574
 2'6" x 6'8"
 2'8" x 6'8" (7'0")
 2'10" x 6'8" (7'0")
 3'0" x 6'8" (7'0")



Smooth

S8574
 2'6" x 8'0"
 2'8" x 8'0"
 2'10" x 8'0"
 3'0" x 8'0"



Smooth

S573SL
 12" x 6'8"
 14" x 6'8"



Smooth

S8573SL
 12" x 8'0"
 14" x 8'0"



Mahogany

S572SL
 10" x 6'8"
 12" x 6'8" Δ (7'0")
 14" x 6'8" Δ (7'0")

S8572SL
 12" x 8'0"
 14" x 8'0"



Mahogany

FCM6095
 2'6" x 6'8" (7'0")
 2'8" x 6'8" (7'0")
 2'10" x 6'8" (7'0")
 3'0" x 6'8" (7'0")



Mahogany

FCM820
 2'6" x 8'0"
 2'8" x 8'0"
 2'10" x 8'0"
 3'0" x 8'0"



Mahogany

FCM809SL
 10" x 6'8"
 12" x 6'8" Δ (7'0")
 14" x 6'8" Δ (7'0")



Oak

FCM81928SL
 12" x 8'0"
 14" x 8'0"



Oak



















FC910
 2'6" x 6'8"
 2'8" x 6'8" (7'0")
 2'10" x 6'8" (7'0")
 3'0" x 6'8" (7'0")

81928P
 2'8" x 8'0"
 2'10" x 8'0"
 3'0" x 8'0"

















Concorde Continues on next page.

Key















- No Stile Lines
- Black Nickel Caming (1D)
- Brushed Nickel Caming (1C)
- Brass Caming (1A)
- Wrought Iron (1W)
- Flat Lite Frame
- NEW Scrolled & Flat Advanta Lite Frame
- Vented Sidelite Options
- WBDR Options
- WBDR / HVHZ Options
- Elevated 10" Bottom Rail Options
- 6" Height Available

											
Oak	Oak	Smooth	Smooth	Smooth	Smooth						
FC910SL  10" x 6'8" 12" x 6'8" 14" x 6'8"	81928PSL  12" x 8'0" 14" x 8'0"	FC809SL  12" x 6'8" Δ (7'0") 14" x 6'8" Δ (7'0")	81928SL  12" x 8'0" 14" x 8'0"	S6090  2'6" x 6'8" 2'8" x 6'8" (7'0") 2'10" x 6'8" (7'0") 3'0" x 6'8" (7'0")	S85895  2'6" x 8'0" 2'8" x 8'0" 2'10" x 8'0" 3'0" x 8'0"	S6095  2'6" x 6'8" Δ 2'8" x 6'8" Δ (7'0") 2'10" x 6'8" Δ (7'0") 3'0" x 6'8" Δ (7'0") 3'6" x 6'8"	S820  2'6" x 8'0" 2'8" x 8'0" 3'0" x 8'0"	S416SL  12" x 6'8" 14" x 6'8"	S85895SL  12" x 8'0" 14" x 8'0"	S4070SL  10" x 6'8" 12" x 6'8" Δ (7'0") 14" x 6'8" Δ (7'0")	S85930SL  12" x 8'0" 14" x 8'0"

Kensington™  

							
Mahogany	Mahogany	Mahogany	Oak	Oak	Oak	Oak	Smooth
FCM148  2'8" x 6'8" 2'10" x 6'8" 3'0" x 6'8"	FCM626  2'8" x 6'8" (7'0") 2'10" x 6'8" (7'0") 3'0" x 6'8" (7'0")	FCM813SL  10" x 6'8" 12" x 6'8" Δ (7'0") 14" x 6'8" Δ (7'0")	FC148  2'8" x 6'8" (7'0") 2'10" x 6'8" (7'0") 3'0" x 6'8" (7'0")	FC626  2'8" x 6'8" Δ (7'0") 2'10" x 6'8" Δ (7'0") 3'0" x 6'8" Δ (7'0")	FC148SL  10" x 6'8" 12" x 6'8" 14" x 6'8"	FC813SL  12" x 6'8" Δ (7'0") 14" x 6'8" Δ (7'0")	S160  2'8" x 6'8" (7'0") 2'10" x 6'8" (7'0") 3'0" x 6'8" (7'0")

Pembridge™  

							
Smooth	Smooth	Smooth	Mahogany	Mahogany	Mahogany		
S626  2'8" x 6'8" Δ (7'0") 2'10" x 6'8" Δ (7'0") 3'0" x 6'8" Δ (7'0") 3'6" x 6'8"	S160SL  12" x 6'8" 14" x 6'8"	S6132SL  10" x 6'8" 12" x 6'8" Δ (7'0") 14" x 6'8" Δ (7'0")	FCM6550  2'8" x 6'8" 2'10" x 6'8" 3'0" x 6'8"	FCM86550  2'8" x 8'0" 2'10" x 8'0" 3'0" x 8'0"	FCM6500  2'8" x 6'8" (7'0") 2'10" x 6'8" (7'0") 3'0" x 6'8" (7'0")	FCM86500  2'8" x 8'0" 2'10" x 8'0" 3'0" x 8'0"	FCM86550SL  12" x 8'0" 14" x 8'0"



Mahogany

FCM6500SL

 10" x 6'8"
 12" x 6'8" Δ (7'0")
 14" x 6'8" Δ (7'0")



Oak

FCM86500SL

 12" x 8'0"
 14" x 8'0"

FC6550

 2'8" x 6'8" (7'0")
 2'10" x 6'8" (7'0")
 3'0" x 6'8" (7'0")



Oak

FC86550

 2'8" x 8'0"
 2'10" x 8'0"
 3'0" x 8'0"

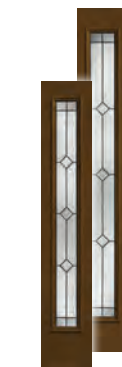

Oak

FC6550SL

 10" x 6'8"
 12" x 6'8"
 14" x 6'8"



Oak

FC86550SL

 12" x 8'0"
 14" x 8'0"

FC6500SL

 12" x 6'8" Δ (7'0")
 14" x 6'8" Δ (7'0")

FC86500SL

 12" x 8'0"
 14" x 8'0"



Smooth

S6550

 2'8" x 6'8" (7'0")
 2'10" x 6'8" (7'0")
 3'0" x 6'8" (7'0")

S86550

 2'8" x 8'0"
 2'10" x 8'0"
 3'0" x 8'0"



Smooth

S6500

 2'8" x 6'8" Δ (7'0")
 2'10" x 6'8" Δ (7'0")
 3'0" x 6'8" Δ (7'0")
 3'6" x 6'8"

S86500

 2'8" x 8'0"
 2'10" x 8'0"
 3'0" x 8'0"
 3'6" x 8'0"



Smooth

S6550SL

 12" x 6'8"
 14" x 6'8"

S86550SL

 12" x 8'0"
 14" x 8'0"



Smooth

S6500SL

 10" x 6'8"
 12" x 6'8" Δ (7'0")
 14" x 6'8" Δ (7'0")

S86500SL

 12" x 8'0"
 14" x 8'0"

Axis



Mahogany

FCM1652

 2'8" x 6'8"
 2'10" x 6'8"
 3'0" x 6'8"

FCM81652

 2'8" x 8'0"
 2'10" x 8'0"
 3'0" x 8'0"



Mahogany

FCM1651

 2'4" x 6'8"
 2'6" x 6'8" (7'0")
 2'8" x 6'8" (7'0")
 2'10" x 6'8" (7'0")
 3'0" x 6'8" (7'0")

FCM81651

 2'6" x 8'0"
 2'8" x 8'0"
 2'10" x 8'0"
 3'0" x 8'0"



Mahogany

FCM1651SL

 10" x 6'8"
 12" x 6'8" Δ (7'0")
 14" x 6'8" Δ (7'0")

FCM81651SL

 12" x 8'0"
 14" x 8'0"



Mahogany

FCM81652SL

 12" x 8'0"
 14" x 8'0"



Oak

FC1652

 2'6" x 6'8"
 2'8" x 6'8" (7'0")
 2'10" x 6'8" (7'0")
 3'0" x 6'8" (7'0")

FC81652

 2'8" x 8'0"
 2'10" x 8'0"
 3'0" x 8'0"



Oak

FC1651

 2'4" x 6'8" Δ
 2'6" x 6'8" Δ (7'0")
 2'8" x 6'8" Δ (7'0")
 2'10" x 6'8" Δ (7'0")
 3'0" x 6'8" Δ (7'0")

FC81651

 2'6" x 8'0"
 2'8" x 8'0"
 2'10" x 8'0"
 3'0" x 8'0"



Oak

FC1652SL

 10" x 6'8"
 12" x 6'8"
 14" x 6'8"

FC81652SL

 12" x 8'0"
 14" x 8'0"

Axis Continues on next page.















Key

- No Stile Lines
- Black Nickel Caming (1D)
- Brushed Nickel Caming (1C)
- Brass Caming (1A)

























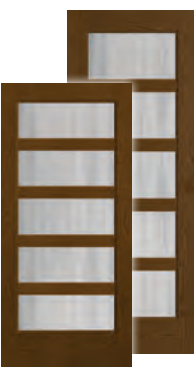
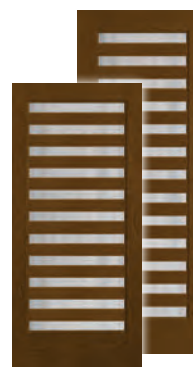
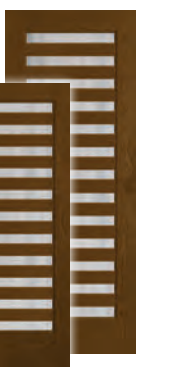





- Flat Lite Frame
- NEW Scrolled & Flat Advanta Lite Frame
- Vented Sidelite Options

- WBDR Options
- WBDR / HVHZ Options
- Elevated 10" Bottom Rail Options

Δ 6'6" Height Available

									
Oak	Smooth	Smooth	Smooth	Smooth					
FC1651SL  12" x 6'8" Δ (7'0") 14" x 6'8" Δ (7'0")	FC81651SL  12" x 8'0" 14" x 8'0"	S1652  2'6" x 6'8" 2'8" x 6'8" (7'0") 2'10" x 6'8" (7'0") 3'0" x 6'8" (7'0")	S81652  2'6" x 8'0" 2'8" x 8'0" 2'10" x 8'0" 3'0" x 8'0"	S1651  2'4" x 6'8" Δ 2'6" x 6'8" Δ 2'8" x 6'8" Δ (7'0") 2'10" x 6'8" Δ (7'0") 3'0" x 6'8" Δ (7'0") 3'6" x 6'8"	S81651  2'6" x 8'0" 2'8" x 8'0" 2'10" x 8'0" 3'0" x 8'0" 3'6" x 8'0"	S1652SL  12" x 6'8" 14" x 6'8"	S81652SL  12" x 8'0" 14" x 8'0"	S1651SL  10" x 6'8" 12" x 6'8" Δ (7'0") 14" x 6'8" Δ (7'0")	S81651SL  12" x 8'0" 14" x 8'0"

EnLiten™ Flush-Glazed Privacy & Textured Glass with Divided Lites

									
Oak	Oak	Oak	Oak	Oak	Oak	Oak			
FC1205_  2'6" x 6'8" 2'8" x 6'8" 3'0" x 6'8"	FC1207_  2'6" x 6'8" 2'8" x 6'8" 3'0" x 6'8"	2010_  2'6" x 6'8" 2'8" x 6'8" 3'0" x 6'8"	2050_  2'6" x 6'8" 2'8" x 6'8" 3'0" x 6'8"	2050_SL  12" x 6'8" 14" x 6'8"	FC5700_  2'6" x 6'8" 2'8" x 6'8" 3'0" x 6'8"	FC85700_  2'6" x 8'0" 2'8" x 8'0" 2'10" x 8'0" 3'0" x 8'0"			
									
Oak	Oak	Oak	Oak	Oak	Oak	Oak	Oak	Oak	Oak
FC5710_  2'6" x 6'8" 2'8" x 6'8" 3'0" x 6'8"	FC85710_  2'6" x 8'0" 2'8" x 8'0" 2'10" x 8'0" 3'0" x 8'0"	FC5720_  2'6" x 6'8" 2'8" x 6'8" 3'0" x 6'8"	FC85720_  2'6" x 8'0" 2'8" x 8'0" 2'10" x 8'0" 3'0" x 8'0"	FC691_  2'6" x 6'8" 2'8" x 6'8" 3'0" x 6'8"	FC8691_  2'6" x 8'0" 2'8" x 8'0" 2'10" x 8'0" 3'0" x 8'0"	FC685L_  2'6" x 6'8" 2'8" x 6'8" 3'0" x 6'8"	FC8685L_  2'6" x 8'0" 2'8" x 8'0" 2'10" x 8'0" 3'0" x 8'0"	FC685R_  2'6" x 6'8" 2'8" x 6'8" 3'0" x 6'8"	FC8685R_  2'6" x 8'0" 2'8" x 8'0" 2'10" x 8'0" 3'0" x 8'0"

Privacy & Textured Glass Options

Add the code to the blank in the style number for the desired door and glass combination. For details on glass options, see page 139.

XK = Reeded	XE = Satin Etch	XJ = Chinchilla	XN = Granite
XG = Geometric	XC = Chord	XR = Rainglass	

*Not available with Reeded (XK) or Geometric (XG) glass.

Note: See page 299 for important product details that may help with your purchase decision.



Oak FC5700_SL ▲ 2 12" x 6'8" 14" x 6'8"	Oak FC5710_SL ▲ 2 12" x 6'8" 14" x 6'8"	Oak FC5720_SL ▲ 2 12" x 6'8" 14" x 6'8"	Smooth S1205 ▲ 2 E 2'6" x 6'8" ▲ 2'8" x 6'8" ▲ 2'10" x 6'8" ▲ 3'0" x 6'8" ▲	Smooth S1207 ▲ 2 E 2'6" x 6'8" ▲ 2'8" x 6'8" ▲ 2'10" x 6'8" ▲ 3'0" x 6'8" ▲	Smooth S2010 ▲ 2 E 2'6" x 6'8" ▲ 2'8" x 6'8" ▲ 2'10" x 6'8" ▲ 3'0" x 6'8" ▲	Smooth S2050 ▲ 2 E 2'6" x 6'8" ▲ 2'8" x 6'8" ▲ 2'10" x 6'8" ▲ 3'0" x 6'8" ▲
--	--	--	--	--	--	--



Smooth S5705 ▲ 2 E 2'6" x 6'8" ▲ 2'8" x 6'8" ▲ 2'10" x 6'8" ▲ 3'0" x 6'8" ▲	Smooth S85705 ▲ 2 E 2'6" x 8'0" 2'8" x 8'0" 2'10" x 8'0" 3'0" x 8'0"	Smooth S5715 ▲ 2 E 2'6" x 6'8" ▲ 2'8" x 6'8" ▲ 2'10" x 6'8" ▲ 3'0" x 6'8" ▲	Smooth S85715 ▲ 2 E 2'6" x 8'0" 2'8" x 8'0" 2'10" x 8'0" 3'0" x 8'0"	Smooth S5725 ▲ 2 E 2'6" x 6'8" ▲ 2'8" x 6'8" ▲ 2'10" x 6'8" ▲ 3'0" x 6'8" ▲	Smooth S85725 ▲ 2 E 2'6" x 8'0" 2'8" x 8'0" 2'10" x 8'0" 3'0" x 8'0"	Smooth S2010_SL ▲ 2 E 10" x 6'8" ▲ 12" x 6'8" ▲ (7'0") 14" x 6'8" ▲ (7'0")	Smooth S84886_SL ▲ 2 E 12" x 8'0" ▲ 14" x 8'0" ▲	Smooth S2000_SL-2C* ▲ 2 E 10" x 6'8" ▲ 12" x 6'8" ▲ 14" x 6'8" ▲
--	---	--	---	--	---	--	---	--



Smooth S2000_SL-4C* ▲ 2 E 10" x 6'8" ▲ 12" x 6'8" ▲ 14" x 6'8" ▲	Smooth S5700 ▲ 2 E 2'6" x 6'8" ▲ 2'8" x 6'8" ▲ 2'10" x 6'8" ▲ 3'0" x 6'8" ▲	Smooth S85700 ▲ 2 E 2'6" x 8'0" 2'8" x 8'0" 2'10" x 8'0" 3'0" x 8'0"	Smooth S5710 ▲ 2 E 2'6" x 6'8" ▲ 2'8" x 6'8" ▲ 2'10" x 6'8" ▲ 3'0" x 6'8" ▲	Smooth S85710 ▲ 2 E 2'6" x 8'0" 2'8" x 8'0" 2'10" x 8'0" 3'0" x 8'0"	Smooth S5720 ▲ 2 E 2'6" x 6'8" ▲ 2'8" x 6'8" ▲ 2'10" x 6'8" ▲ 3'0" x 6'8" ▲	Smooth S85720 ▲ 2 E 2'6" x 8'0" 2'8" x 8'0" 2'10" x 8'0" 3'0" x 8'0"	Smooth S691 ▲ 2 E 2'6" x 6'8" ▲ 2'8" x 6'8" ▲ 2'10" x 6'8" ▲ 3'0" x 6'8" ▲	Smooth S8691 ▲ 2 E 2'6" x 8'0" 2'8" x 8'0" 2'10" x 8'0" 3'0" x 8'0"
--	--	---	--	---	--	---	---	--





EnLiten Flush-Glazed Privacy & Textured Glass with Divided Lites *Continues on next page.*

Key











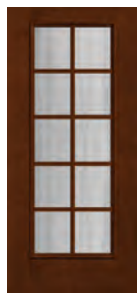



- No Stile Lines
- ▲ Flush-Glazed Glass with Detailed Sticking (FG)
- ◆ Black Nickel Caming (1D)
- Simulated Divided Lites (SDL)
- 1 Simulated Divided Lites (SDLF1)
- 2 Simulated Divided Lites (SDLF2)
- ▲ Flat Lite Frame
- ▲ NEW Scrolled & Flat Advanta Lite Frame
- Vented Sidelite Options
- E Elevated 10" Bottom Rail Options
- 6 WBDR Options
- 6 WBDR / HVHZ Options
- ▲ 6'6" Height Available

EnLiten™ Flush-Glazed Privacy & Textured Glass with Divided Lites *Continued*

Fiber-Classic® & Smooth-Star®

				
Smooth	Smooth	Smooth	Smooth	Smooth
S685L_ ▲ 2 E 2'6" x 6'8" ▲ 2'8" x 6'8" ▲ 2'10" x 6'8" ▲ 3'0" x 6'8" ▲	S8685L_ ▲ 2 E 2'6" x 8'0" ▲ 2'8" x 8'0" ▲ 2'10" x 8'0" ▲ 3'0" x 8'0" ▲	S685R_ ▲ 2 E 2'6" x 6'8" ▲ 2'8" x 6'8" ▲ 2'10" x 6'8" ▲ 3'0" x 6'8" ▲	S8685R_ ▲ 2 E 2'6" x 8'0" ▲ 2'8" x 8'0" ▲ 2'10" x 8'0" ▲ 3'0" x 8'0" ▲	S5700_SL ▲ 2 ● 10" x 6'8" ▲ 12" x 6'8" ▲ 14" x 6'8" ▲
			S85700_SL ▲ 2 12" x 8'0" ▲ 14" x 8'0" ▲	S5710_SL ▲ 2 ● 10" x 6'8" ▲ 12" x 6'8" ▲ 14" x 6'8" ▲
				S85710_SL ▲ 2 12" x 8'0" ▲ 14" x 8'0" ▲
				S5720_SL ▲ 2 ● 10" x 6'8" ▲ 12" x 6'8" ▲ 14" x 6'8" ▲
				S85720_SL ▲ 2 12" x 8'0" ▲ 14" x 8'0" ▲

Privacy & Textured Glass with Divided Lites

						
Mahogany	Mahogany	Mahogany	Mahogany	Mahogany	Mahogany	Mahogany
FCM138_ ▲ ● 2'8" x 6'8" ▲ 2'10" x 6'8" ▲ 3'0" x 6'8" ▲	FCM1285_ ▲ ● E 2'8" x 6'8" (7'0") ▲ 2'10" x 6'8" (7'0") ▲ 3'0" x 6'8" (7'0") ▲	FCM18_ ▲ ● 2'8" x 6'8" ▲ 2'10" x 6'8" ▲ 3'0" x 6'8" ▲	FCM1284_ ▲ ● E 2'8" x 6'8" (7'0") ▲ 2'10" x 6'8" (7'0") ▲ 3'0" x 6'8" (7'0") ▲	FCM12102_SL ▲ ● ● 12" x 6'8" ▲ (7'0") ▲ 14" x 6'8" ▲ (7'0") ▲	FCM6124_SL* ▲ ● ● 10" x 6'8" ▲ 12" x 6'8" ▲ (7'0") ▲ 14" x 6'8" ▲ (7'0") ▲	FCM6125_SL* ▲ ● ● 10" x 6'8" ▲ 12" x 6'8" ▲ (7'0") ▲ 14" x 6'8" ▲ (7'0") ▲
						
Mahogany	Oak	Oak	Oak	Oak	Oak	Oak
FCM6126_SL* ▲ ● ● 10" x 6'8" ▲ 12" x 6'8" ▲ (7'0") ▲ 14" x 6'8" ▲ (7'0") ▲	FC138_ ▲ ● E 2'8" x 6'8" (7'0") ▲ 2'10" x 6'8" (7'0") ▲ 3'0" x 6'8" (7'0") ▲	1285_ ▲ ● ● E 2'8" x 6'8" ▲ (7'0") ▲ 2'10" x 6'8" ▲ (7'0") ▲ 3'0" x 6'8" ▲ (7'0") ▲	FC18_ ▲ ● E 2'8" x 6'8" (7'0") ▲ 2'10" x 6'8" (7'0") ▲ 3'0" x 6'8" (7'0") ▲	1284_ ▲ ● ● E 2'8" x 6'8" ▲ (7'0") ▲ 2'10" x 6'8" ▲ (7'0") ▲ 3'0" x 6'8" ▲ (7'0") ▲	FC18_SL ▲ ● 12" x 6'8" ▲ 14" x 6'8" ▲	12102_SL ▲ ● ● 12" x 6'8" ▲ (7'0") ▲ 14" x 6'8" ▲ (7'0") ▲

Privacy & Textured Glass Options

Add the code to the blank in the style number for the desired floor and glass combination. For details on glass options, see page 139.

XK = Reeded

XG = Geometric

XE = Satin Etch

XC = Chord











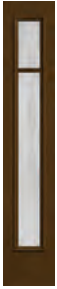

























XJ = Chinchilla





































XR = Rainglass

XN = Granite

































*Not available with Reeded (XK) or Geometric (XG) glass.

Note: See page 299 for important product details that may help with your purchase decision.

							
Oak	Oak	Oak	Oak	Oak	Oak	Smooth	Smooth
FC06188_SL*   10" x 6'8" 12" x 6'8" 14" x 6'8"	FC06184_SL*     12" x 6'8" Δ (7'0") 14" x 6'8" Δ (7'0")	FC06189_SL*   10" x 6'8" 12" x 6'8" 14" x 6'8"	FC06185_SL*     12" x 6'8" Δ (7'0") 14" x 6'8" Δ (7'0")	FC06190_SL*   10" x 6'8" 12" x 6'8" 14" x 6'8"	FC06186_SL*     12" x 6'8" Δ (7'0") 14" x 6'8" Δ (7'0")	S128_       2'8" x 6'8" (7'0") 2'10" x 6'8" (7'0") 3'0" x 6'8" (7'0")	S141_      2'8" x 6'8" Δ (7'0") 2'10" x 6'8" Δ (7'0") 3'0" x 6'8" Δ (7'0") 3'6" x 6'8"

							
Smooth	Smooth	Smooth	Smooth	Smooth	Smooth	Smooth	Smooth
S108_     2'8" x 6'8" (7'0") 2'10" x 6'8" (7'0") 3'0" x 6'8" (7'0")	S6063_       2'8" x 6'8" Δ (7'0") 2'10" x 6'8" Δ (7'0") 3'0" x 6'8" Δ (7'0") 3'6" x 6'8"	S308_SL   12" x 6'8" 14" x 6'8"	S1170_SL    10" x 6'8" 12" x 6'8" Δ (7'0") 14" x 6'8" Δ (7'0")	S605_SL*   12" x 6'8" 14" x 6'8"	S6124_SL*      10" x 6'8" 12" x 6'8" Δ (7'0") 14" x 6'8" Δ (7'0")	S606_SL*    12" x 6'8" 14" x 6'8"	S6125_SL*     10" x 6'8" 12" x 6'8" Δ (7'0") 14" x 6'8" Δ (7'0")

EnLiten™ Flush-Glazed Privacy & Textured Glass

								
Smooth	Smooth	Oak	Oak	Smooth	Smooth			
S607_SL*   12" x 6'8" 14" x 6'8"	S6126_SL*      10" x 6'8" 12" x 6'8" Δ (7'0") 14" x 6'8" Δ (7'0")	2000_   2'6" x 6'8" 2'8" x 6'8" 3'0" x 6'8"	8000_   2'6" x 8'0" 2'8" x 8'0" 2'10" x 8'0" 3'0" x 8'0"	2000_SL  12" x 6'8" 14" x 6'8"	S2000_      2'6" x 6'8" Δ 2'8" x 6'8" Δ 2'10" x 6'8" Δ 3'0" x 6'8" Δ	S8000_     2'6" x 8'0" 2'8" x 8'0" 2'10" x 8'0" 3'0" x 8'0"	S2000_SL    10" x 6'8" Δ 12" x 6'8" Δ (7'0") 14" x 6'8" Δ (7'0")	S8000_SL   12" x 8'0" 14" x 8'0"

Key

-  No Stile Lines
-  Flush-Glazed Glass with Detailed Sticking (FG)
-  Simulated Divided Lites (SDL)
-  Simulated Divided Lites (SDLF2)
-  NEW Scrolled Advanta Lite Frame
-  Vented Sidelite Options
-  Elevated 10" Bottom Rail Options
-  6'6" Height Available

Privacy & Textured Glass



Mahogany

FCM10_	FCM870_
2'8" x 6'8"	2'8" x 8'0"
2'10" x 6'8"	2'10" x 8'0"
3'0" x 6'8"	3'0" x 8'0"



Mahogany

FCM1283_	FCM81200_
2'8" x 6'8" (7'0")	2'6" x 8'0"
2'10" x 6'8" (7'0")	2'10" x 8'0"
3'0" x 6'8" (7'0")	3'0" x 8'0"



Mahogany

FCM870_SL
12" x 8'0"
14" x 8'0"



Mahogany

FCM12101_SL	FCM81200_SL
10" x 6'8"	12" x 8'0"
12" x 6'8" Δ (7'0")	14" x 8'0"
14" x 6'8" Δ (7'0")	



Oak

FC10_	81200P_
2'8" x 6'8" (7'0")	2'8" x 8'0"
2'10" x 6'8" (7'0")	2'10" x 8'0"
3'0" x 6'8" (7'0")	3'0" x 8'0"



Oak

1283	81200_
2'8" x 6'8" Δ (7'0")	2'6" x 8'0"
2'10" x 6'8" Δ (7'0")	2'10" x 8'0"
3'0" x 6'8" Δ (7'0")	3'0" x 8'0"



Oak

FC47_SL	81200P_SL
10" x 6'8"	12" x 8'0"
12" x 6'8"	14" x 8'0"
14" x 6'8"	



Oak

12101_SL	81200_SL
12" x 6'8" Δ (7'0")	12" x 8'0"
14" x 6'8" Δ (7'0")	14" x 8'0"



Smooth

S118_	S818_
2'8" x 6'8" (7'0")	2'8" x 8'0"
2'10" x 6'8" (7'0")	2'10" x 8'0"
3'0" x 6'8" (7'0")	3'0" x 8'0"



Smooth

S140_	S8140_
2'8" x 6'8" Δ (7'0")	2'6" x 8'0"
2'10" x 6'8" Δ (7'0")	2'10" x 8'0"
3'0" x 6'8" Δ (7'0")	3'0" x 8'0"
3'6" x 6'8"	3'6" x 8'0"

EnLiten™ Flush-Glazed Internal Blinds



Smooth

S100_SL	S8601_SL
12" x 6'8"	12" x 8'0"
14" x 6'8"	14" x 8'0"



Smooth

S601_SL	S81086_SL
10" x 6'8"	12" x 8'0"
12" x 6'8" Δ (7'0")	14" x 8'0"
14" x 6'8" Δ (7'0")	



Smooth

S2600	S82600
2'6" x 6'8" Δ	2'6" x 8'0"
2'8" x 6'8" Δ	2'8" x 8'0"
2'10" x 6'8" Δ	2'10" x 8'0"
3'0" x 6'8" Δ	3'0" x 8'0"



Privacy & Textured Glass Options

Add the code to the blank in the style number for the desired door and glass combination. For details on glass options, see page 139.

XK = Reeded

XG = Geometric

XE = Satin Etch

XC = Chord

XJ = Chinchilla

XR = Rainglass

XN = Granite

Internal Blinds



Mahogany

FCM141
 2'8" x 6'8"
 2'10" x 6'8"
 3'0" x 6'8"

FCM8115
 2'8" x 8'0"
 2'10" x 8'0"
 3'0" x 8'0"



Mahogany

FCM1286
 2'4" x 6'8"
 2'6" x 6'8" (7'0")
 2'8" x 6'8" (7'0")
 2'10" x 6'8" (7'0")
 3'0" x 6'8" (7'0")

FCM81225
 2'6" x 8'0"
 2'8" x 8'0"
 2'10" x 8'0"
 3'0" x 8'0"



Mahogany

FCM8115SL
 12" x 8'0"
 14" x 8'0"



Mahogany

FCM1286SL
 10" x 6'8"
 12" x 6'8" Δ (7'0")
 14" x 6'8" Δ (7'0")

FCM81225SL
 12" x 8'0"
 14" x 8'0"



Oak

FC141
 2'6" x 6'8"
 2'8" x 6'8" (7'0")
 2'10" x 6'8" (7'0")
 3'0" x 6'8" (7'0")

81225P
 2'8" x 8'0"
 2'10" x 8'0"
 3'0" x 8'0"



Oak

1286
 2'4" x 6'8" Δ
 2'6" x 6'8" Δ (7'0")
 2'8" x 6'8" Δ (7'0")
 2'10" x 6'8" Δ (7'0")
 3'0" x 6'8" Δ (7'0")

81225
 2'6" x 8'0"
 2'8" x 8'0"
 2'10" x 8'0"
 3'0" x 8'0"



Oak

FC141SL
 10" x 6'8"
 12" x 6'8"
 14" x 6'8"

81225PSL
 12" x 8'0"
 14" x 8'0"



Oak

1286SL
 12" x 6'8" Δ (7'0")
 14" x 6'8" Δ (7'0")

81225SL
 12" x 8'0"
 14" x 8'0"



Smooth

S130
 2'6" x 6'8"
 2'8" x 6'8" (7'0")
 2'10" x 6'8" (7'0")
 3'0" x 6'8" (7'0")

S829
 2'6" x 8'0"
 2'8" x 8'0"
 2'10" x 8'0"
 3'0" x 8'0"



Smooth

S6061
 2'4" x 6'8" Δ
 2'6" x 6'8" Δ
 2'8" x 6'8" Δ (7'0")
 2'10" x 6'8" Δ (7'0")
 3'0" x 6'8" Δ (7'0")
 3'6" x 6'8"

S81225
 2'6" x 8'0"
 2'8" x 8'0"
 2'10" x 8'0"
 3'0" x 8'0"
 3'6" x 8'0"



Smooth

S130SL
 12" x 6'8"
 14" x 6'8"

S829SL
 12" x 8'0"
 14" x 8'0"

S6128SL
 10" x 6'8"
 12" x 6'8" Δ (7'0")
 14" x 6'8" Δ (7'0")

S85928SL
 12" x 8'0"
 14" x 8'0"

EnLiten™ Flush-Glazed Clear Glass with Divided Lites



Mahogany

FCM1205SL
 12" x 6'8"
 14" x 6'8"



Mahogany

FCM1206SL
 12" x 6'8"
 14" x 6'8"



Mahogany

FCM1204SL
 12" x 6'8"
 14" x 6'8"



Mahogany

FCM2009SL
 12" x 6'8"
 14" x 6'8"









Oak







FC1205
 2'6" x 6'8"
 2'8" x 6'8"
 3'0" x 6'8"







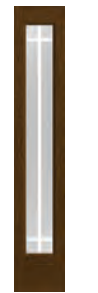

EnLiten Flush-Glazed Clear Glass with Divided Lites *Continues on next page.*

Key

- No Stile Lines
- Low-E Glass (LE)
- Flush-Glazed Glass with Detailed Sticking (FG)
- Flush-Glazed Glass with Square Sticking (FG)
- Simulated Divided Lites (SDL)
- Simulated Divided Lites (SDLFI)
- Flat or Contour White Grilles Between Glass (GBGF / GBGC)
- Flat or Contour Bronze Grilles Between Glass (GBGF / GBGC)
- Flat Lite Frame
- NEW Scrolled & Flat Advanta Lite Frame
- Vented Sidelite Options
- WBDR Options
- WBDR / HVHZ Options
- Elevated 10" Bottom Rail Options
- Δ 6'6" Height Available

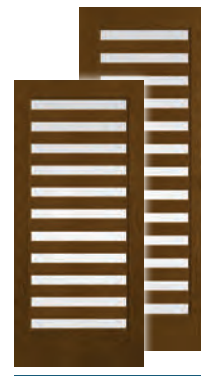
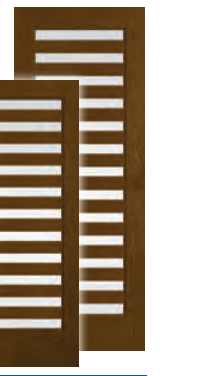
						
Oak	Oak	Oak	Oak	Oak	Oak	Oak
FC1206 ☀️ ⚡️ ⚡️ ⚡️ ⚡️ 2'6" x 6'8" 2'8" x 6'8" 3'0" x 6'8"	FC1207 ☀️ ⚡️ ⚡️ ⚡️ ⚡️ 2'6" x 6'8" 2'8" x 6'8" 3'0" x 6'8"	2010 ☀️ ⚡️ ⚡️ ⚡️ ⚡️ 2'6" x 6'8" 2'8" x 6'8" 3'0" x 6'8"	FC1204 ☀️ ⚡️ ⚡️ ⚡️ ⚡️ 2'6" x 6'8" 2'8" x 6'8" 3'0" x 6'8"	2050 ☀️ ⚡️ ⚡️ ⚡️ ⚡️ 2'6" x 6'8" 2'8" x 6'8" 3'0" x 6'8"	8000-12 ☀️ ⚡️ ⚡️ ⚡️ ⚡️ 2'6" x 8'0" 2'8" x 8'0" 2'10" x 8'0" 3'0" x 8'0"	8000-18 ☀️ ⚡️ ⚡️ ⚡️ ⚡️ 2'6" x 8'0" 2'8" x 8'0" 2'10" x 8'0" 3'0" x 8'0"

							
Oak	Oak	Oak	Oak	Oak	Oak	Oak	Oak
FC1205SL ☀️ ⚡️ ⚡️ ⚡️ ⚡️ 12" x 6'8" 14" x 6'8"	FC1206SL ☀️ ⚡️ ⚡️ ⚡️ ⚡️ 12" x 6'8" 14" x 6'8"	FC1204SL ☀️ ⚡️ ⚡️ ⚡️ ⚡️ 12" x 6'8" 14" x 6'8"	2050SL ☀️ ⚡️ ⚡️ ⚡️ ⚡️ 12" x 6'8" 14" x 6'8"	2009 ☀️ ⚡️ ⚡️ ⚡️ ⚡️ 2'0" x 6'8" 2'6" x 6'8" 2'8" x 6'8" 3'0" x 6'8"	8000-9 ☀️ ⚡️ ⚡️ ⚡️ ⚡️ 2'0" x 8'0" 2'6" x 8'0" 2'8" x 8'0" 2'10" x 8'0" 3'0" x 8'0"	FC5700 ☀️ ⚡️ ⚡️ ⚡️ ⚡️ 2'6" x 6'8" 2'8" x 6'8" 3'0" x 6'8"	FC85700 ☀️ ⚡️ ⚡️ ⚡️ ⚡️ 2'6" x 8'0" 2'8" x 8'0" 2'10" x 8'0" 3'0" x 8'0"

									
Oak	Oak	Oak	Oak	Oak	Oak	Oak	Oak	Oak	Oak
FC5710 ☀️ ⚡️ ⚡️ ⚡️ ⚡️ 2'6" x 6'8" 2'8" x 6'8" 3'0" x 6'8"	FC85710 ☀️ ⚡️ ⚡️ ⚡️ ⚡️ 2'6" x 8'0" 2'8" x 8'0" 2'10" x 8'0" 3'0" x 8'0"	FC5720 ☀️ ⚡️ ⚡️ ⚡️ ⚡️ 2'6" x 6'8" 2'8" x 6'8" 3'0" x 6'8"	FC85720 ☀️ ⚡️ ⚡️ ⚡️ ⚡️ 2'6" x 8'0" 2'8" x 8'0" 2'10" x 8'0" 3'0" x 8'0"	FC691 ☀️ ⚡️ ⚡️ ⚡️ ⚡️ 2'6" x 6'8" 2'8" x 6'8" 3'0" x 6'8"	FC8691 ☀️ ⚡️ ⚡️ ⚡️ ⚡️ 2'6" x 8'0" 2'8" x 8'0" 2'10" x 8'0" 3'0" x 8'0"	FC685L ☀️ ⚡️ ⚡️ ⚡️ ⚡️ 2'6" x 6'8" 2'8" x 6'8" 3'0" x 6'8"	FC8685L ☀️ ⚡️ ⚡️ ⚡️ ⚡️ 2'6" x 8'0" 2'8" x 8'0" 2'10" x 8'0" 3'0" x 8'0"	FC685R ☀️ ⚡️ ⚡️ ⚡️ ⚡️ 2'6" x 6'8" 2'8" x 6'8" 3'0" x 6'8"	FC8685R ☀️ ⚡️ ⚡️ ⚡️ ⚡️ 2'6" x 8'0" 2'8" x 8'0" 2'10" x 8'0" 3'0" x 8'0"



Oak FC5700SL ▲ 🔥 ⚡ 2 12" x 6'8" 14" x 6'8"	Oak FC5710SL ▲ 🔥 ⚡ 2 12" x 6'8" 14" x 6'8"	Oak FC5720SL ▲ 🔥 ⚡ 2 12" x 6'8" 14" x 6'8"	Smooth S1205 ▲ 🔥 ⚡ ⚡ ⚡ ⚡ ⚡ ⚡ E 2'6" x 6'8" ▲ 2'8" x 6'8" ▲ 2'10" x 6'8" ▲ 3'0" x 6'8" ▲	Smooth S1206 ▲ 🔥 ⚡ ⚡ ⚡ ⚡ E 2'6" x 6'8" ▲ 2'8" x 6'8" ▲ 2'10" x 6'8" ▲ 3'0" x 6'8" ▲	Smooth S1207 ▲ 🔥 ⚡ ⚡ ⚡ ⚡ E 2'6" x 6'8" ▲ 2'8" x 6'8" ▲ 2'10" x 6'8" ▲ 3'0" x 6'8" ▲	Smooth S2010 ▲ 🔥 ⚡ ⚡ ⚡ ⚡ E 2'6" x 6'8" ▲ 2'8" x 6'8" ▲ 2'10" x 6'8" ▲ 3'0" x 6'8" ▲
---	---	---	--	--	--	--



Smooth S1204 ▲ 🔥 ⚡ ⚡ ⚡ ⚡ E 2'6" x 6'8" ▲ 2'8" x 6'8" ▲ 2'10" x 6'8" ▲ 3'0" x 6'8" ▲	Smooth S2050 ▲ 🔥 ⚡ ⚡ ⚡ ⚡ E 2'6" x 6'8" ▲ 2'8" x 6'8" ▲ 2'10" x 6'8" ▲ 3'0" x 6'8" ▲	Smooth S8000-12 ▲ 🔥 ⚡ ⚡ ⚡ ⚡ E 2'6" x 8'0" 2'8" x 8'0" 2'10" x 8'0" 3'0" x 8'0"	Smooth S8000-18 ▲ 🔥 ⚡ ⚡ ⚡ ⚡ E 2'6" x 8'0" 2'8" x 8'0" 2'10" x 8'0" 3'0" x 8'0"	Smooth S5705 ▲ 🔥 ⚡ ⚡ E 2'6" x 6'8" ▲ 2'8" x 6'8" ▲ 2'10" x 6'8" ▲ 3'0" x 6'8" ▲	Smooth S85705 ▲ 🔥 ⚡ ⚡ E 2'6" x 8'0" 2'8" x 8'0" 2'10" x 8'0" 3'0" x 8'0"	Smooth S5715 ▲ 🔥 ⚡ ⚡ E 2'6" x 6'8" ▲ 2'8" x 6'8" ▲ 2'10" x 6'8" ▲ 3'0" x 6'8" ▲	Smooth S85715 ▲ 🔥 ⚡ ⚡ E 2'6" x 8'0" 2'8" x 8'0" 2'10" x 8'0" 3'0" x 8'0"
--	--	---	---	--	---	--	---

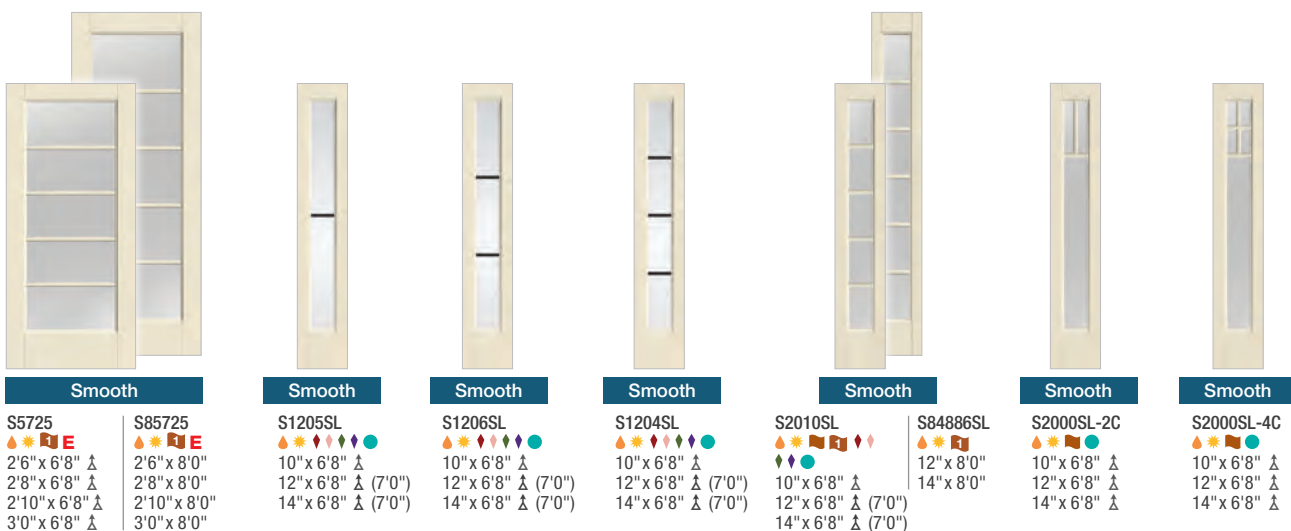

Smooth S5725 ▲ 🔥 ⚡ ⚡ E 2'6" x 6'8" ▲ 2'8" x 6'8" ▲ 2'10" x 6'8" ▲ 3'0" x 6'8" ▲	Smooth S85725 ▲ 🔥 ⚡ ⚡ E 2'6" x 8'0" 2'8" x 8'0" 2'10" x 8'0" 3'0" x 8'0"	Smooth S1205SL ▲ 🔥 ⚡ ⚡ ⚡ ⚡ ● 10" x 6'8" ▲ 12" x 6'8" ▲ (7'0") 14" x 6'8" ▲ (7'0")	Smooth S1206SL ▲ 🔥 ⚡ ⚡ ⚡ ⚡ ● 10" x 6'8" ▲ 12" x 6'8" ▲ (7'0") 14" x 6'8" ▲ (7'0")	Smooth S1204SL ▲ 🔥 ⚡ ⚡ ⚡ ⚡ ● 10" x 6'8" ▲ 12" x 6'8" ▲ (7'0") 14" x 6'8" ▲ (7'0")	Smooth S2010SL ▲ 🔥 ⚡ ⚡ ⚡ ⚡ ⚡ ⚡ 10" x 6'8" ▲ 12" x 6'8" ▲ (7'0") 14" x 6'8" ▲ (7'0")	Smooth S84886SL ▲ 🔥 ⚡ ⚡ 12" x 8'0" 14" x 8'0"	Smooth S2000SL-2C ▲ 🔥 ⚡ ⚡ ● 10" x 6'8" ▲ 12" x 6'8" ▲ 14" x 6'8" ▲	Smooth S2000SL-4C ▲ 🔥 ⚡ ⚡ ● 10" x 6'8" ▲ 12" x 6'8" ▲ 14" x 6'8" ▲
--	---	---	---	---	---	--	--	--

EnLiten Flush-Glazed Clear Glass with Divided Lites *Continues on next page.*

Key

- ▲ Flush-Glazed Glass with Detailed Sticking (FG)
- ⚡ Low-E Glass (LE)
- ⚡ Simulated Divided Lites (SDL)
- ⚡ Simulated Divided Lites (SDLF1)
- 2 Simulated Divided Lites (SDLF2)
- ◆ Flat or Contour White Grilles Between Glass (GBGF / GBGC)
- ◆ Flat or Contour Black Grilles Between Glass (GBGF / GBGC)
- ◆ Flat or Contour Almond Grilles Between Glass (GBGF / GBGC)
- ◆ Flat or Contour Bronze Grilles Between Glass (GBGF / GBGC)
- ◆ Flat or Contour Black Grilles Between Glass (GBGF / GBGC)
- Vented Sidelite Options
- E Elevated 10" Bottom Rail Options
- ▲ 6'6" Height Available



Smooth

S2009

- ▲▲▲▲▲ E
- 2'0" x 6'8" ▲
- 2'6" x 6'8" ▲
- 2'8" x 6'8" ▲
- 2'10" x 6'8" ▲
- 3'0" x 6'8" ▲

S8000-9

- ▲▲▲▲▲ E
- 2'0" x 8'0" ▲
- 2'6" x 8'0" ▲
- 2'8" x 8'0" ▲
- 2'10" x 8'0" ▲
- 3'0" x 8'0" ▲



Smooth

S2009SL

- ▲▲▲▲▲●
- 10" x 6'8" ▲
- 12" x 6'8" ▲ (7'0")
- 14" x 6'8" ▲ (7'0")



Smooth

S5700

- ▲▲▲ E
- 2'6" x 6'8" ▲
- 2'8" x 6'8" ▲
- 2'10" x 6'8" ▲
- 3'0" x 6'8" ▲

S85700

- ▲▲▲ E
- 2'6" x 8'0" ▲
- 2'8" x 8'0" ▲
- 2'10" x 8'0" ▲
- 3'0" x 8'0" ▲



Smooth

S5710

- ▲▲▲ E
- 2'6" x 6'8" ▲
- 2'8" x 6'8" ▲
- 2'10" x 6'8" ▲
- 3'0" x 6'8" ▲

S85710

- ▲▲▲ E
- 2'6" x 8'0" ▲
- 2'8" x 8'0" ▲
- 2'10" x 8'0" ▲
- 3'0" x 8'0" ▲



Smooth

S5720

- ▲▲▲ E
- 2'6" x 6'8" ▲
- 2'8" x 6'8" ▲
- 2'10" x 6'8" ▲
- 3'0" x 6'8" ▲

S85720

- ▲▲▲ E
- 2'6" x 8'0" ▲
- 2'8" x 8'0" ▲
- 2'10" x 8'0" ▲
- 3'0" x 8'0" ▲



Smooth

S691

- ▲▲▲ E
- 2'6" x 6'8" ▲
- 2'8" x 6'8" ▲
- 2'10" x 6'8" ▲
- 3'0" x 6'8" ▲

S8691

- ▲▲▲ E
- 2'6" x 8'0" ▲
- 2'8" x 8'0" ▲
- 2'10" x 8'0" ▲
- 3'0" x 8'0" ▲



Smooth

S685L

- ▲▲▲ E
- 2'6" x 6'8" ▲
- 2'8" x 6'8" ▲
- 2'10" x 6'8" ▲
- 3'0" x 6'8" ▲

S8685L

- ▲▲▲ E
- 2'6" x 8'0" ▲
- 2'8" x 8'0" ▲
- 2'10" x 8'0" ▲
- 3'0" x 8'0" ▲



Smooth

S685R

- ▲▲▲ E
- 2'6" x 6'8" ▲
- 2'8" x 6'8" ▲
- 2'10" x 6'8" ▲
- 3'0" x 6'8" ▲

S8685R

- ▲▲▲ E
- 2'6" x 8'0" ▲
- 2'8" x 8'0" ▲
- 2'10" x 8'0" ▲
- 3'0" x 8'0" ▲



Smooth

S5700SL

- ▲▲▲●
- 10" x 6'8" ▲
- 12" x 6'8" ▲
- 14" x 6'8" ▲

S85700SL

- ▲▲▲●
- 12" x 8'0" ▲
- 14" x 8'0" ▲



Smooth

S5710SL

- ▲▲▲●
- 10" x 6'8" ▲
- 12" x 6'8" ▲
- 14" x 6'8" ▲

S85710SL

- ▲▲▲●
- 12" x 8'0" ▲
- 14" x 8'0" ▲



Smooth

S5720SL

- ▲▲▲●
- 10" x 6'8" ▲
- 12" x 6'8" ▲
- 14" x 6'8" ▲

S85720SL

- ▲▲▲●
- 12" x 8'0" ▲
- 14" x 8'0" ▲



Note: See page 299 for important product details that may help with your purchase decision.

Bottom: Smooth-Star, Clear Glass with SDLs, Doors – S85715, Finish – Alpine







Clear Glass with Divided Lites







							
Mahogany	Mahogany	Mahogany	Mahogany	Mahogany	Mahogany	Mahogany	
FCM1209 ☀️ ⬆️ ⬆️ ⬆️ ⬆️ 2'8" x 6'8" 2'10" x 6'8" 3'0" x 6'8"	FCM1201 ☀️ ⬆️ ⬆️ ⬆️ ⬆️ E 2'6" x 6'8" (7'0") 2'8" x 6'8" (7'0") 2'10" x 6'8" (7'0") 3'0" x 6'8" (7'0")	FCM1211 ☀️ ⬆️ ⬆️ ⬆️ ⬆️ 2'8" x 6'8" 2'10" x 6'8" 3'0" x 6'8"	FCM1202 ☀️ ⬆️ ⬆️ ⬆️ ⬆️ E 2'6" x 6'8" (7'0") 2'8" x 6'8" (7'0") 2'10" x 6'8" (7'0") 3'0" x 6'8" (7'0")	FCM1212 ☀️ ⬆️ ⬆️ ⬆️ ⬆️ 2'8" x 6'8" 2'10" x 6'8" 3'0" x 6'8"	FCM1203 ☀️ ⬆️ ⬆️ ⬆️ ⬆️ E 2'6" x 6'8" (7'0") 2'8" x 6'8" (7'0") 2'10" x 6'8" (7'0") 3'0" x 6'8" (7'0")	FCM138 ☀️ ⬆️ ⬆️ ⬆️ ⬆️ 6 2'8" x 6'8" 2'10" x 6'8" 3'0" x 6'8"	
							
Mahogany	Mahogany	Mahogany	Mahogany	Mahogany	Mahogany	Mahogany	
FCM1285 ☀️ ⬆️ ⬆️ ⬆️ ⬆️ 6 E 2'6" x 6'8" (7'0") 2'8" x 6'8" (7'0") 2'10" x 6'8" (7'0") 3'0" x 6'8" (7'0")	FCM1208 ☀️ ⬆️ ⬆️ ⬆️ ⬆️ 6 2'8" x 6'8" 2'10" x 6'8" 3'0" x 6'8"	FCM1200 ☀️ ⬆️ ⬆️ ⬆️ ⬆️ 6 E 2'6" x 6'8" (7'0") 2'8" x 6'8" (7'0") 2'10" x 6'8" (7'0") 3'0" x 6'8" (7'0")	FCM18 ☀️ ⬆️ ⬆️ ⬆️ ⬆️ 6 2'8" x 6'8" 2'10" x 6'8" 3'0" x 6'8"	FCM1284 ☀️ ⬆️ ⬆️ ⬆️ ⬆️ 6 E 2'6" x 6'8" (7'0") 2'8" x 6'8" (7'0") 2'10" x 6'8" (7'0") 3'0" x 6'8" (7'0")	FCM828 ☀️ ⬆️ ⬆️ ⬆️ ⬆️ 6 2'8" x 8'0" 2'10" x 8'0" 3'0" x 8'0"	FCM81828 ☀️ ⬆️ ⬆️ ⬆️ ⬆️ 6 2'6" x 8'0" 2'8" x 8'0" 2'10" x 8'0" 3'0" x 8'0"	
							
Mahogany	Mahogany	Mahogany	Mahogany	Mahogany	Mahogany	Mahogany	Mahogany
FCM81208P ☀️ ⬆️ ⬆️ ⬆️ ⬆️ 6 2'8" x 8'0" 2'10" x 8'0" 3'0" x 8'0"	FCM81829 ☀️ ⬆️ ⬆️ ⬆️ ⬆️ 6 2'6" x 8'0" 2'8" x 8'0" 2'10" x 8'0" 3'0" x 8'0"	FCM1201SL ☀️ ⬆️ ⬆️ ⬆️ ⬆️ 10" x 6'8" 12" x 6'8" Δ (7'0") 14" x 6'8" Δ (7'0")	FCM1202SL ☀️ ⬆️ ⬆️ ⬆️ ⬆️ 10" x 6'8" 12" x 6'8" Δ (7'0") 14" x 6'8" Δ (7'0")	FCM1200SL ☀️ ⬆️ ⬆️ ⬆️ ⬆️ 6 10" x 6'8" 12" x 6'8" Δ (7'0") 14" x 6'8" Δ (7'0")	FCM12102SL ☀️ ⬆️ ⬆️ ⬆️ ⬆️ 6 10" x 6'8" 12" x 6'8" Δ (7'0") 14" x 6'8" Δ (7'0")	FCM81208PSL ☀️ ⬆️ ⬆️ ⬆️ ⬆️ 6 12" x 8'0" 14" x 8'0"	FCM81208SL ☀️ ⬆️ ⬆️ ⬆️ ⬆️ 6 12" x 8'0" 14" x 8'0"







Clear Glass with Divided Lites *Continues on next page.*

Key

- ☐ No Stile Lines
- 🔥 Flush-Glazed Glass with Detailed Sticking (FG)
- ☀️ Low-E Glass (LE)
- 🔲 Simulated Divided Lites (SDL)
- 🔲 Simulated Divided Lites (SDLF2)
- ⬆️ Flat or Contour White Grilles Between Glass (GBGF / GBGC)
- ⬆️ Flat or Contour Almond Grilles Between Glass (GBGF / GBGC)
- ⬆️ Flat or Contour Bronze Grilles Between Glass (GBGF / GBGC)
- ⬆️ Flat or Contour Black Grilles Between Glass (GBGF / GBGC)
- 🌈 NEW Scrolled & Flat Advanta Lite Frame
- 🟢 Vented Sidelite Options
- 6 WBDR Options
- 6 WBDR / HVHZ Options
- E Elevated 10" Bottom Rail Options
- Δ 6'6" Height Available

						
Mahogany	Mahogany	Mahogany	Mahogany	Mahogany	Mahogany	Oak
FCM6124SL 10" x 6'8" 12" x 6'8" Δ (7'0") 14" x 6'8" Δ (7'0")	FCM6125SL 10" x 6'8" 12" x 6'8" Δ (7'0") 14" x 6'8" Δ (7'0")	FCM6126SL 10" x 6'8" 12" x 6'8" Δ (7'0") 14" x 6'8" Δ (7'0")	FCM198 2'8" x 6'8" 2'10" x 6'8" 3'0" x 6'8"	FCM1289 2'6" x 6'8" (7'0") 2'8" x 6'8" (7'0") 2'10" x 6'8" (7'0") 3'0" x 6'8" (7'0")	FCM1289SL 10" x 6'8" 12" x 6'8" Δ (7'0") 14" x 6'8" Δ (7'0")	FC1209 2'6" x 6'8" 2'8" x 6'8" (7'0") 2'10" x 6'8" (7'0") 3'0" x 6'8" (7'0")

						
Oak	Oak	Oak	Oak	Oak	Oak	Oak
FC1201 2'6" x 6'8" Δ (7'0") 2'8" x 6'8" Δ (7'0") 2'10" x 6'8" Δ (7'0") 3'0" x 6'8" Δ (7'0")	FC1211 2'6" x 6'8" 2'8" x 6'8" (7'0") 2'10" x 6'8" (7'0") 3'0" x 6'8" (7'0")	FC1202 2'6" x 6'8" Δ (7'0") 2'8" x 6'8" Δ (7'0") 2'10" x 6'8" Δ (7'0") 3'0" x 6'8" Δ (7'0")	FC1212 2'6" x 6'8" 2'8" x 6'8" (7'0") 2'10" x 6'8" (7'0") 3'0" x 6'8" (7'0")	FC1203 2'6" x 6'8" Δ (7'0") 2'8" x 6'8" Δ (7'0") 2'10" x 6'8" Δ (7'0") 3'0" x 6'8" Δ (7'0")	FC138 2'6" x 6'8" 2'8" x 6'8" (7'0") 2'10" x 6'8" (7'0") 3'0" x 6'8" (7'0")	1285 2'6" x 6'8" Δ (7'0") 2'8" x 6'8" Δ (7'0") 2'10" x 6'8" Δ (7'0") 3'0" x 6'8" Δ (7'0")

						
Oak	Oak	Oak	Oak	Oak	Oak	Oak
FC1208 2'6" x 6'8" 2'8" x 6'8" (7'0") 2'10" x 6'8" (7'0") 3'0" x 6'8" (7'0")	FC1200 2'6" x 6'8" Δ (7'0") 2'8" x 6'8" Δ (7'0") 2'10" x 6'8" Δ (7'0") 3'0" x 6'8" Δ (7'0")	FC18 2'6" x 6'8" 2'8" x 6'8" (7'0") 2'10" x 6'8" (7'0") 3'0" x 6'8" (7'0")	1284 2'6" x 6'8" Δ (7'0") 2'8" x 6'8" Δ (7'0") 2'10" x 6'8" Δ (7'0") 3'0" x 6'8" Δ (7'0")	FC828 2'8" x 8'0" 2'10" x 8'0" 3'0" x 8'0"	81288 2'6" x 8'0" 2'8" x 8'0" 2'10" x 8'0" 3'0" x 8'0"	81208P 2'8" x 8'0" 2'10" x 8'0" 3'0" x 8'0"



Oak

81208

 2'6" x 8'0"
 2'8" x 8'0"
 2'10" x 8'0"
 3'0" x 8'0"



Oak

FC1209SL

 10" x 6'8"
 12" x 6'8"
 14" x 6'8"



Oak

FC1201SL

 12" x 6'8" Δ (7'0")
 14" x 6'8" Δ (7'0")



Oak

FC1211SL

 10" x 6'8"
 12" x 6'8"
 14" x 6'8"



Oak

FC1202SL

 12" x 6'8" Δ (7'0")
 14" x 6'8" Δ (7'0")



Oak

FC1208SL

 10" x 6'8"
 12" x 6'8"
 14" x 6'8"



Oak

FC1200SL

 12" x 6'8" Δ (7'0")
 14" x 6'8" Δ (7'0")



Oak

FC18SL

 10" x 6'8"
 12" x 6'8"
 14" x 6'8"



Oak

12102SL

 12" x 6'8" Δ (7'0")
 14" x 6'8" Δ (7'0")



Oak

81208PSL

 12" x 8'0"
 14" x 8'0"



Oak

81208SL

 12" x 8'0"
 14" x 8'0"



Oak

FC06188SL

 10" x 6'8"
 12" x 6'8"
 14" x 6'8"



Oak

FC06184SL

 12" x 6'8" Δ (7'0")
 14" x 6'8" Δ (7'0")



Oak

FC06189SL

 10" x 6'8"
 12" x 6'8"
 14" x 6'8"



Oak

FC06185SL

 12" x 6'8" Δ (7'0")
 14" x 6'8" Δ (7'0")



Oak

FC06190SL

 10" x 6'8"
 12" x 6'8"
 14" x 6'8"



Oak

FC06186SL

 12" x 6'8" Δ (7'0")
 14" x 6'8" Δ (7'0")



Oak

FC198

 2'6" x 6'8"
 2'8" x 6'8" (7'0")
 2'10" x 6'8" (7'0")
 3'0" x 6'8" (7'0")



Oak

1289

 2'6" x 6'8" Δ (7'0")
 2'8" x 6'8" Δ (7'0")
 2'10" x 6'8" Δ (7'0")
 3'0" x 6'8" Δ (7'0")



Oak

FC198SL

 10" x 6'8"
 12" x 6'8"
 14" x 6'8"



Oak

FC1289SL

 12" x 6'8" Δ (7'0")
 14" x 6'8" Δ (7'0")



Smooth

S1209

 2'6" x 6'8"
 2'8" x 6'8" (7'0")
 2'10" x 6'8" (7'0")
 3'0" x 6'8" (7'0")



Smooth

S1201

 2'6" x 6'8" Δ
 2'8" x 6'8" Δ (7'0")
 2'10" x 6'8" Δ (7'0")
 3'0" x 6'8" Δ (7'0")
 3'6" x 6'8"



Smooth

S1211

 2'6" x 6'8"
 2'8" x 6'8" (7'0")
 2'10" x 6'8" (7'0")
 3'0" x 6'8" (7'0")

Key

No Stile Lines

Low-E Glass (LE)

Simulated Divided Lites (SDL)

Flat or Contour White Grilles Between Glass (GBGF / GBGC)

Flat or Contour Almond Grilles Between Glass (GBGF / GBGC)

Flat or Contour Bronze Grilles Between Glass (GBGF / GBGC)

Flat or Contour Black Grilles Between Glass (GBGF / GBGC)

NEW Scrolled & Flat Advanta Lite Frame

NEW Scrolled Advanta Lite Frame

Vented Sidelite Options

WBDL Options

WBDL / HVHZ Options

6'6" Height Available

Elevated 10" Bottom Rail Options



Smooth

S1202
 E
 2'6" x 6'8" Δ
 2'8" x 6'8" Δ (7'0")
 2'10" x 6'8" Δ (7'0")
 3'0" x 6'8" Δ (7'0")
 3'6" x 6'8"



Smooth

S1212
 E
 2'6" x 6'8"
 2'8" x 6'8" (7'0")
 2'10" x 6'8" (7'0")
 3'0" x 6'8" (7'0")



Smooth

S1203
 E
 2'6" x 6'8" Δ
 2'8" x 6'8" Δ (7'0")
 2'10" x 6'8" Δ (7'0")
 3'0" x 6'8" Δ (7'0")
 3'6" x 6'8"



Smooth

S128
 6E
 2'6" x 6'8"
 2'8" x 6'8" (7'0")
 2'10" x 6'8" (7'0")
 3'0" x 6'8" (7'0")



Smooth

S141
 6E
 2'6" x 6'8" Δ
 2'8" x 6'8" Δ (7'0")
 2'10" x 6'8" Δ (7'0")
 3'0" x 6'8" Δ (7'0")
 3'6" x 6'8"



Smooth

S1208
 6E
 2'6" x 6'8"
 2'8" x 6'8" (7'0")
 2'10" x 6'8" (7'0")
 3'0" x 6'8" (7'0")



Smooth

S1200
 6E
 2'6" x 6'8" Δ
 2'8" x 6'8" Δ (7'0")
 2'10" x 6'8" Δ (7'0")
 3'0" x 6'8" Δ (7'0")
 3'6" x 6'8"



Smooth

S108
 6E
 2'6" x 6'8"
 2'8" x 6'8" (7'0")
 2'10" x 6'8" (7'0")
 3'0" x 6'8" (7'0")



Smooth

S6063
 6E
 2'6" x 6'8" Δ
 2'8" x 6'8" Δ (7'0")
 2'10" x 6'8" Δ (7'0")
 3'0" x 6'8" Δ (7'0")
 3'6" x 6'8"



Smooth

S828
 6
 2'6" x 8'0"
 2'8" x 8'0"
 2'10" x 8'0"
 3'0" x 8'0"



Smooth

S81828
 6
 2'6" x 8'0"
 2'8" x 8'0"
 2'10" x 8'0"
 3'0" x 8'0"
 3'6" x 8'0"



Smooth

S808
 6
 2'6" x 8'0"
 2'8" x 8'0"
 2'10" x 8'0"
 3'0" x 8'0"



Smooth

S81208
 6
 2'6" x 8'0"
 2'8" x 8'0"
 2'10" x 8'0"
 3'0" x 8'0"
 3'6" x 8'0"



Smooth

S1209SL

 12" x 6'8"
 14" x 6'8"



Smooth

S1201SL

 10" x 6'8"
 12" x 6'8" Δ (7'0")
 14" x 6'8" Δ (7'0")



Smooth

S1211SL

 12" x 6'8"
 14" x 6'8"



Smooth

S1202SL

 10" x 6'8"
 12" x 6'8" Δ (7'0")
 14" x 6'8" Δ (7'0")



Smooth

S1208SL
 9
 12" x 6'8"
 14" x 6'8"



Smooth

S1200SL
 9
 10" x 6'8"
 12" x 6'8" Δ (7'0")
 14" x 6'8" Δ (7'0")



Smooth

S308SL
 6
 12" x 6'8"
 14" x 6'8"















































Smooth

S1170SL
 6
 10" x 6'8"
 12" x 6'8" Δ (7'0")
 14" x 6'8" Δ (7'0")



Smooth

S808SL
 6
 12" x 8'0"
 14" x 8'0"

















										
Smooth	Smooth	Smooth	Smooth	Smooth	Smooth					
S81186SL       12" x 8'0" 14" x 8'0"	S605SL   12" x 6'8" 14" x 6'8"	S8605SL   12" x 8'0" 14" x 8'0"	S6124SL      10" x 6'8" 12" x 6'8" Δ (7'0") 14" x 6'8" Δ (7'0")	S85924SL      12" x 8'0" 14" x 8'0"	S606SL   12" x 6'8" 14" x 6'8"	S8606SL   12" x 8'0" 14" x 8'0"	S6125SL      10" x 6'8" 12" x 6'8" Δ (7'0") 14" x 6'8" Δ (7'0")	S85925SL      12" x 8'0" 14" x 8'0"	S607SL   12" x 6'8" 14" x 6'8"	S8607SL   12" x 8'0" 14" x 8'0"

					
Smooth	Smooth	Smooth	Smooth	Smooth	Smooth
S6126SL      10" x 6'8" 12" x 6'8" Δ (7'0") 14" x 6'8" Δ (7'0")	S85926SL      12" x 8'0" 14" x 8'0"	S198       2'6" x 6'8" 2'8" x 6'8" (7'0") 2'10" x 6'8" (7'0") 3'0" x 6'8" (7'0")	S6062       2'6" x 6'8" Δ 2'8" x 6'8" Δ (7'0") 2'10" x 6'8" Δ (7'0") 3'0" x 6'8" Δ (7'0") 3'6" x 6'8"	S198SL     12" x 6'8" 14" x 6'8"	S6062SL       10" x 6'8" 12" x 6'8" Δ (7'0") 14" x 6'8" Δ (7'0")

EnLiten™ Flush-Glazed Clear Glass

						
Oak	Oak	Smooth	Smooth			
2000   2'0" x 6'8" 2'6" x 6'8" 2'8" x 6'8" 3'0" x 6'8"	8000   2'0" x 8'0" 2'6" x 8'0" 2'8" x 8'0" 2'10" x 8'0" 3'0" x 8'0"	2000SL   12" x 6'8" 14" x 6'8"	S2000    2'0" x 6'8" Δ 2'6" x 6'8" Δ 2'8" x 6'8" Δ 2'10" x 6'8" Δ 3'0" x 6'8" Δ	S8000    2'0" x 8'0" 2'6" x 8'0" 2'8" x 8'0" 2'10" x 8'0" 3'0" x 8'0"	S2000SL     10" x 6'8" Δ 12" x 6'8" Δ (7'0") 14" x 6'8" Δ (7'0")	S8000SL   12" x 8'0" 14" x 8'0"

Key

- | | | | | |
|--|--|---|--|--|
|  No Stile Lines |  Flat or Contour White Grilles Between Glass (GBGF / GBGC) |  Flat or Contour Black Grilles Between Glass (GBGF / GBGC) |  WBDR / HVHZ Options |  Elevated 10" Bottom Rail Options |
|  Flush-Glazed Glass with Detailed Sticking (FG) |  Flat or Contour Almond Grilles Between Glass (GBGF / GBGC) |  Fixed Grilles (FXG) |  NEW Scrolled & Flat Advanta Lite Frame |  6'6" Height Available |
|  Low-E Glass (LE) |  Flat or Contour Bronze Grilles Between Glass (GBGF / GBGC) |  Vented Sidelite Options |  NEW Scrolled Advanta Lite Frame | |
|  Simulated Divided Lites (SDL) | |  WBDL Options | | |

Clear Glass



Mahogany

FCM10
 2'8" x 6'8"
 2'10" x 6'8"
 3'0" x 6'8"

FCM870
 2'8" x 8'0"
 2'10" x 8'0"
 3'0" x 8'0"



Mahogany

FCM1283
 2'0" x 6'8"
 2'4" x 6'8"
 2'6" x 6'8" (7'0")
 2'8" x 6'8" (7'0")
 2'10" x 6'8" (7'0")
 3'0" x 6'8" (7'0")

FCM81200
 2'0" x 8'0"
 2'4" x 8'0"
 2'6" x 8'0"
 2'8" x 8'0"
 2'10" x 8'0"
 3'0" x 8'0"



Mahogany

FCM12101SL
 10" x 6'8"
 12" x 6'8" Δ (7'0")
 14" x 6'8" Δ (7'0")

FCM81200SL
 12" x 8'0"
 14" x 8'0"



Mahogany

FCM870SL
 12" x 8'0"
 14" x 8'0"



Oak

FC10
 2'6" x 6'8"
 2'8" x 6'8" (7'0")
 2'10" x 6'8" (7'0")
 3'0" x 6'8" (7'0")

81200P
 2'8" x 8'0"
 2'10" x 8'0"
 3'0" x 8'0"



Oak

1283
 2'0" x 6'8"
 2'4" x 6'8" Δ
 2'6" x 6'8" Δ (7'0")
 2'8" x 6'8" Δ (7'0")
 2'10" x 6'8" Δ (7'0")
 3'0" x 6'8" Δ (7'0")

81200
 2'0" x 8'0"
 2'4" x 8'0"
 2'6" x 8'0"
 2'8" x 8'0"
 2'10" x 8'0"
 3'0" x 8'0"



Oak

FC47SL
 10" x 6'8"
 12" x 6'8"
 14" x 6'8"

81200PSL
 12" x 8'0"
 14" x 8'0"



Oak

12101SL
 12" x 6'8" Δ (7'0")
 14" x 6'8" Δ (7'0")

81200SL
 12" x 8'0"
 14" x 8'0"



Smooth

S118
 2'6" x 6'8"
 2'8" x 6'8" (7'0")
 2'10" x 6'8" (7'0")
 3'0" x 6'8" (7'0")

S818
 2'6" x 8'0"
 2'8" x 8'0"
 2'10" x 8'0"
 3'0" x 8'0"



Smooth

S140
 2'0" x 6'8"
 2'4" x 6'8" Δ
 2'6" x 6'8" Δ
 2'8" x 6'8" Δ (7'0")
 2'10" x 6'8" Δ (7'0")
 3'0" x 6'8" Δ (7'0")
 3'6" x 6'8"

S8140
 2'0" x 8'0"
 2'4" x 8'0"
 2'6" x 8'0"
 2'8" x 8'0"
 2'10" x 8'0"
 3'0" x 8'0"
 3'6" x 8'0"



Smooth

S100SL
 12" x 6'8"
 14" x 6'8"

S8601SL
 12" x 8'0"
 14" x 8'0"



Smooth

S601SL
 10" x 6'8"
 12" x 6'8" Δ (7'0")
 14" x 6'8" Δ (7'0")

S81086SL
 12" x 8'0"
 14" x 8'0"



Direct Set

DRS2131SL
 12" x 6'8" (7'0")
 14" x 6'8" (7'0")

DRS82131SL
 12" x 8'0"
 14" x 8'0"

*Not recommended for use behind storm doors to be painted dark colors, if exposed to direct sunlight.
 Note: See page 299 for important product details that may help with your purchase decision.







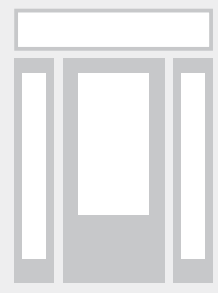

Transoms

For transoms, see page 221.



Blackstone ◆ ◆

					
Mahogany	Mahogany	Oak	Oak	Oak	Smooth
FCM765 6 2'8" x 6'8" 2'10" x 6'8" 3'0" x 6'8"	FCM765SL 6 12" x 6'8" 14" x 6'8"	FCM882SL 6 12" x 8'0" 14" x 8'0"	FC765 6 2'8" x 6'8" 2'10" x 6'8" 3'0" x 6'8"	FC770 6 2'8" x 6'8" 2'10" x 6'8" 3'0" x 6'8"	81952P 6 2'8" x 8'0" 2'10" x 8'0" 3'0" x 8'0"
				FC765SL 6 12" x 6'8" 14" x 6'8"	81952PSL 6 12" x 8'0" 14" x 8'0"
					S975 6 2'8" x 6'8" 2'10" x 6'8" 3'0" x 6'8"

Crystalline ◆ ◆

					
Smooth	Smooth	Mahogany	Mahogany	Oak	Oak
S979 6 2'8" x 6'8" 2'10" x 6'8" 3'0" x 6'8"	S894 6 2'8" x 8'0" 2'10" x 8'0" 3'0" x 8'0"	FCM38 6 2'8" x 6'8" 2'10" x 6'8" 3'0" x 6'8"	FCM38SL 6 12" x 6'8" 14" x 6'8"	FC38 6 2'8" x 6'8" 2'10" x 6'8" 3'0" x 6'8"	FC772 6 2'8" x 6'8" 2'10" x 6'8" 3'0" x 6'8"
			FCM8105SL 6 12" x 8'0" 14" x 8'0"		81953P 6 2'8" x 8'0" 2'10" x 8'0" 3'0" x 8'0"

Crystalline Continues on next page.

Key

- No Stile Lines
- ☀ Low-E Glass (LE)
- 🐢 Turtle Glass
- ◆ Black Nickel Caming (1D)
- Brushed Nickel Caming (1C)
- ▤ Flat Lite Frame
- ▤ NEW Scrolled & Flat Advanta Lite Frame
- Vented Sidelite Options
- 6 WBDR Options
- 6 WBDR / HVHZ Options
- E Elevated 10" Bottom Rail Options
- ⤴ 6'6" Height Available
- ▤ PVC Doorlite Frame*

Crystalline ◆ ■ ■ *Continued*



Oak

FC38SL | 81953PSL
6 | 6
 12" x 6'8" | 12" x 8'0"
 14" x 6'8" | 14" x 8'0"



Smooth

S977
6
 2'8" x 6'8"
 2'10" x 6'8"
 3'0" x 6'8"



Smooth

S981 | S888
6 | 6
 2'8" x 6'8" | 2'8" x 8'0"
 2'10" x 6'8" | 2'10" x 8'0"
 3'0" x 6'8" | 3'0" x 8'0"



Smooth

S758SL | S888SL
6 | 6
 12" x 6'8" | 12" x 8'0"
 14" x 6'8" | 14" x 8'0"



Mahogany

FCM131
 2'8" x 6'8"
 2'10" x 6'8"
 3'0" x 6'8"



Mahogany

FCM131SL | FCM883SL
6 | 6
 12" x 6'8" | 12" x 8'0"
 14" x 6'8" | 14" x 8'0"



Oak

FC131
 2'8" x 6'8"
 2'10" x 6'8"
 3'0" x 6'8"



Oak

FC773
 2'8" x 6'8"
 2'10" x 6'8"
 3'0" x 6'8"



Oak

FC131SL | 81954PSL
6 | 6
 12" x 6'8" | 12" x 8'0"
 14" x 6'8" | 14" x 8'0"



Smooth

S95
 2'8" x 6'8"
 2'10" x 6'8"
 3'0" x 6'8"



Smooth

S91
 2'8" x 6'8"
 2'10" x 6'8"
 3'0" x 6'8"



Smooth

S887 | S91SL | S887SL
6 | 6 | 6
 2'8" x 8'0" | 12" x 6'8" | 12" x 8'0"
 2'10" x 8'0" | 14" x 6'8" | 14" x 8'0"
 3'0" x 8'0" | 14" x 6'8" | 14" x 8'0"

Salinas x



Mahogany

FCM115
6
 2'8" x 6'8"
 2'10" x 6'8"
 3'0" x 6'8"



Mahogany

FCM115SL | FCM884SL
6 | 6
 12" x 6'8" | 12" x 8'0"
 14" x 6'8" | 14" x 8'0"



Oak

FC115
6
 2'8" x 6'8"
 2'10" x 6'8"
 3'0" x 6'8"



Oak

FC775 | 81955P
6 | 6
 2'8" x 6'8" | 2'8" x 8'0"
 2'10" x 6'8" | 2'10" x 8'0"
 3'0" x 6'8" | 3'0" x 8'0"



Oak

FC115SL | 81955PSL
6 | 6
 12" x 6'8" | 12" x 8'0"
 14" x 6'8" | 14" x 8'0"



Smooth

S6009
6
 2'8" x 6'8"
 2'10" x 6'8"
 3'0" x 6'8"

Maple Park ◆◆



Smooth

S6010

6
2'8" x 6'8"
2'10" x 6'8"
3'0" x 6'8"

S895

6
2'8" x 8'0"
2'10" x 8'0"
3'0" x 8'0"



Smooth

S6009SL

6
12" x 6'8"
14" x 6'8"

S895SL

6
12" x 8'0"
14" x 8'0"



Mahogany

FCM902

6
2'8" x 6'8"
2'10" x 6'8"
3'0" x 6'8"



Mahogany

FCM902SL

6
12" x 6'8"
14" x 6'8"

FCM887SL

6
12" x 8'0"
14" x 8'0"



Oak

FC902

6
2'8" x 6'8"
2'10" x 6'8"
3'0" x 6'8"



Oak

FC777

6
2'8" x 6'8"
2'10" x 6'8"
3'0" x 6'8"

81957P

6
2'8" x 8'0"
2'10" x 8'0"
3'0" x 8'0"



Oak

FC902SL

6
12" x 6'8"
14" x 6'8"

81957PSL

6
12" x 8'0"
14" x 8'0"



Smooth

S6102

6
2'8" x 6'8"
2'10" x 6'8"
3'0" x 6'8"



Smooth

S6103

6
2'8" x 6'8"
2'10" x 6'8"
3'0" x 6'8"

S85898

6
2'8" x 8'0"
2'10" x 8'0"
3'0" x 8'0"



Smooth

S6102SL

6
12" x 6'8"
14" x 6'8"

S85898SL

6
12" x 8'0"
14" x 8'0"



Mahogany

FCM764

6
2'8" x 6'8"
2'10" x 6'8"
3'0" x 6'8"



Mahogany

FCM764SL

6
12" x 6'8"
14" x 6'8"

FCM8104SL

6
12" x 8'0"
14" x 8'0"

Avonlea ◆



Oak

FC764

6
2'8" x 6'8"
2'10" x 6'8"
3'0" x 6'8"



Oak

FC769

6
2'8" x 6'8"
2'10" x 6'8"
3'0" x 6'8"

81967P

6
2'8" x 8'0"
2'10" x 8'0"
3'0" x 8'0"



Oak

FC764SL

6
12" x 6'8"
14" x 6'8"

81967PSL

6
12" x 8'0"
14" x 8'0"



Smooth

S976

6
2'8" x 6'8"
2'10" x 6'8"
3'0" x 6'8"



Smooth

S980

6
2'8" x 6'8"
2'10" x 6'8"
3'0" x 6'8"

S85900

6
2'8" x 8'0"
2'10" x 8'0"
3'0" x 8'0"



Smooth

S976SL







6
12" x 6'8"
14" x 6'8"

S85900SL







6
12" x 8'0"
14" x 8'0"

Key







- ◆ Black Nickel Caming (1D)
- ◆ WBDP Options
- ◆◆ Brushed Nickel Caming (1C)
- ◆ WBDP / HVHZ Options
- ✗ Wrought Iron (1W)
- ◆ NEW Scrolled & Flat Advanta Lite Frame

					
Mahogany	Mahogany	Oak	Oak	Oak	Smooth
FCM907 6 2'8" x 6'8" 2'10" x 6'8" 3'0" x 6'8"	FCM907SL 6 12" x 6'8" 14" x 6'8"	FCM889SL 6 12" x 8'0" 14" x 8'0"	FC907 6 2'8" x 6'8" 2'10" x 6'8" 3'0" x 6'8"	FC776 6 2'8" x 6'8" 2'10" x 6'8" 3'0" x 6'8"	81956P 6 2'8" x 8'0" 2'10" x 8'0" 3'0" x 8'0"
FC907SL 6 12" x 6'8" 14" x 6'8"	81956PSL 6 12" x 8'0" 14" x 8'0"	S6092 6 2'8" x 6'8" 2'10" x 6'8" 3'0" x 6'8"			

Texas Star ◆ ◆

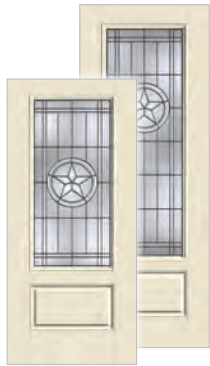
					
Smooth	Smooth	Mahogany	Mahogany	Oak	Oak
S982 6 2'8" x 6'8" 2'10" x 6'8" 3'0" x 6'8"	S891 6 2'8" x 8'0" 2'10" x 8'0" 3'0" x 8'0"	FCM143 6 2'8" x 6'8" 2'10" x 6'8" 3'0" x 6'8"	FCM143SL 6 12" x 6'8" 14" x 6'8"	FCM8103SL 6 12" x 8'0" 14" x 8'0"	FC143 6 2'8" x 6'8" 2'10" x 6'8" 3'0" x 6'8"
S6092SL 6 12" x 6'8" 14" x 6'8"	S891SL 6 12" x 8'0" 14" x 8'0"	FC778 6 2'8" x 6'8" 2'10" x 6'8" 3'0" x 6'8"	81958P 6 2'8" x 8'0" 2'10" x 8'0" 3'0" x 8'0"		

Wellesley™ ◆ ◆ ◆

					
Oak	Smooth	Smooth	Smooth	Mahogany	Mahogany
FC143SL 6 12" x 6'8" 14" x 6'8"	81958PSL 6 12" x 8'0" 14" x 8'0"	S6071 6 2'8" x 6'8" 2'10" x 6'8" 3'0" x 6'8"	S6072 6 2'8" x 6'8" 2'10" x 6'8" 3'0" x 6'8"	S85901 6 2'8" x 8'0" 2'10" x 8'0" 3'0" x 8'0"	S6071SL 6 12" x 6'8" 14" x 6'8"
85901SL 6 12" x 8'0" 14" x 8'0"	FCM147 6 2'8" x 6'8" 2'10" x 6'8" 3'0" x 6'8"	FCM147SL 6 12" x 6'8" 14" x 6'8"	FCM885SL 6 12" x 8'0" 14" x 8'0"		

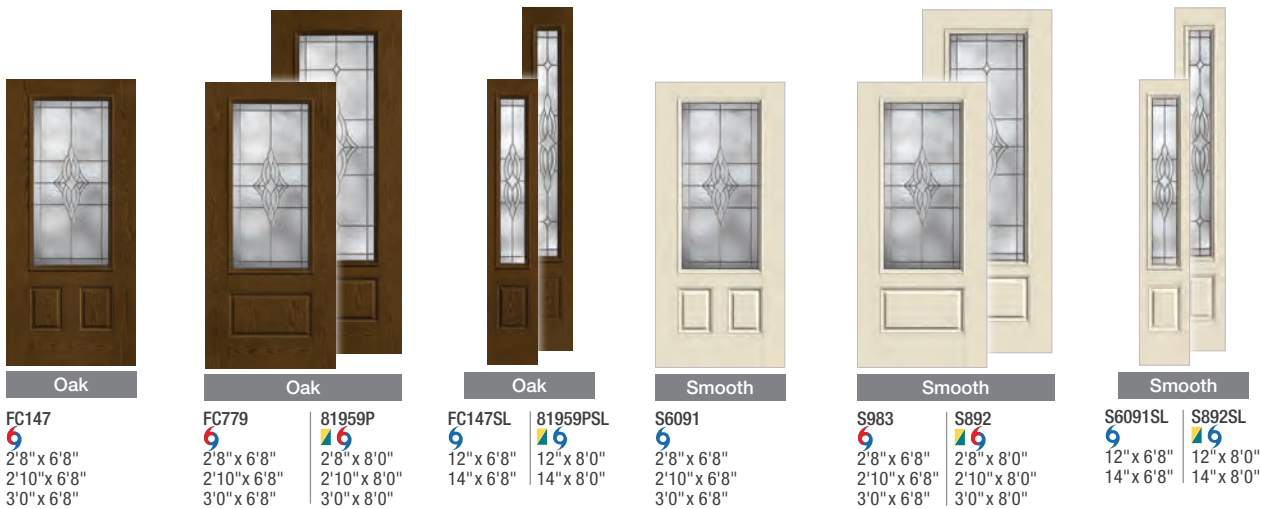

Oak

FC147
6
2'8" x 6'8"
2'10" x 6'8"
3'0" x 6'8"

Oak

FC779
6
2'8" x 6'8"
2'10" x 6'8"
3'0" x 6'8"

Oak

81959P
6
2'8" x 8'0"
2'10" x 8'0"
3'0" x 8'0"

FC147SL
6
12" x 6'8"
14" x 6'8"

81959PSL
6
12" x 8'0"
14" x 8'0"

Smooth

S6091
6
2'8" x 6'8"
2'10" x 6'8"
3'0" x 6'8"

Smooth

S983
6
2'8" x 6'8"
2'10" x 6'8"
3'0" x 6'8"

S892
6
2'8" x 8'0"
2'10" x 8'0"
3'0" x 8'0"

Smooth

S6091SL
6
12" x 6'8"
14" x 6'8"

S892SL
6
12" x 8'0"
14" x 8'0"

Riserva x

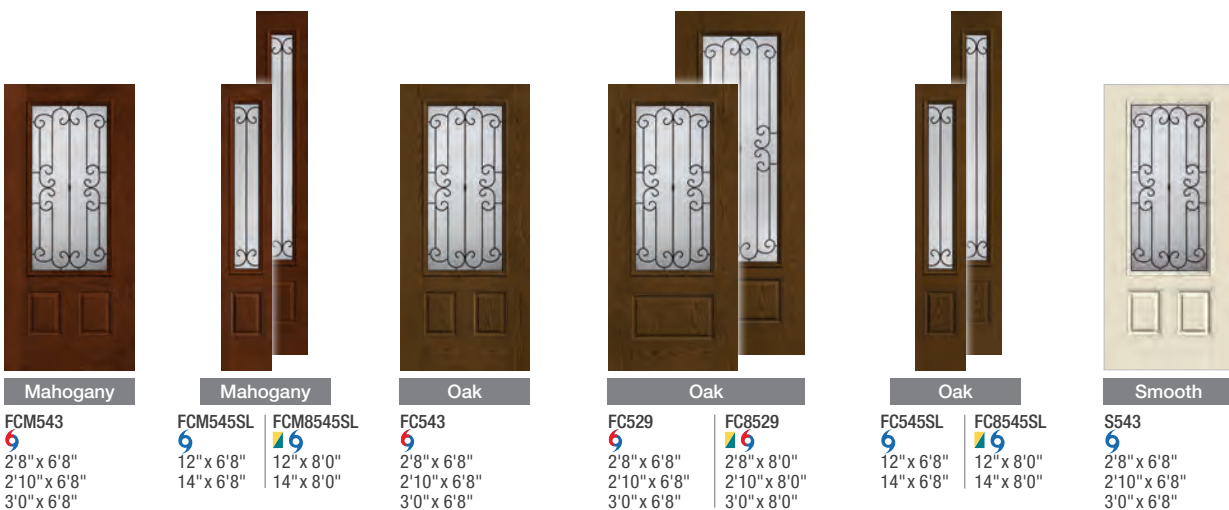

Mahogany

FCM543
6
2'8" x 6'8"
2'10" x 6'8"
3'0" x 6'8"

Mahogany

FCM545SL
6
12" x 6'8"
14" x 6'8"

FCM8545SL
6
12" x 8'0"
14" x 8'0"

Oak

FC543
6
2'8" x 6'8"
2'10" x 6'8"
3'0" x 6'8"

Oak

FC529
6
2'8" x 6'8"
2'10" x 6'8"
3'0" x 6'8"

FC8529
6
2'8" x 8'0"
2'10" x 8'0"
3'0" x 8'0"

Oak

FC545SL
6
12" x 6'8"
14" x 6'8"

FC8545SL
6
12" x 8'0"
14" x 8'0"

Smooth

S543
6
2'8" x 6'8"
2'10" x 6'8"
3'0" x 6'8"

Concorde

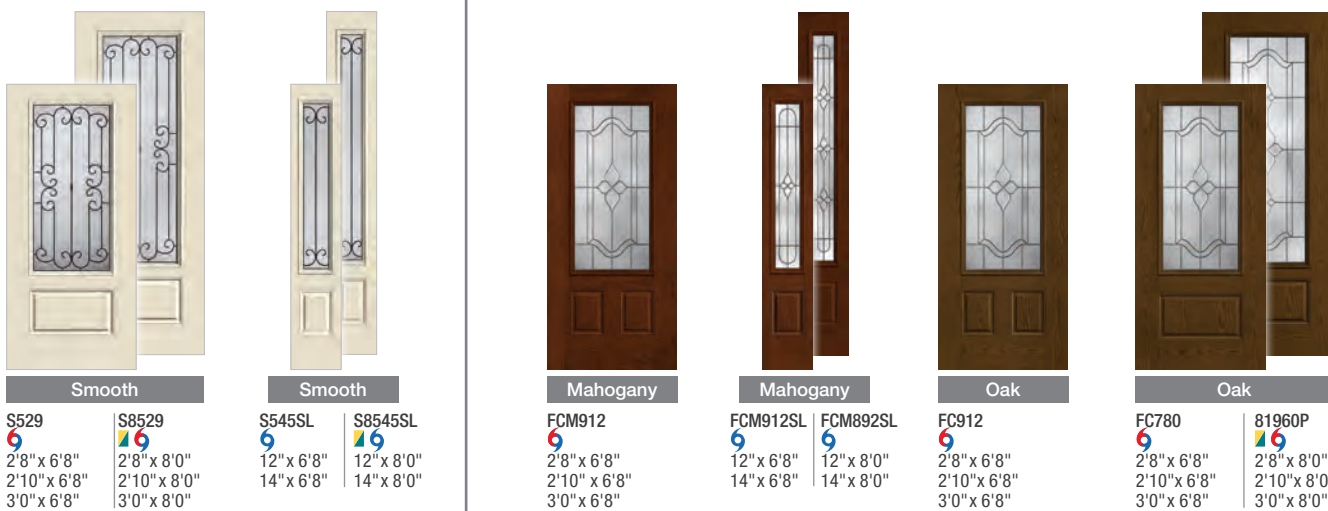

Smooth

S529
6
2'8" x 6'8"
2'10" x 6'8"
3'0" x 6'8"

S8529
6
2'8" x 8'0"
2'10" x 8'0"
3'0" x 8'0"

Smooth

S545SL
6
12" x 6'8"
14" x 6'8"

S8545SL
6
12" x 8'0"
14" x 8'0"

Mahogany

FCM912
6
2'8" x 6'8"
2'10" x 6'8"
3'0" x 6'8"

Mahogany

FCM912SL
6
12" x 6'8"
14" x 6'8"

FCM892SL
6
12" x 8'0"
14" x 8'0"

Oak

FC912
6
2'8" x 6'8"
2'10" x 6'8"
3'0" x 6'8"

Oak

FC780
6
2'8" x 6'8"
2'10" x 6'8"
3'0" x 6'8"

81960P
6
2'8" x 8'0"
2'10" x 8'0"
3'0" x 8'0"

Concorde Continues on next page.

Key

- ◆ Black Nickel Caming (1D)
- Brushed Nickel Caming (1C)
- ◆ Brass Caming (1A)
- ✗ Wrought Iron (1W)
- NEW Scrolled & Flat Advanta Lite Frame
- 6 WBDP Options
- 6 WBDP / HVHZ Options



Oak

FC912SL 81960PSL
 6 6
 12" x 6'8" 12" x 8'0"
 14" x 6'8" 14" x 8'0"



Smooth

S912
 6
 2'8" x 6'8"
 2'10" x 6'8"
 3'0" x 6'8"



Smooth

S97 S85902
 6 6
 2'8" x 6'8" 2'8" x 8'0"
 2'10" x 6'8" 2'10" x 8'0"
 3'0" x 6'8" 3'0" x 8'0"



Smooth

S757SL S85902SL
 6 6
 12" x 6'8" 12" x 8'0"
 14" x 6'8" 14" x 8'0"



Mahogany

FCM156
 6
 2'8" x 6'8"
 2'10" x 6'8"
 3'0" x 6'8"



Mahogany

FCM1442SL FCM8107SL
 6 6
 12" x 6'8" 12" x 8'0"
 14" x 6'8" 14" x 8'0"



Oak

FC156
 6
 2'8" x 6'8"
 2'10" x 6'8"
 3'0" x 6'8"



Oak

FC20042 81961P
 6 6
 2'8" x 6'8" 2'8" x 8'0"
 2'10" x 6'8" 2'10" x 8'0"
 3'0" x 6'8" 3'0" x 8'0"



Oak

FC1442SL 81961PSL
 6 6
 12" x 6'8" 12" x 8'0"
 14" x 6'8" 14" x 8'0"



Smooth

S20042 S902
 6 6
 2'8" x 6'8" 2'8" x 8'0"
 2'10" x 6'8" 2'10" x 8'0"
 3'0" x 6'8" 3'0" x 8'0"



Smooth

S156
 6
 2'8" x 6'8"
 2'10" x 6'8"
 3'0" x 6'8"



Smooth

S1442SL S902SL
 6 6
 12" x 6'8" 12" x 8'0"
 14" x 6'8" 14" x 8'0"



Mahogany

FCM6582
 6
 2'8" x 6'8"
 2'10" x 6'8"
 3'0" x 6'8"



Mahogany

FCM6580SL FCM86580SL
 6 6
 12" x 6'8" 12" x 8'0"
 14" x 6'8" 14" x 8'0"



Oak

FC6582
 6
 2'8" x 6'8"
 2'10" x 6'8"
 3'0" x 6'8"



Oak

FC6580 FC86580
 6 6
 2'8" x 6'8" 2'8" x 8'0"
 2'10" x 6'8" 2'10" x 8'0"
 3'0" x 6'8" 3'0" x 8'0"



Oak

FC6580SL FC86580SL
 6 6
 12" x 6'8" 12" x 8'0"
 14" x 6'8" 14" x 8'0"









Smooth

S6582
 6
 2'8" x 6'8"
 2'10" x 6'8"
 3'0" x 6'8"

Note: See page 299 for important product details that may help with your purchase decision.





Smooth

S6580	S86580
 2'8" x 6'8"	 2'8" x 8'0"
 2'10" x 6'8"	 2'10" x 8'0"
 3'0" x 6'8"	 3'0" x 8'0"



Smooth

S6580SL	S86580SL
 12" x 6'8"	 12" x 8'0"
 14" x 6'8"	 14" x 8'0"







Mahogany

FCM1647
 2'8" x 6'8"
 2'10" x 6'8"
 3'0" x 6'8"



Mahogany

FCM1646SL	FCM81646SL
 12" x 6'8"	 12" x 8'0"
 14" x 6'8"	 14" x 8'0"



Oak

FC1647
 2'8" x 6'8"
 2'10" x 6'8"
 3'0" x 6'8"



Oak

FC1646	FC81646
 2'8" x 6'8"	 2'8" x 8'0"
 2'10" x 6'8"	 2'10" x 8'0"
 3'0" x 6'8"	 3'0" x 8'0"





Oak

FC1646SL	FC81646SL
 12" x 6'8"	 12" x 8'0"
 14" x 6'8"	 14" x 8'0"







Smooth

S1647
 2'8" x 6'8"
 2'10" x 6'8"
 3'0" x 6'8"





Smooth

S1646	S81646
 2'8" x 6'8"	 2'8" x 8'0"
 2'10" x 6'8"	 2'10" x 8'0"
 3'0" x 6'8"	 3'0" x 8'0"









Smooth

S1646SL	S81646SL
 12" x 6'8"	 12" x 8'0"
 14" x 6'8"	 14" x 8'0"







Key





-  Black Nickel Caming (1D)
-  Brushed Nickel Caming (1C)
-  Brass Caming (1A)
-  NEW Scrolled & Flat Advanta Lite Frame
-  WBDR Options
-  WBDR / HVHZ Options

Frosted Images®

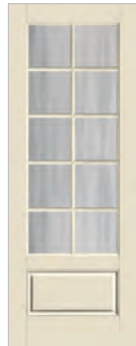

EnLiten™ Flush-Glazed Privacy & Textured Glass with Divided Lites







		
Mahogany	Oak	Smooth
FCM8109SL 6 12" x 8'0" 14" x 8'0"	81963PSL 6 12" x 8'0" 14" x 8'0"	S884SL 6 12" x 8'0" 14" x 8'0"

			
Smooth	Smooth	Smooth	Smooth
S2103_ 2'6" x 6'8" 2'8" x 6'8" 2'10" x 6'8" 3'0" x 6'8"	S82103_ 2'6" x 8'0" 2'8" x 8'0" 2'10" x 8'0" 3'0" x 8'0"	S2104_ 2'6" x 6'8" 2'8" x 6'8" 2'10" x 6'8" 3'0" x 6'8"	S82105_ 2'6" x 8'0" 2'8" x 8'0" 2'10" x 8'0" 3'0" x 8'0"
	S82106_ 2'6" x 8'0" 2'8" x 8'0" 2'10" x 8'0" 3'0" x 8'0"		

				
Smooth	Smooth	Smooth	Smooth	Smooth
S2250_ 2'6" x 6'8" 2'8" x 6'8" 2'10" x 6'8" 3'0" x 6'8"	S82107_ 2'6" x 8'0" 2'8" x 8'0" 2'10" x 8'0" 3'0" x 8'0"	S2103_SL 12" x 6'8" 14" x 6'8"	S2104_SL 12" x 6'8" 14" x 6'8"	S2250_SL 12" x 6'8" 14" x 6'8"

Privacy & Textured Glass with Divided Lites

		
Mahogany	Mahogany	Mahogany
FCM82_ 2'8" x 6'8" 2'10" x 6'8" 3'0" x 6'8"	FCM92_SL 12" x 6'8" 14" x 6'8"	FCM8101_SL 12" x 8'0" 14" x 8'0"

					
Oak	Oak	Oak	Oak	Oak	Oak
FC82_ 2'8" x 6'8" 2'10" x 6'8" 3'0" x 6'8"	FC92_ 2'8" x 6'8" 2'10" x 6'8" 3'0" x 6'8"	81945P_ 2'8" x 8'0" 2'10" x 8'0" 3'0" x 8'0"	81946P_ 2'8" x 8'0" 2'10" x 8'0" 3'0" x 8'0"	FC92_SL 12" x 6'8" 14" x 6'8"	81946P_SL 12" x 8'0" 14" x 8'0"

Privacy & Textured Glass Options				
Add the code to the blank in the style number for the desired door and glass combination. For details on glass options, see page 139.				
XK = Reeded	XE = Satin Etch	XJ = Chinchilla	XN = Granite	
XG = Geometric	XC = Chord	XR = Rainglass		

*Not available with Geometric (XG) glass.
Note: See page 299 for important product details that may help with your purchase decision.

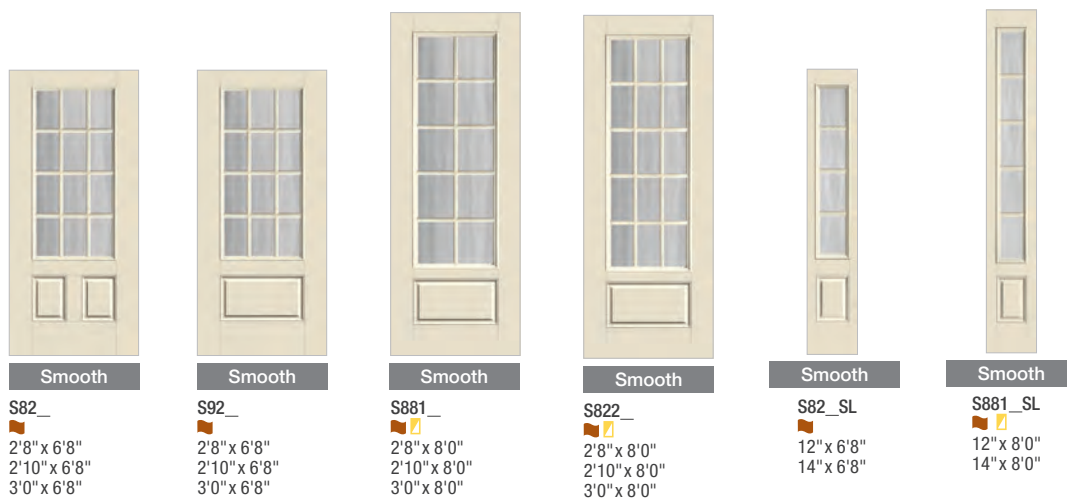

S82_ 2'8" x 6'8" 2'10" x 6'8" 3'0" x 6'8"	S92_ 2'8" x 6'8" 2'10" x 6'8" 3'0" x 6'8"	S881_ 2'8" x 8'0" 2'10" x 8'0" 3'0" x 8'0"	S822_ 2'8" x 8'0" 2'10" x 8'0" 3'0" x 8'0"	S82_SL 12" x 6'8" 14" x 6'8"	S881_SL 12" x 8'0" 14" x 8'0"
---	---	--	--	---	--

EnLiten™ Flush-Glazed Privacy & Textured Glass

Privacy & Textured Glass

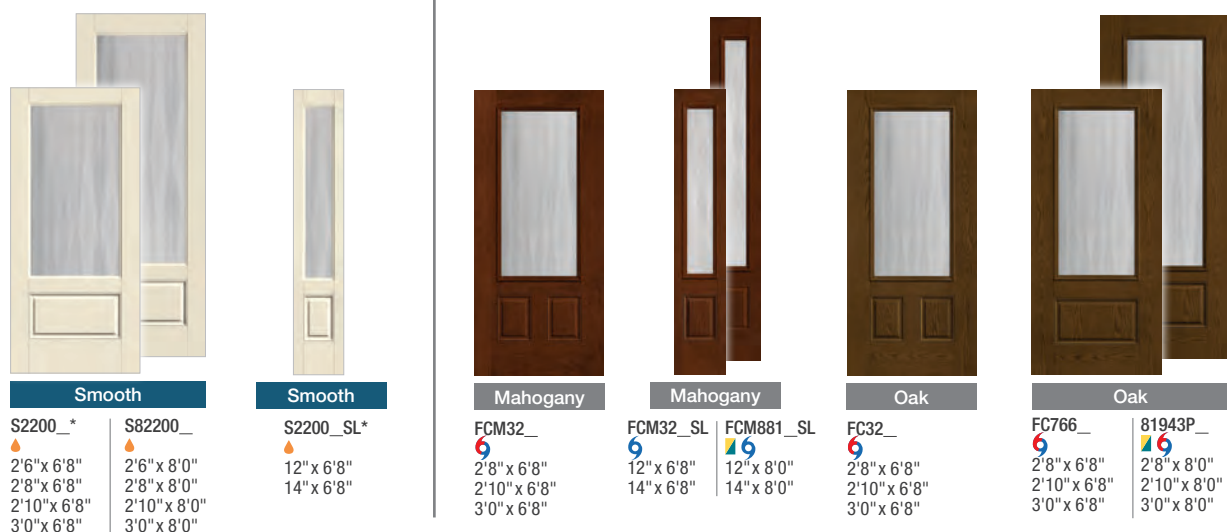

S2200_* 2'6" x 6'8" 2'8" x 6'8" 2'10" x 6'8" 3'0" x 6'8"	S82200_ 2'6" x 8'0" 2'8" x 8'0" 2'10" x 8'0" 3'0" x 8'0"	S2200_SL* 12" x 6'8" 14" x 6'8"	FCM32_ 2'8" x 6'8" 2'10" x 6'8" 3'0" x 6'8"	FCM32_SL 12" x 6'8" 14" x 6'8"	FCM881_SL 12" x 8'0" 14" x 8'0"	FC32_ 2'8" x 6'8" 2'10" x 6'8" 3'0" x 6'8"	FC766_ 2'8" x 6'8" 2'10" x 6'8" 3'0" x 6'8"	81943P_ 2'8" x 8'0" 2'10" x 8'0" 3'0" x 8'0"
---	---	--	---	---	--	--	---	--

Internal Blinds

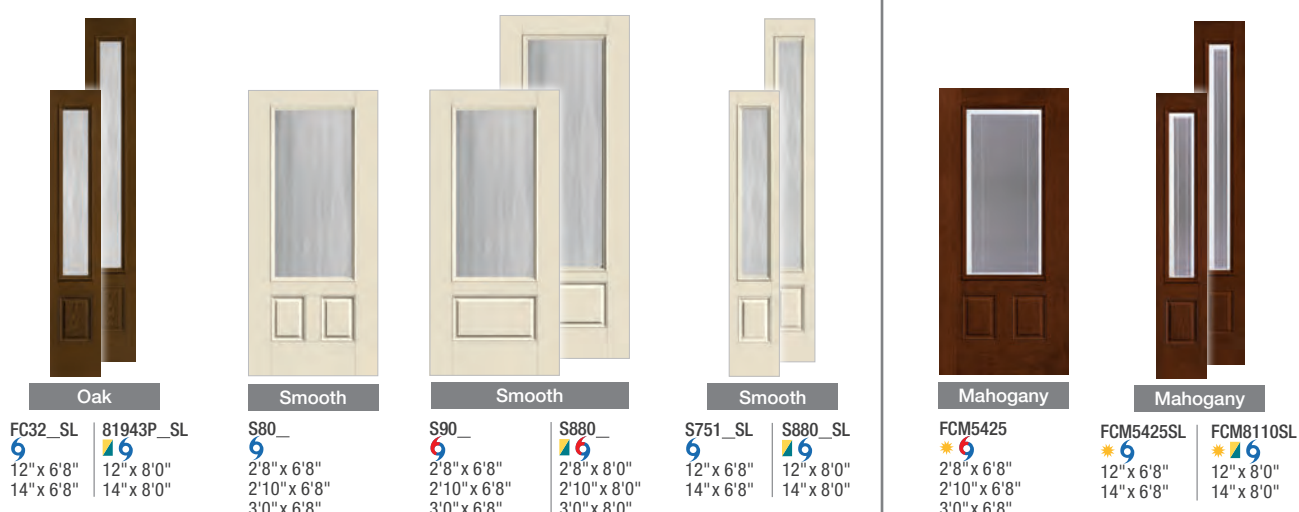

FC32_SL 12" x 6'8" 14" x 6'8"	81943P_SL 12" x 8'0" 14" x 8'0"	S80_ 2'8" x 6'8" 2'10" x 6'8" 3'0" x 6'8"	S90_ 2'8" x 6'8" 2'10" x 6'8" 3'0" x 6'8"	S880_ 2'8" x 8'0" 2'10" x 8'0" 3'0" x 8'0"	S751_SL 12" x 6'8" 14" x 6'8"	S880_SL 12" x 8'0" 14" x 8'0"	FCM5425 2'8" x 6'8" 2'10" x 6'8" 3'0" x 6'8"	FCM5425SL 12" x 6'8" 14" x 6'8"	FCM8110SL 12" x 8'0" 14" x 8'0"
--	--	---	---	--	--	--	--	--	--

Internal Blinds *Continues on next page.*











Key

- Flush-Glazed Glass with Detailed Sticking (FG)
- Simulated Divided Lites (SDL)
- WBDRO Options
- Low-E Glass (LE)
- NEW Scrolled & Flat Advanta Lite Frame
- WBDRO / HVHZ Options
- NEW Scrolled Advanta Lite Frame











Internal Blinds

									
Oak	Oak	Oak	Smooth	Smooth	Smooth				
FC5425 ★ 6 2'8" x 6'8" 2'10" x 6'8" 3'0" x 6'8"	1964P ★ 6 2'8" x 6'8" 2'10" x 6'8" 3'0" x 6'8"	81964P ★ 6 2'8" x 8'0" 2'10" x 8'0" 3'0" x 8'0"	FC5425SL ★ 6 12" x 6'8" 14" x 6'8"	81964PSL ★ 6 12" x 8'0" 14" x 8'0"	S5425 ★ 6 2'8" x 6'8" 2'10" x 6'8" 3'0" x 6'8"	S682 ★ 6 2'8" x 6'8" 2'10" x 6'8" 3'0" x 6'8"	S8682 ★ 6 2'8" x 8'0" 2'10" x 8'0" 3'0" x 8'0"	S5425SL ★ 6 12" x 6'8" 14" x 6'8"	S8682SL ★ 6 12" x 8'0" 14" x 8'0"

EnLiten™ Flush-Glazed Clear Glass with Divided Lites

					
Smooth	Smooth	Smooth	Smooth	Smooth	Smooth
S2103 ★ 6 2'6" x 6'8" 2'8" x 6'8" 2'10" x 6'8" 3'0" x 6'8"	S82103 ★ 6 2'6" x 8'0" 2'8" x 8'0" 2'10" x 8'0" 3'0" x 8'0"	S2104 ★ 6 2'6" x 6'8" 2'8" x 6'8" 2'10" x 6'8" 3'0" x 6'8"	S82104 ★ 6 2'6" x 8'0" 2'8" x 8'0" 2'10" x 8'0" 3'0" x 8'0"	S2105 ★ 6 2'6" x 6'8" 2'8" x 6'8" 2'10" x 6'8" 3'0" x 6'8"	S82105 ★ 6 2'6" x 8'0" 2'8" x 8'0" 2'10" x 8'0" 3'0" x 8'0"
					
Smooth	Smooth	Smooth	Smooth	Smooth	
S2103SL ★ 6 12" x 6'8" 14" x 6'8"	S2104SL ★ 6 12" x 6'8" 14" x 6'8"	S92SL ★ 6 12" x 6'8" 14" x 6'8"	S1401 ★ 6 2'6" x 6'8" 2'8" x 6'8" 2'10" x 6'8" 3'0" x 6'8"	S81401 ★ 6 2'6" x 8'0" 2'8" x 8'0" 2'10" x 8'0" 3'0" x 8'0"	S1401SL ★ 6 12" x 6'8" 14" x 6'8"

Clear Glass with Divided Lites

								
Mahogany	Mahogany	Mahogany	Mahogany	Mahogany	Mahogany			
FCM2106 ★♦♦♦ 2'8" x 6'8" 2'10" x 6'8" 3'0" x 6'8"	FCM2107 ★♦♦♦6 2'8" x 6'8" 2'10" x 6'8" 3'0" x 6'8"	FCM2108 ★♦♦♦ 2'8" x 6'8" 2'10" x 6'8" 3'0" x 6'8"	FCM82 ★♦♦♦6 2'8" x 6'8" 2'10" x 6'8" 3'0" x 6'8"	FCM1089SL ★♦♦♦ 12" x 6'8" 14" x 6'8"	FCM8311SL ★♦♦♦ 12" x 8'0" 14" x 8'0"			
								
Mahogany	Mahogany	Mahogany	Mahogany	Mahogany	Mahogany	Mahogany	Mahogany	Mahogany
FCM92SL ★♦♦♦ 12" x 6'8" 14" x 6'8"	FCM8310SL ★♦♦♦6 12" x 8'0" 14" x 8'0"	FCM8101SL ★♦♦♦ 12" x 8'0" 14" x 8'0"	FCM81900SL ★♦♦ 12" x 8'0" 14" x 8'0"	FCM81947SL ★♦♦ 12" x 8'0" 14" x 8'0"	FCM81949SL ★♦♦ 12" x 8'0" 14" x 8'0"	FCM1402 ★♦♦♦ 2'8" x 6'8" 2'10" x 6'8" 3'0" x 6'8"	FCM2101SL ★♦♦♦6 12" x 6'8" 14" x 6'8"	FCM8313SL ★♦♦♦6 12" x 8'0" 14" x 8'0"
								
Oak	Oak	Oak	Oak	Oak	Oak	Oak	Oak	
FC2106 ★♦♦♦ 2'8" x 6'8" 2'10" x 6'8" 3'0" x 6'8"	FC2107 ★♦♦♦6 2'8" x 6'8" 2'10" x 6'8" 3'0" x 6'8"	FC2108 ★♦♦♦ 2'8" x 6'8" 2'10" x 6'8" 3'0" x 6'8"	FC82 ★♦♦♦6 2'8" x 6'8" 2'10" x 6'8" 3'0" x 6'8"	FC1089 ★♦♦♦ 2'8" x 6'8" 2'10" x 6'8" 3'0" x 6'8"	FC8311 ★♦♦♦ 2'8" x 8'0" 2'10" x 8'0" 3'0" x 8'0"	FC2101 ★♦♦♦6 2'8" x 6'8" 2'10" x 6'8" 3'0" x 6'8"	FC8313 ★♦♦♦6 2'8" x 8'0" 2'10" x 8'0" 3'0" x 8'0"	

Clear Glass with Divided Lites *Continues on next page.*

Key

-  Flush-Glazed Glass with Detailed Sticking (FG)
-  Low-E Glass (LE)
-  Simulated Divided Lites (SDL)
-  Simulated Divided Lites (SDLF1)
-  Flat or Contour White Grilles Between Glass (GBGF / GBGC)
-  Flat or Contour Almond Grilles Between Glass (GBGF / GBGC)
-  Flat or Contour Bronze Grilles Between Glass (GBGF / GBGC)
-  Flat or Contour Black Grilles Between Glass (GBGF / GBGC)
-  **NEW** Scrolled & Flat Advanta Lite Frame
-  **NEW** Scrolled Advanta Lite Frame
-  WBDR Options
-  WBDR / HVHZ Options

Clear Glass with Divided Lites *Continued*

Fiber-Classic® & Smooth-Star®



Oak

FC2102



2'8" x 6'8"

2'10" x 6'8"

3'0" x 6'8"

FC8316



2'8" x 8'0"

2'10" x 8'0"

3'0" x 8'0"



Oak

81945P



2'8" x 8'0"

2'10" x 8'0"

3'0" x 8'0"



Oak

FC92



2'8" x 6'8"

2'10" x 6'8"

3'0" x 6'8"

FC8310



2'8" x 8'0"

2'10" x 8'0"

3'0" x 8'0"



Oak

81946P



2'8" x 8'0"

2'10" x 8'0"

3'0" x 8'0"



Oak

FC1089SL



12" x 6'8"

14" x 6'8"

FC8311SL



12" x 8'0"

14" x 8'0"



Oak

FC2101SL



12" x 6'8"

14" x 6'8"

FC8313SL



12" x 8'0"

14" x 8'0"



Oak

FC92SL



12" x 6'8"

14" x 6'8"

FC8310SL



12" x 8'0"

14" x 8'0"



Oak

81946PSL



12" x 8'0"

14" x 8'0"



Oak

81900PSL



12" x 8'0"

14" x 8'0"



Oak

81947PSL



12" x 8'0"

14" x 8'0"



Oak

81949PSL



12" x 8'0"

14" x 8'0"



Oak

FC1402



2'8" x 6'8"

2'10" x 6'8"

3'0" x 6'8"



Oak

FC1400



2'8" x 6'8"

2'10" x 6'8"

3'0" x 6'8"

81944P



2'8" x 8'0"

2'10" x 8'0"

3'0" x 8'0"



Oak

FC1400SL



12" x 6'8"

14" x 6'8"

81944PSL



12" x 8'0"

14" x 8'0"



Smooth

S2106



2'8" x 6'8"

2'10" x 6'8"

3'0" x 6'8"



Smooth

S2107



2'8" x 6'8"

2'10" x 6'8"

3'0" x 6'8"



Smooth

S2108



2'8" x 6'8"

2'10" x 6'8"

3'0" x 6'8"



Smooth

S82



2'8" x 6'8"

2'10" x 6'8"

3'0" x 6'8"



Smooth

S1089



2'8" x 6'8"

2'10" x 6'8"

3'0" x 6'8"

S8311



2'8" x 8'0"

2'10" x 8'0"

3'0" x 8'0"



Smooth

S2101
 * * * * * 6
 2'8" x 6'8"
 2'10" x 6'8"
 3'0" x 6'8"

S8313
 * * * * *
 2'8" x 8'0"
 2'10" x 8'0"
 3'0" x 8'0"



Smooth

S2102
 * * * * *
 2'8" x 6'8"
 2'10" x 6'8"
 3'0" x 6'8"

S8316
 * * * * *
 2'8" x 8'0"
 2'10" x 8'0"
 3'0" x 8'0"



Smooth

S881
 * * * * *
 2'8" x 8'0"
 2'10" x 8'0"
 3'0" x 8'0"



Smooth

S92
 * * * * * 6
 2'8" x 6'8"
 2'10" x 6'8"
 3'0" x 6'8"



Smooth

S8310
 * * * * * 6
 2'8" x 8'0"
 2'10" x 8'0"
 3'0" x 8'0"



Smooth

S882
 * * * * *
 2'8" x 8'0"
 2'10" x 8'0"
 3'0" x 8'0"



Smooth

S1089SL
 * * * * *
 12" x 6'8"
 14" x 6'8"



Smooth

S8311SL
 * * * * *
 12" x 8'0"
 14" x 8'0"



Smooth

S2101SL
 * * * * *
 12" x 6'8"
 14" x 6'8"



Smooth

S8313SL
 * * * * *
 12" x 8'0"
 14" x 8'0"



Smooth

S82SL
 * * * * *
 12" x 6'8"
 14" x 6'8"



Smooth

S8310SL
 * * * * *
 12" x 8'0"
 14" x 8'0"



Smooth

S881SL
 * * * * *
 12" x 8'0"
 14" x 8'0"



Smooth

S8207SL
 * * * * *
 12" x 8'0"
 14" x 8'0"



Smooth

S8202SL
 * * * * *
 12" x 8'0"
 14" x 8'0"



Smooth

S8204SL
 * * * * *
 12" x 8'0"
 14" x 8'0"

EnLiten™ Flush-Glazed Clear Glass



Smooth

S1402
 * * * * *
 2'8" x 6'8"
 2'10" x 6'8"
 3'0" x 6'8"



Smooth

S1400
 * * * * *
 2'8" x 6'8"
 2'10" x 6'8"
 3'0" x 6'8"



Smooth

S898
 * * * * * 6
 2'8" x 8'0"
 2'10" x 8'0"
 3'0" x 8'0"

S898
 * * * * * 6
 2'8" x 8'0"
 2'10" x 8'0"
 3'0" x 8'0"

S1400SL
 * * * * *
 12" x 6'8"
 14" x 6'8"

S898SL
 * * * * *
 12" x 8'0"
 14" x 8'0"



Smooth

S2200
 * * * * *
 2'6" x 6'8"
 2'8" x 6'8"
 2'10" x 6'8"
 3'0" x 6'8"



Smooth

S82200
 * * * * *
 2'6" x 8'0"
 2'8" x 8'0"
 2'10" x 8'0"
 3'0" x 8'0"

S90SL
 * * * * *
 12" x 6'8"
 14" x 6'8"

Key

- Flush-Glazed Glass with Detailed Sticking (FG)
- Low-E Glass (LE)
- Simulated Divided Lites (SDL)

- Flat or Contour White Grilles Between Glass (GBGF / GBGC)
- Flat or Contour Almond Grilles Between Glass (GBGF / GBGC)

- Flat or Contour Bronze Grilles Between Glass (GBGF / GBGC)
- Flat or Contour Black Grilles Between Glass (GBGF / GBGC)
- Fixed Grilles (FXG)

- NEW Scrolled & Flat Advanta Lite Frame
- NEW Scrolled Advanta Lite Frame
- WBDR Options

- WBDR / HVHZ Options

Clear Glass

Fiber-Classic® & Smooth-Star®

								
Mahogany	Mahogany	Oak	Oak	Oak	Smooth			
FCM32 ★ 6 2'8" x 6'8" 2'10" x 6'8" 3'0" x 6'8"	FCM32SL ★ 6 12" x 6'8" 14" x 6'8"	FCM881SL ★ 6 12" x 8'0" 14" x 8'0"	FC32 ★ 6 2'8" x 6'8" 2'10" x 6'8" 3'0" x 6'8"	FC766 ★ 6 2'8" x 6'8" 2'10" x 6'8" 3'0" x 6'8"	81943P ★ 6 2'8" x 8'0" 2'10" x 8'0" 3'0" x 8'0"	FC32SL ★ 6 12" x 6'8" 14" x 6'8"	81943PSL ★ 6 12" x 8'0" 14" x 8'0"	S80 ★ 6 2'8" x 6'8" 2'10" x 6'8" 3'0" x 6'8"

			
Smooth	Smooth		
S90 ★ 6 2'8" x 6'8" 2'10" x 6'8" 3'0" x 6'8"	S880 ★ 6 2'8" x 8'0" 2'10" x 8'0" 3'0" x 8'0"	S751SL ★ 6 12" x 6'8" 14" x 6'8"	S880SL ★ 6 12" x 8'0" 14" x 8'0"



Note: See page 299 for important product details that may help with your purchase decision.

Bottom: Smooth-Star, Clear Glass with GBGs, Doors – S82103, Finish – Onyx

Right Page: Fiber-Classic Mahogany Collection, Concorde Glass, Door – FCM916, Sidelites – FCM809SL, Finish – Rustic Clay



Transoms

For transoms, see page 221.

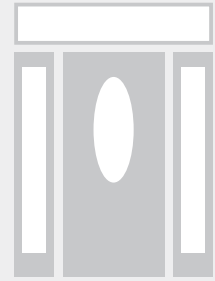

Blackstone ♦ ❖



Mahogany

FCM110
2'8" x 6'8"
2'10" x 6'8"
3'0" x 6'8"



Mahogany

FCM164
2'8" x 6'8"
2'10" x 6'8"
3'0" x 6'8"



Oak

FC714
2'8" x 6'8"
2'10" x 6'8"
3'0" x 6'8"



Oak

FC164
2'8" x 6'8"
2'10" x 6'8"
3'0" x 6'8"



Oak

FC794
2'8" x 6'8"
2'10" x 6'8"
3'0" x 6'8"



Smooth

S771
2'8" x 6'8"
2'10" x 6'8"
3'0" x 6'8"



Smooth

S6085
2'8" x 6'8"
2'10" x 6'8"
3'0" x 6'8"

Avonlea ♦



Smooth

S997
2'8" x 6'8"
2'10" x 6'8"
3'0" x 6'8"



Mahogany

FCM785
2'8" x 6'8"
2'10" x 6'8"
3'0" x 6'8"

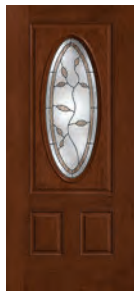

Mahogany

FCM788
2'8" x 6'8"
2'10" x 6'8"
3'0" x 6'8"



Oak

FC785
2'8" x 6'8"
2'10" x 6'8"
3'0" x 6'8"



Oak

FC788
2'8" x 6'8"
2'10" x 6'8"
3'0" x 6'8"



Oak

FC792
2'8" x 6'8"
2'10" x 6'8"
3'0" x 6'8"



Smooth

S988
2'8" x 6'8"
2'10" x 6'8"
3'0" x 6'8"

Key

- Low-E Glass (LE)
- Turtle Glass
- Black Nickel Caming (1D)
- Brushed Nickel Caming (1C)
- NEW** Scrolled & Flat Advanta Lite Frame
- WBDR Options
- WBDR / HVHZ Options

Avonlea *Continues on next page.*

Avonlea ♦ Continued



Smooth

S991
2'8" x 6'8"
2'10" x 6'8"
3'0" x 6'8"



Smooth

S995
2'8" x 6'8"
2'10" x 6'8"
3'0" x 6'8"

Wellesley™ ♦ ♦ ♦



Mahogany

FCM106
2'8" x 6'8"
2'10" x 6'8"
3'0" x 6'8"



Mahogany

FCM163
2'8" x 6'8"
2'10" x 6'8"
3'0" x 6'8"



Oak

FC713
2'8" x 6'8"
2'10" x 6'8"
3'0" x 6'8"



Oak

FC163
2'8" x 6'8"
2'10" x 6'8"
3'0" x 6'8"



Oak

FC796
2'8" x 6'8"
2'10" x 6'8"
3'0" x 6'8"

Concorde™ ♦ ♦ ♦



Smooth

S774
2'8" x 6'8"
2'10" x 6'8"
3'0" x 6'8"



Smooth

S6082
2'8" x 6'8"
2'10" x 6'8"
3'0" x 6'8"



Smooth

S999
2'8" x 6'8"
2'10" x 6'8"
3'0" x 6'8"



Mahogany

FCM916
2'8" x 6'8"
2'10" x 6'8"
3'0" x 6'8"



Mahogany

FCM915
2'8" x 6'8"
2'10" x 6'8"
3'0" x 6'8"



Oak

FC916
2'8" x 6'8"
2'10" x 6'8"
3'0" x 6'8"



Oak

FC915
2'8" x 6'8"
2'10" x 6'8"
3'0" x 6'8"

Kensington™ ♦ ♦ ♦



Oak

FC797
2'8" x 6'8"
2'10" x 6'8"
3'0" x 6'8"



Smooth

S773
2'8" x 6'8"
2'10" x 6'8"
3'0" x 6'8"



Smooth

S6084
2'8" x 6'8"
2'10" x 6'8"
3'0" x 6'8"



Smooth

S1000
2'8" x 6'8"
2'10" x 6'8"
3'0" x 6'8"



Mahogany

FCM151
2'8" x 6'8"
2'10" x 6'8"
3'0" x 6'8"



Mahogany

FCM789
2'8" x 6'8"
2'10" x 6'8"
3'0" x 6'8"



Oak

FC709
2'8" x 6'8"
2'10" x 6'8"
3'0" x 6'8"

Pembridge™ ♦ ♦ ♦



Oak

FC151
2'8" x 6'8"
2'10" x 6'8"
3'0" x 6'8"



Oak

FC798
2'8" x 6'8"
2'10" x 6'8"
3'0" x 6'8"



Smooth

S709
2'8" x 6'8"
2'10" x 6'8"
3'0" x 6'8"



Smooth

S163
2'8" x 6'8"
2'10" x 6'8"
3'0" x 6'8"



Smooth

S1001
2'8" x 6'8"
2'10" x 6'8"
3'0" x 6'8"



Mahogany

FCM6577
2'8" x 6'8"
2'10" x 6'8"
3'0" x 6'8"



Mahogany

FCM6575
2'8" x 6'8"
2'10" x 6'8"
3'0" x 6'8"

Oak	Oak	Oak	Smooth	Smooth	Smooth
FC6577 2'8" x 6'8" 2'10" x 6'8" 3'0" x 6'8"	FC06575 2'8" x 6'8" 2'10" x 6'8" 3'0" x 6'8"	FC6576 2'8" x 6'8" 2'10" x 6'8" 3'0" x 6'8"	S6577 2'8" x 6'8" 2'10" x 6'8" 3'0" x 6'8"	S6575 2'8" x 6'8" 2'10" x 6'8" 3'0" x 6'8"	S6576 2'8" x 6'8" 2'10" x 6'8" 3'0" x 6'8"

Frosted Images®

Mahogany	Mahogany	Oak	Oak	Oak	Smooth	Smooth	Smooth
FCM784 2'8" x 6'8" 2'10" x 6'8" 3'0" x 6'8"	FCM787 2'8" x 6'8" 2'10" x 6'8" 3'0" x 6'8"	FC784 2'8" x 6'8" 2'10" x 6'8" 3'0" x 6'8"	FC787 2'8" x 6'8" 2'10" x 6'8" 3'0" x 6'8"	FC791 2'8" x 6'8" 2'10" x 6'8" 3'0" x 6'8"	S989 2'8" x 6'8" 2'10" x 6'8" 3'0" x 6'8"	S6081 2'8" x 6'8" 2'10" x 6'8" 3'0" x 6'8"	S994 2'8" x 6'8" 2'10" x 6'8" 3'0" x 6'8"

Clear Glass

Mahogany	Mahogany	Oak	Oak	Oak	Smooth	Smooth	Smooth
FCM80 * 2'8" x 6'8" 2'10" x 6'8" 3'0" x 6'8"	FCM160 * 2'8" x 6'8" 2'10" x 6'8" 3'0" x 6'8"	FC710 * 2'8" x 6'8" 2'10" x 6'8" 3'0" x 6'8"	FC160 * 2'8" x 6'8" 2'10" x 6'8" 3'0" x 6'8"	FC789 * 2'8" x 6'8" 2'10" x 6'8" 3'0" x 6'8"	S770 * 2'8" x 6'8" 2'10" x 6'8" 3'0" x 6'8"	S6080 * 2'8" x 6'8" 2'10" x 6'8" 3'0" x 6'8"	S992 * 2'8" x 6'8" 2'10" x 6'8" 3'0" x 6'8"

Key

- Low-E Glass (LE)
- Black Nickel Caming (1D)
- Brushed Nickel Caming (1C)
- Brass Caming (1A)







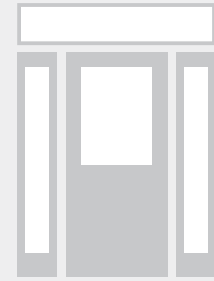







Transoms

For transoms, see page 221.



Blackstone ◆ ◆

										
Mahogany	Mahogany	Mahogany	Mahogany	Oak	Oak	Oak				
FCM109 2'8" x 6'8" 2'10" x 6'8" 3'0" x 6'8"	FCM863 2'8" x 8'0" 2'10" x 8'0" 3'0" x 8'0"	FCM6032 2'8" x 6'8" 2'10" x 6'8" 3'0" x 6'8"	FCM6052 2'8" x 6'8" 2'10" x 6'8" 3'0" x 6'8"	FCM109SL 12" x 6'8" 14" x 6'8"	FCM863SL 12" x 8'0" 14" x 8'0"	FC109 2'6" x 6'8" 2'8" x 6'8" (7'0") 2'10" x 6'8" (7'0") 3'0" x 6'8" (7'0")	81933P 2'8" x 8'0" 2'10" x 8'0" 3'0" x 8'0"	81975P 2'8" x 8'0" 2'10" x 8'0" 3'0" x 8'0"	FC109SL 12" x 6'8" 14" x 6'8"	81933PSL 12" x 8'0" 14" x 8'0"

								
Smooth	Smooth	Smooth	Smooth	Smooth				
S6000 2'6" x 6'8" 2'8" x 6'8" (7'0") 2'10" x 6'8" (7'0") 3'0" x 6'8" (7'0")	S81933P 2'8" x 8'0" 2'10" x 8'0" 3'0" x 8'0"	S6032 2'8" x 6'8" (7'0") 2'10" x 6'8" (7'0") 3'0" x 6'8" (7'0")	S86032 2'8" x 8'0" 2'10" x 8'0" 3'0" x 8'0"	S6052 2'8" x 6'8" 2'10" x 6'8" 3'0" x 6'8"	S972 2'8" x 6'8" 2'10" x 6'8" 3'0" x 6'8"	S85905 2'8" x 8'0" 2'10" x 8'0" 3'0" x 8'0"	S6000SL 12" x 6'8" 14" x 6'8"	S85912SL 12" x 8'0" 14" x 8'0"

Note: See page 299 for important product details that may help with your purchase decision.

Top: Impressions Storm & Entry Door System – IM100, Finish – Brown; Fiber-Classic Oak Collection, Clear Glass with SDLs, Door – 2150, Finish – Driftwood



Mahogany

FCM45 6	FCM898 6
2'8" x 6'8"	2'8" x 8'0"
2'10" x 6'8"	2'10" x 8'0"
3'0" x 6'8"	3'0" x 8'0"



Mahogany

FCM6027 6
2'8" x 6'8"
2'10" x 6'8"
3'0" x 6'8"



Mahogany

FCM6047 6
2'8" x 6'8"
2'10" x 6'8"
3'0" x 6'8"



Mahogany

FCM45SL 6	FCM898SL 6
12" x 6'8"	12" x 8'0"
14" x 6'8"	14" x 8'0"



Oak

FC45 6E	81935P 6
2'8" x 6'8" (7'0")	2'8" x 8'0"
2'10" x 6'8" (7'0")	2'10" x 8'0"
3'0" x 6'8" (7'0")	3'0" x 8'0"



Oak

81977P 6
2'8" x 8'0"
2'10" x 8'0"
3'0" x 8'0"



Oak

FC43SL 6	81935PSL 6
12" x 6'8"	12" x 8'0"
14" x 6'8"	14" x 8'0"



Smooth

S926 6E	S81935P 6
2'8" x 6'8" (7'0")	2'8" x 8'0"
2'10" x 6'8" (7'0")	2'10" x 8'0"
3'0" x 6'8" (7'0")	3'0" x 8'0"



Smooth

S6027 6E	S86027 6E
2'8" x 6'8" (7'0")	2'8" x 8'0"
2'10" x 6'8" (7'0")	2'10" x 8'0"
3'0" x 6'8" (7'0")	3'0" x 8'0"



Smooth

S6047 6
2'8" x 6'8"
2'10" x 6'8"
3'0" x 6'8"



Smooth

S38 6	S85907 6
2'8" x 6'8"	2'8" x 8'0"
2'10" x 6'8"	2'10" x 8'0"
3'0" x 6'8"	3'0" x 8'0"



Smooth

S930SL 6	S85914SL 6
12" x 6'8"	12" x 8'0"
14" x 6'8"	14" x 8'0"

Sedona ◆ ■



Mahogany

FCM101 6	FCM864 6
2'8" x 6'8"	2'8" x 8'0"
2'10" x 6'8"	2'10" x 8'0"
3'0" x 6'8"	3'0" x 8'0"



Mahogany

FCM6025 6
2'8" x 6'8"
2'10" x 6'8"
3'0" x 6'8"



Mahogany

FCM6045 6
2'8" x 6'8"
2'10" x 6'8"
3'0" x 6'8"



Mahogany

FCM101SL 6	FCM864SL 6
12" x 6'8"	12" x 8'0"
14" x 6'8"	14" x 8'0"



Oak

FC101 E	81936P 6
2'6" x 6'8"	2'8" x 8'0"
2'8" x 6'8" (7'0")	2'10" x 8'0"
2'10" x 6'8" (7'0")	3'0" x 8'0"
3'0" x 6'8" (7'0")	



Oak

81978P 6
2'8" x 8'0"
2'10" x 8'0"
3'0" x 8'0"

Sedona Continues on next page.

Key

- ◆ Black Nickel Caming (1D)
- Brushed Nickel Caming (1C)
- 6 WBDR Options
- 6 WBDR / HVHZ Options

E Elevated 10" Bottom Rail Options

Sedona ♦ ♦ Continued

Fiber-Classic® & Smooth-Star®



Oak

FC101SL 12" x 6'8"
14" x 6'8"

81936PSL 12" x 8'0"
14" x 8'0"



Smooth

S211
E 2'6" x 6'8"
2'8" x 6'8" (7'0")
2'10" x 6'8" (7'0")
3'0" x 6'8" (7'0")

S81936P 2'8" x 8'0"
2'10" x 8'0"
3'0" x 8'0"



Smooth

S6025
E 2'8" x 6'8" (7'0")
2'10" x 6'8" (7'0")
3'0" x 6'8" (7'0")

S86025 2'8" x 8'0"
2'10" x 8'0"
3'0" x 8'0"



Smooth

S6045 2'8" x 6'8"
2'10" x 6'8"
3'0" x 6'8"



Smooth

S35 2'8" x 6'8"
2'10" x 6'8"
3'0" x 6'8"

S833 2'8" x 8'0"
2'10" x 8'0"
3'0" x 8'0"



Smooth

S294SL 12" x 6'8"
14" x 6'8"

S85915SL 12" x 8'0"
14" x 8'0"

Salinas x



Mahogany

FCM114
6 2'8" x 6'8"
2'10" x 6'8"
3'0" x 6'8"

FCM865
6 2'8" x 8'0"
2'10" x 8'0"
3'0" x 8'0"

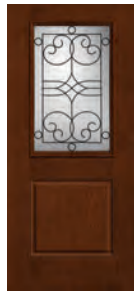

Mahogany

FCM6031
6 2'8" x 6'8"
2'10" x 6'8"
3'0" x 6'8"

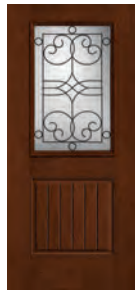

Mahogany

FCM6051
6 2'8" x 6'8"
2'10" x 6'8"
3'0" x 6'8"



Mahogany

FCM114SL
6 12" x 6'8"
14" x 6'8"

FCM865SL
6 12" x 8'0"
14" x 8'0"



Oak

FC114
6E 2'6" x 6'8"
2'8" x 6'8" (7'0")
2'10" x 6'8" (7'0")
3'0" x 6'8" (7'0")

81937P
6 2'8" x 8'0"
2'10" x 8'0"
3'0" x 8'0"



Oak

81980P
6 2'8" x 8'0"
2'10" x 8'0"
3'0" x 8'0"



Oak

FCM114SL
6 12" x 6'8"
14" x 6'8"

81937PSL
6 12" x 8'0"
14" x 8'0"



Smooth

S6006
6E 2'6" x 6'8"
2'8" x 6'8" (7'0")
2'10" x 6'8" (7'0")
3'0" x 6'8" (7'0")

S81937P
6 2'8" x 8'0"
2'10" x 8'0"
3'0" x 8'0"



Smooth

S6031
6E 2'8" x 6'8" (7'0")
2'10" x 6'8" (7'0")
3'0" x 6'8" (7'0")

S86031
6E 2'8" x 8'0"
2'10" x 8'0"
3'0" x 8'0"



Smooth

S6051
6 2'8" x 6'8"
2'10" x 6'8"
3'0" x 6'8"



Smooth

S973
6 2'8" x 6'8"
2'10" x 6'8"
3'0" x 6'8"

S893
6 2'8" x 8'0"
2'10" x 8'0"
3'0" x 8'0"



Smooth

S6006SL
6 12" x 6'8"
14" x 6'8"

S85916SL
6 12" x 8'0"
14" x 8'0"

Maple Park. ◆ ■



Mahogany

FCM901
6
2'8" x 6'8"
2'10" x 6'8"
3'0" x 6'8"

FCM886
6
2'8" x 8'0"
2'10" x 8'0"
3'0" x 8'0"



Mahogany

FCM6107
6
2'8" x 6'8"
2'10" x 6'8"
3'0" x 6'8"



Mahogany

FCM6108
6
2'8" x 6'8"
2'10" x 6'8"
3'0" x 6'8"



Mahogany

FCM901SL
6
12" x 6'8"
14" x 6'8"

FCM886SL
6
12" x 8'0"
14" x 8'0"



Oak

FC901
6 E
2'8" x 6'8" (7'0")
2'10" x 6'8" (7'0")
3'0" x 6'8" (7'0")

81939P
6
2'8" x 8'0"
2'10" x 8'0"
3'0" x 8'0"



Oak

81982P
6
2'8" x 8'0"
2'10" x 8'0"
3'0" x 8'0"



Oak

FC901SL
6
12" x 6'8"
14" x 6'8"

81939PSL
6
12" x 8'0"
14" x 8'0"



Smooth

S6101
6 E
2'8" x 6'8" (7'0")
2'10" x 6'8" (7'0")
3'0" x 6'8" (7'0")

S81939P
6
2'8" x 8'0"
2'10" x 8'0"
3'0" x 8'0"



Smooth

S6107
6 E
2'8" x 6'8" (7'0")
2'10" x 6'8" (7'0")
3'0" x 6'8" (7'0")

S86107
6 E
2'8" x 8'0"
2'10" x 8'0"
3'0" x 8'0"



Smooth

S6108
6
2'8" x 6'8"
2'10" x 6'8"
3'0" x 6'8"



Smooth

S6106
6
2'8" x 6'8"
2'10" x 6'8"
3'0" x 6'8"

S85897
6
2'8" x 8'0"
2'10" x 8'0"
3'0" x 8'0"



Smooth

S6101SL
6
12" x 6'8"
14" x 6'8"

S85918SL
6
12" x 8'0"
14" x 8'0"

Avonlea. ◆



Mahogany

FCM761
6
2'8" x 6'8"
2'10" x 6'8"
3'0" x 6'8"

FCM896
6
2'8" x 8'0"
2'10" x 8'0"
3'0" x 8'0"



Mahogany

FCM968
6
2'8" x 6'8"
2'10" x 6'8"
3'0" x 6'8"



Mahogany

FCM966
6
2'8" x 6'8"
2'10" x 6'8"
3'0" x 6'8"



Mahogany

FCM761SL
6
12" x 6'8"
14" x 6'8"

FCM896SL
6
12" x 8'0"
14" x 8'0"



Oak

FC761
6 E
2'8" x 6'8" (7'0")
2'10" x 6'8" (7'0")
3'0" x 6'8" (7'0")

81932P
6
2'8" x 8'0"
2'10" x 8'0"
3'0" x 8'0"



Oak







81974P
6
2'8" x 8'0"
2'10" x 8'0"
3'0" x 8'0"

Avonlea Continues on next page.

Key



- ◆ Black Nickel Caming (1D)
- Brushed Nickel Caming (1C)
- ✕ Wrought Iron (1W)

- 6 WBDP Options
- 6 WBDP / HVHZ Options
- E Elevated 10" Bottom Rail Options







										
Oak	Smooth	Smooth	Smooth	Smooth	Smooth					
FC761SL 6 12" x 6'8" 14" x 6'8"	81932PSL 6 12" x 8'0" 14" x 8'0"	S964 6E 2'8" x 6'8" (7'0") 2'10" x 6'8" (7'0") 3'0" x 6'8" (7'0")	S81932P 6 2'8" x 8'0" 2'10" x 8'0" 3'0" x 8'0"	S968 6E 2'8" x 6'8" (7'0") 2'10" x 6'8" (7'0") 3'0" x 6'8" (7'0")	S8968 6E 2'8" x 8'0" 2'10" x 8'0" 3'0" x 8'0"	S966 6 2'8" x 6'8" 2'10" x 6'8" 3'0" x 6'8"	S970 6 2'8" x 6'8" 2'10" x 6'8" 3'0" x 6'8"	S85906 6 2'8" x 8'0" 2'10" x 8'0" 3'0" x 8'0"	S964SL 6 12" x 6'8" 14" x 6'8"	S85911SL 6 12" x 8'0" 14" x 8'0"





Saratoga™ ♦

								
Mahogany	Mahogany	Mahogany	Mahogany	Oak	Oak			
FCM906 6 2'8" x 6'8" 2'10" x 6'8" 3'0" x 6'8"	FCM888 6 2'8" x 8'0" 2'10" x 8'0" 3'0" x 8'0"	FCM6029 6 2'8" x 6'8" 2'10" x 6'8" 3'0" x 6'8"	FCM6049 6 2'8" x 6'8" 2'10" x 6'8" 3'0" x 6'8"	FCM906SL 6 12" x 6'8" 14" x 6'8"	FCM888SL 6 12" x 8'0" 14" x 8'0"	FC906 6E 2'6" x 6'8" 2'8" x 6'8" (7'0") 2'10" x 6'8" (7'0") 3'0" x 6'8" (7'0")	81938P 6 2'8" x 8'0" 2'10" x 8'0" 3'0" x 8'0"	81981P 6 2'8" x 8'0" 2'10" x 8'0" 3'0" x 8'0"







										
Oak	Smooth	Smooth	Smooth	Smooth	Smooth					
FC906SL 6 12" x 6'8" 14" x 6'8"	81938PSL 6 12" x 8'0" 14" x 8'0"	S213 6E 2'6" x 6'8" 2'8" x 6'8" (7'0") 2'10" x 6'8" (7'0") 3'0" x 6'8" (7'0")	S81938P 6 2'8" x 8'0" 2'10" x 8'0" 3'0" x 8'0"	S6029 6E 2'8" x 6'8" (7'0") 2'10" x 6'8" (7'0") 3'0" x 6'8" (7'0")	S86029 6E 2'8" x 8'0" 2'10" x 8'0" 3'0" x 8'0"	S6049 6 2'8" x 6'8" 2'10" x 6'8" 3'0" x 6'8"	S41 6 2'8" x 6'8" 2'10" x 6'8" 3'0" x 6'8"	S85908 6 2'8" x 8'0" 2'10" x 8'0" 3'0" x 8'0"	S291SL 6 12" x 6'8" 14" x 6'8"	S85917SL 6 12" x 8'0" 14" x 8'0"

Texas Star ◆ ❖ ❖

							
Mahogany	Mahogany	Mahogany	Mahogany	Oak	Oak	Oak	
FCM144 6 2'8" x 6'8" 2'10" x 6'8" 3'0" x 6'8"	FCM899 6 2'8" x 8'0" 2'10" x 8'0" 3'0" x 8'0"	FCM6074 6 2'8" x 6'8" 2'10" x 6'8" 3'0" x 6'8"	FCM6075 6 2'8" x 6'8" 2'10" x 6'8" 3'0" x 6'8"	FCM899SL 6 12" x 8'0" 14" x 8'0"	FC144 6 E 2'8" x 6'8" (7'0") 2'10" x 6'8" (7'0") 3'0" x 6'8" (7'0")	81940P 6 2'8" x 8'0" 2'10" x 8'0" 3'0" x 8'0"	81983P 6 2'8" x 8'0" 2'10" x 8'0" 3'0" x 8'0"

				
Smooth	Smooth	Smooth	Smooth	Smooth
S6073 6 E 2'8" x 6'8" (7'0") 2'10" x 6'8" (7'0") 3'0" x 6'8" (7'0")	S81940P 6 2'8" x 8'0" 2'10" x 8'0" 3'0" x 8'0"	S6074 6 E 2'8" x 6'8" (7'0") 2'10" x 6'8" (7'0") 3'0" x 6'8" (7'0")	S86074 6 E 2'8" x 8'0" 2'10" x 8'0" 3'0" x 8'0"	S6075 6 2'8" x 6'8" 2'10" x 6'8" 3'0" x 6'8"
S6076 6 2'8" x 6'8" 2'10" x 6'8" 3'0" x 6'8"	S81983 6 2'8" x 8'0" 2'10" x 8'0" 3'0" x 8'0"	85919SL 6 12" x 8'0" 14" x 8'0"		







Wellesley ◆ ❖ ❖

					
Mahogany	Mahogany	Mahogany	Mahogany	Oak	Oak
FCM105 6 2'8" x 6'8" 2'10" x 6'8" 3'0" x 6'8"	FCM866 6 2'8" x 8'0" 2'10" x 8'0" 3'0" x 8'0"	FCM6030 6 2'8" x 6'8" 2'10" x 6'8" 3'0" x 6'8"	FCM6050 6 2'8" x 6'8" 2'10" x 6'8" 3'0" x 6'8"	FCM105SL 6 12" x 6'8" 14" x 6'8"	FCM866SL 6 12" x 8'0" 14" x 8'0"
FC105 6 E 2'6" x 6'8" 2'8" x 6'8" (7'0") 2'10" x 6'8" (7'0") 3'0" x 6'8" (7'0")	81941P 6 2'8" x 8'0" 2'10" x 8'0" 3'0" x 8'0"	81984P 6 2'8" x 8'0" 2'10" x 8'0" 3'0" x 8'0"			







Wellesley Continues on next page.







Key

- ◆ Black Nickel Caming (1D)
- ❖ Brushed Nickel Caming (1C)
- ❖ Brass Caming (1A)
- 6 WBDR Options
- 6 WBDR / HVHZ Options
- E Elevated 10" Bottom Rail Options

										
Oak	Smooth	Smooth	Smooth	Smooth	Smooth					
FC105SL 6 12"x 6'8" 14"x 6'8"	81941PSL 6 12"x 8'0" 14"x 8'0"	S214 6E 2'6"x 6'8" 2'8"x 6'8" (7'0") 2'10"x 6'8" (7'0") 3'0"x 6'8" (7'0")	S81941P 6 2'8"x 8'0" 2'10"x 8'0"	S6030 6E 2'8"x 6'8" (7'0") 2'10"x 6'8" (7'0") 3'0"x 6'8" (7'0")	S86030 6E 2'8"x 8'0" 2'10"x 8'0" 3'0"x 8'0"	S6050 6 2'8"x 6'8" 2'10"x 6'8" 3'0"x 6'8"	S42 6 2'8"x 6'8" 2'10"x 6'8" 3'0"x 6'8"	S85909 6 2'8"x 8'0" 2'10"x 8'0" 3'0"x 8'0"	S292SL 6 12"x 6'8" 14"x 6'8"	S85922SL 6 12"x 8'0" 14"x 8'0"

Riserva x

								
Mahogany	Mahogany	Mahogany	Mahogany	Oak	Oak			
FCM581 6 2'8"x 6'8" 2'10"x 6'8" 3'0"x 6'8"	FCM8581 6 2'8"x 8'0" 2'10"x 8'0" 3'0"x 8'0"	FCM575 6 2'8"x 6'8" 2'10"x 6'8" 3'0"x 6'8"	FCM577 6 2'8"x 6'8" 2'10"x 6'8" 3'0"x 6'8"	FCM583SL 6 12"x 6'8" 14"x 6'8"	FCM8583SL 6 12"x 8'0" 14"x 8'0"	FC581 6E 2'6"x 6'8" 2'8"x 6'8" (7'0") 2'10"x 6'8" (7'0") 3'0"x 6'8" (7'0")	FC8581 6 2'8"x 8'0" 2'10"x 8'0" 3'0"x 8'0"	FC8579 6 2'8"x 8'0" 2'10"x 8'0" 3'0"x 8'0"

										
Oak	Smooth	Smooth	Smooth	Smooth	Smooth					
FC583SL 6 12"x 6'8" 14"x 6'8"	FC8583SL 6 12"x 8'0" 14"x 8'0"	S581 6E 2'6"x 6'8" 2'8"x 6'8" (7'0") 2'10"x 6'8" (7'0") 3'0"x 6'8" (7'0")	S8581 6 2'8"x 8'0" 2'10"x 8'0"	S575 6E 2'8"x 6'8" (7'0") 2'10"x 6'8" (7'0") 3'0"x 6'8" (7'0")	S8575 6E 2'8"x 8'0" 2'10"x 8'0" 3'0"x 8'0"	S577 6 2'8"x 6'8" 2'10"x 6'8" 3'0"x 6'8"	S579 6 2'8"x 6'8" 2'10"x 6'8" 3'0"x 6'8"	S8579 6 2'8"x 8'0" 2'10"x 8'0" 3'0"x 8'0"	S583SL 6 12"x 6'8" 14"x 6'8"	S8583SL 6 12"x 8'0" 14"x 8'0"



Mahogany

FCM911
 2'8" x 6'8"
 2'10" x 6'8"
 3'0" x 6'8"

FCM891
 2'8" x 8'0"
 2'10" x 8'0"
 3'0" x 8'0"



Mahogany

FCM6026
 2'8" x 6'8"
 2'10" x 6'8"
 3'0" x 6'8"

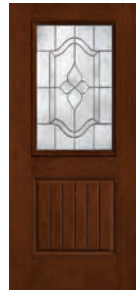

Mahogany

FCM6046
 2'8" x 6'8"
 2'10" x 6'8"
 3'0" x 6'8"



Mahogany

FCM911SL
 12" x 6'8"
 14" x 6'8"

FCM891SL
 12" x 8'0"
 14" x 8'0"



Oak

FC911
 2'6" x 6'8"
 2'8" x 6'8" (7'0")
 2'10" x 6'8" (7'0")
 3'0" x 6'8" (7'0")

81942P
 2'8" x 8'0"
 2'10" x 8'0"
 3'0" x 8'0"



Oak

81985P
 2'8" x 8'0"
 2'10" x 8'0"
 3'0" x 8'0"



Oak

FC911SL
 12" x 6'8"
 14" x 6'8"

81942PSL
 12" x 8'0"
 14" x 8'0"



Smooth

S426
 2'6" x 6'8"
 2'8" x 6'8" (7'0")
 2'10" x 6'8" (7'0")
 3'0" x 6'8" (7'0")

S81942P
 2'8" x 8'0"
 2'10" x 8'0"
 3'0" x 8'0"



Smooth

S6026
 2'8" x 6'8" (7'0")
 2'10" x 6'8" (7'0")
 3'0" x 6'8" (7'0")

S86026
 2'8" x 8'0"
 2'10" x 8'0"
 3'0" x 8'0"



Smooth

S6046
 2'8" x 6'8"
 2'10" x 6'8"
 3'0" x 6'8"



Smooth

S37
 2'8" x 6'8"
 2'10" x 6'8"
 3'0" x 6'8"

S837
 2'8" x 8'0"
 2'10" x 8'0"
 3'0" x 8'0"



Smooth

S430SL
 12" x 6'8"
 14" x 6'8"

S85920SL
 12" x 8'0"
 14" x 8'0"

Kensington™ ◆ ■



Mahogany

FCM149
 2'8" x 6'8"
 2'10" x 6'8"
 3'0" x 6'8"

FCM8149
 2'8" x 8'0"
 2'10" x 8'0"
 3'0" x 8'0"



Mahogany

FCM6036
 2'8" x 6'8"
 2'10" x 6'8"
 3'0" x 6'8"



Mahogany

FCM6056
 2'8" x 6'8"
 2'10" x 6'8"
 3'0" x 6'8"



Mahogany

FCM149SL
 12" x 6'8"
 14" x 6'8"

FCM867SL
 12" x 8'0"
 14" x 8'0"



Oak

FC149
 2'8" x 6'8" (7'0")
 2'10" x 6'8" (7'0")
 3'0" x 6'8" (7'0")

FC8149
 2'8" x 8'0"
 2'10" x 8'0"
 3'0" x 8'0"



Oak

FC89701
 2'8" x 8'0"
 2'10" x 8'0"
 3'0" x 8'0"







Kensington Continues on next page.







Key

















- ◆ Black Nickel Caming (1D)
- Brushed Nickel Caming (1C)
- ◆ Brass Caming (1A)
- ✗ Wrought Iron (1W)
- 6 WBDR Options
- 6 WBDR / HVHZ Options
- E Elevated 10" Bottom Rail Options





















										
Oak	Smooth	Smooth	Smooth	Smooth	Smooth					
FC149SL 6 12" x 6'8" 14" x 6'8"	FC8867SL 6 12" x 8'0" 14" x 8'0"	S161 6E 2'8" x 6'8" (7'0") 2'10" x 6'8" (7'0") 3'0" x 6'8" (7'0")	S8149 6 2'8" x 8'0" 2'10" x 8'0" 3'0" x 8'0"	S6036 6E 2'8" x 6'8" (7'0") 2'10" x 6'8" (7'0") 3'0" x 6'8" (7'0")	S86036 6E 2'8" x 8'0" 2'10" x 8'0" 3'0" x 8'0"	S6056 6 2'8" x 6'8" 2'10" x 6'8" 3'0" x 6'8"	S43 6 2'8" x 6'8" 2'10" x 6'8" 3'0" x 6'8"	S89701 6 2'8" x 8'0" 2'10" x 8'0" 3'0" x 8'0"	S161SL 6 12" x 6'8" 14" x 6'8"	S867SL 6 12" x 8'0" 14" x 8'0"

Pembridge™   

















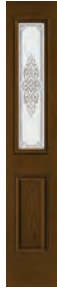





								
Mahogany	Mahogany	Mahogany	Mahogany	Oak	Oak			
FCM6560 6 2'8" x 6'8" 2'10" x 6'8" 3'0" x 6'8"	FCM86560 6 2'8" x 8'0" 2'10" x 8'0" 3'0" x 8'0"	FCM6565 6 2'8" x 6'8" 2'10" x 6'8" 3'0" x 6'8"	FCM6568 6 2'8" x 6'8" 2'10" x 6'8" 3'0" x 6'8"	FCM6565SL 6 12" x 6'8" 14" x 6'8"	FCM86560SL 6 12" x 8'0" 14" x 8'0"	FC6560 6E 2'6" x 6'8" 2'8" x 6'8" (7'0") 2'10" x 6'8" (7'0") 3'0" x 6'8" (7'0")	FC86560 6 2'8" x 8'0" 2'10" x 8'0" 3'0" x 8'0"	FC86536 6 2'8" x 8'0" 2'10" x 8'0" 3'0" x 8'0"

										
Oak	Smooth	Smooth	Smooth	Smooth	Smooth					
FC6565SL 6 12" x 6'8" 14" x 6'8"	FC86560SL 6 12" x 8'0" 14" x 8'0"	S6560 6E 2'6" x 6'8" 2'8" x 6'8" (7'0") 2'10" x 6'8" (7'0") 3'0" x 6'8" (7'0")	S86560 6 2'8" x 8'0" 2'10" x 8'0" 3'0" x 8'0"	S6565 6E 2'8" x 6'8" (7'0") 2'10" x 6'8" (7'0") 3'0" x 6'8" (7'0")	S86565 6E 2'8" x 8'0" 2'10" x 8'0" 3'0" x 8'0"	S6568 6 2'8" x 6'8" 2'10" x 6'8" 3'0" x 6'8"	S6536 6 2'8" x 6'8" 2'10" x 6'8" 3'0" x 6'8"	S86536 6 2'8" x 8'0" 2'10" x 8'0" 3'0" x 8'0"	S6565SL 6 12" x 6'8" 14" x 6'8"	S86560SL 6 12" x 8'0" 14" x 8'0"

					
Mahogany		Mahogany		Oak	
FCM1654  2'8" x 6'8" 2'10" x 6'8" 3'0" x 6'8"	FCM81654  2'8" x 8'0" 2'10" x 8'0" 3'0" x 8'0"	FCM1656  2'8" x 6'8" 2'10" x 6'8" 3'0" x 6'8"	FCM1658  2'8" x 6'8" 2'10" x 6'8" 3'0" x 6'8"	FCM1656SL  12" x 6'8" 14" x 6'8"	FCM81654SL  12" x 8'0" 14" x 8'0"
FC1654   2'6" x 6'8" 2'8" x 6'8" (7'0") 2'10" x 6'8" (7'0") 3'0" x 6'8" (7'0")	FC81654  2'8" x 8'0" 2'10" x 8'0" 3'0" x 8'0"	FC81653  2'8" x 8'0" 2'10" x 8'0" 3'0" x 8'0"			





					
Oak	Smooth		Smooth	Smooth	
FC1656SL  12" x 6'8" 14" x 6'8"	FC81654SL  12" x 8'0" 14" x 8'0"	S1654   2'6" x 6'8" 2'8" x 6'8" (7'0") 2'10" x 6'8" (7'0") 3'0" x 6'8" (7'0")	S81654  2'8" x 8'0" 2'10" x 8'0" 3'0" x 8'0"	S1656   2'8" x 6'8" (7'0") 2'10" x 6'8" (7'0") 3'0" x 6'8" (7'0")	S81656   2'8" x 8'0" 2'10" x 8'0" 3'0" x 8'0"
S1658  2'8" x 6'8" 2'10" x 6'8" 3'0" x 6'8"	S1653  2'8" x 6'8" 2'10" x 6'8" 3'0" x 6'8"	S81653  2'8" x 8'0" 2'10" x 8'0" 3'0" x 8'0"	S1656SL  12" x 6'8" 14" x 6'8"	S81654SL  12" x 8'0" 14" x 8'0"	

Frosted Images









							
Mahogany			Mahogany	Mahogany	Oak		
FCM66  2'8" x 6'8" 2'10" x 6'8" 3'0" x 6'8"	FCM6023  2'8" x 6'8" 2'10" x 6'8" 3'0" x 6'8"	FCM6043  2'8" x 6'8" 2'10" x 6'8" 3'0" x 6'8"	FCM66SL  12" x 6'8" 14" x 6'8"	FCM13101SL      10" x 6'8" 12" x 6'8" (7'0") 14" x 6'8" (7'0")	FC66   2'8" x 6'8" (7'0") 2'10" x 6'8" (7'0") 3'0" x 6'8" (7'0")	FC44SL  12" x 6'8" 14" x 6'8"	FC11SL   10" x 6'8" 12" x 6'8" 14" x 6'8"

Frosted Images *Continues on next page.*

Key

-  No Stile Lines
-  Black Nickel Caming (1D)
-  Brushed Nickel Caming (1C)
-  Brass Caming (1A)
-  NEW Scrolled & Flat Advanta Lite Frame
-  Vented Sidelite Options
-  WBDR Options
-  WBDR / HVHZ Options
-  Elevated 10" Bottom Rail Options

Frosted Images Continued

							
Oak	Smooth	Smooth	Smooth	Smooth	Smooth	Smooth	Smooth
13101SL 12" x 6'8" Δ (7'0") 14" x 6'8" Δ (7'0")	S206E 6E 2'8" x 6'8" (7'0") 2'10" x 6'8" (7'0") 3'0" x 6'8" (7'0")	S6023 6E 2'8" x 6'8" (7'0") 2'10" x 6'8" (7'0") 3'0" x 6'8" (7'0")	S6043 6 2'8" x 6'8" 2'10" x 6'8" 3'0" x 6'8"	S34 6 2'8" x 6'8" 2'10" x 6'8" 3'0" x 6'8"	S289ESL 6 12" x 6'8" 14" x 6'8"	S138SL 6 12" x 6'8" 14" x 6'8"	S2070SL 6 10" x 6'8" 12" x 6'8" Δ (7'0") 14" x 6'8" Δ (7'0")

Privacy & Textured Glass with Divided Lites

						
Mahogany	Mahogany	Mahogany	Mahogany	Mahogany	Mahogany	Oak
FCM65_ 2'8" x 6'8" 2'10" x 6'8" 3'0" x 6'8"	FCM6022_ 2'8" x 6'8" 2'10" x 6'8" 3'0" x 6'8"	FCM6042_ 2'8" x 6'8" 2'10" x 6'8" 3'0" x 6'8"	FCM8321_ 2'8" x 8'0" 2'10" x 8'0" 3'0" x 8'0"	FCM65_SL 12" x 6'8" 2'10" x 6'8"	FCM3487_SL 12" x 8'0" 14" x 8'0"	FC65_ E 2'8" x 6'8" (7'0") 2'10" x 6'8" (7'0") 3'0" x 6'8" (7'0")
						
Oak	Oak	Oak	Oak	Smooth	Smooth	Smooth
FC8321_ 2'8" x 8'0" 2'10" x 8'0" 3'0" x 8'0"	FC832_ 2'8" x 8'0" 2'10" x 8'0" 3'0" x 8'0"	FC63_SL 12" x 6'8" 14" x 6'8"	FC3487_SL 12" x 8'0" 14" x 8'0"	S262_ E 2'8" x 6'8" (7'0") 2'10" x 6'8" (7'0") 3'0" x 6'8" (7'0")	S6022_ E 2'8" x 6'8" (7'0") 2'10" x 6'8" (7'0") 3'0" x 6'8" (7'0")	S6042_ 2'8" x 6'8" 2'10" x 6'8" 3'0" x 6'8"

Privacy & Textured Glass Options

Add the code to the blank in the style number for the desired door and glass combination. For details on glass options, see page 139.

XK = Reeded

XG = Geometric

XE = Satin Etch

XC = Chord

XJ = Chinchilla

XR = Rainglass

XN = Granite



Privacy & Textured Glass





Privacy & Textured Glass Continues on next page.

Key

- No Stile Lines
- NEW Scrolled & Flat Advanta Lite Frame
- Simulated Divided Lites (SDL)
- Vented Sidelite Options
- ▲ Flat Lite Frame
- ⊗ WBDL Options
- ⊗ WBDL / HVHZ Options
- E Elevated 10" Bottom Rail Options
- ▲ 6'6" Height Available

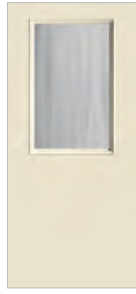
Privacy & Textured Glass *Continued*

		
Smooth	Smooth	Smooth
S104 * 6 E 2'8" x 6'8" (7'0") 2'10" x 6'8" (7'0") 3'0" x 6'8" (7'0")	S30 6 2'8" x 6'8" 2'10" x 6'8" 3'0" x 6'8"	S830 6 2'8" x 8'0" 2'10" x 8'0" 3'0" x 8'0"
	S210_SL 6 12" x 6'8" 14" x 6'8"	S85910_SL 6 12" x 8'0" 14" x 8'0"

Internal Blinds

		
Mahogany	Mahogany	Mahogany
FCM678 * 6 2'8" x 6'8" 2'10" x 6'8" 3'0" x 6'8"	FCM8678 * 6 2'8" x 8'0" 2'10" x 8'0" 3'0" x 8'0"	FCM6035 * 6 2'8" x 6'8" 2'10" x 6'8" 3'0" x 6'8"
		FCM6055 * 6 2'8" x 6'8" 2'10" x 6'8" 3'0" x 6'8"

					
Mahogany	Mahogany	Oak	Oak	Oak	Oak
FCM116 * 6 E 2'6" x 6'8" (7'0") 2'8" x 6'8" (7'0") 2'10" x 6'8" (7'0") 3'0" x 6'8" (7'0")	FCM678SL 6 12" x 6'8" 14" x 6'8"	FCM8678SL 6 12" x 8'0" 14" x 8'0"	FC678 * 6 E 2'6" x 6'8" 2'8" x 6'8" (7'0") 2'10" x 6'8" (7'0") 3'0" x 6'8" (7'0")	FC8678 * 6 2'8" x 8'0" 2'10" x 8'0" 3'0" x 8'0"	FC116 * 6 E 2'6" x 6'8" (7'0") 2'8" x 6'8" (7'0") 2'10" x 6'8" (7'0") 3'0" x 6'8" (7'0")
				FC8971 * 6 2'8" x 8'0" 2'10" x 8'0" 3'0" x 8'0"	FC678SL 6 12" x 6'8" 14" x 6'8"
					FC8678SL 6 12" x 8'0" 14" x 8'0"

					
Smooth	Smooth	Smooth	Smooth	Smooth	Smooth
S132 * 6 E 2'6" x 6'8" 2'8" x 6'8" (7'0") 2'10" x 6'8" (7'0") 3'0" x 6'8" (7'0")	S8132 * 6 2'8" x 8'0" 2'10" x 8'0" 3'0" x 8'0"	S6035 * 6 E 2'8" x 6'8" (7'0") 2'10" x 6'8" (7'0") 3'0" x 6'8" (7'0")	S86035 * 6 E 2'8" x 8'0" 2'10" x 8'0" 3'0" x 8'0"	S6055 * 6 2'8" x 6'8" 2'10" x 6'8" 3'0" x 6'8"	S131 * 6 E 2'6" x 6'8" 2'8" x 6'8" (7'0") 2'10" x 6'8" (7'0") 3'0" x 6'8" (7'0")
				S971 * 6 2'8" x 6'8" 2'10" x 6'8" 3'0" x 6'8"	S8971 * 6 2'8" x 8'0" 2'10" x 8'0" 3'0" x 8'0"
					S132SL * 6 12" x 6'8" 14" x 6'8"
					S8132SL * 6 12" x 8'0" 14" x 8'0"

Privacy & Textured Glass Options

Add the code to the blank in the style number for the desired door and glass combination. For details on glass options, see page 139.

XK = Reeded

XG = Geometric

XE = Satin Etch

XC = Chord

XJ = Chinchilla

XR = Rainglass

XN = Granite

*Features a gliding operation and sash locking system.

Note: See page 299 for important product details that may help with your purchase decision.







Screen Vented Lites*

			
Smooth	Smooth	Smooth	Smooth
S243 E 2'8" x 6'8" (7'0") 2'10" x 6'8" (7'0") 3'0" x 6'8" (7'0")	S6034 E 2'8" x 6'8" (7'0") 2'10" x 6'8" (7'0") 3'0" x 6'8" (7'0")	S6054 2'8" x 6'8" 2'10" x 6'8" 3'0" x 6'8"	S137 E 2'8" x 6'8" (7'0") 2'10" x 6'8" (7'0") 3'0" x 6'8" (7'0")

EnLiten™ Flush-Glazed Clear Glass with Divided Lites

					
Oak	Oak	Oak	Smooth	Smooth	Smooth
FC1350 ▲♦♦♦ 2'6" x 6'8" 2'8" x 6'8" 3'0" x 6'8"	2150 ▲♦♦♦♦♦ 2'6" x 6'8" 2'8" x 6'8" 3'0" x 6'8"	FC1409 ▲♦♦♦♦♦ 2'6" x 6'8" 2'8" x 6'8" 3'0" x 6'8"	S1350 ▲♦♦♦♦♦ 2'6" x 6'8" 2'8" x 6'8" 3'0" x 6'8"	S2150 ▲♦♦♦♦♦ 2'6" x 6'8" 2'8" x 6'8" 3'0" x 6'8"	S1409 ▲♦♦♦♦♦ 2'6" x 6'8" 2'8" x 6'8" 3'0" x 6'8"



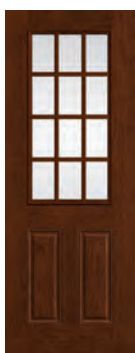



Clear Glass with Divided Lites

						
Mahogany	Mahogany	Mahogany	Mahogany	Mahogany	Mahogany	Mahogany
FCM8322 ★♦♦♦♦♦ 2'8" x 8'0" 2'10" x 8'0" 3'0" x 8'0"	FCM8323 ★♦♦♦♦♦ 2'8" x 8'0" 2'10" x 8'0" 3'0" x 8'0"	FCM8324 ★♦♦♦♦♦ 2'8" x 8'0" 2'10" x 8'0" 3'0" x 8'0"	FCM65 ★♦♦♦♦♦ 2'8" x 8'0" 2'10" x 8'0" 3'0" x 8'0"	FCM6022 ★♦♦♦♦♦ 2'8" x 8'0" 2'10" x 8'0" 3'0" x 8'0"	FCM6042 ★♦♦♦♦♦ 2'8" x 8'0" 2'10" x 8'0" 3'0" x 8'0"	FCM8321 ★♦♦♦♦♦ 2'8" x 8'0" 2'10" x 8'0" 3'0" x 8'0"







Clear Glass with Divided Lites *Continues on next page.*

Key

- No Stile Lines
 1 Simulated Divided Lites (SDLF1)
♦ Flat or Contour Bronze Grilles Between Glass (GBGF / GBGC)
6 WBDR / HVHZ Options
- ▲ Flush-Glazed Glass with Detailed Sticking (FG)
 ♦ Flat or Contour White Grilles Between Glass (GBGF / GBGC)
♦ Flat or Contour Black Grilles Between Glass (GBGF / GBGC)
E Elevated 10" Bottom Rail Options
- ★ Low-E Glass (LE)
 ♦ Flat or Contour Almond Grilles Between Glass (GBGF / GBGC)
6 WBDR Options
- Simulated Divided Lites (SDL)
 6 WBDR Options

							
Mahogany	Mahogany	Mahogany	Mahogany	Mahogany	Mahogany	Mahogany	
FCM8675SL ★♦♦♦ 12" x 8'0" 14" x 8'0"	FCM65SL ★♦♦♦ 12" x 6'8" 14" x 6'8"	FCM7125SL ★♦♦♦ 12" x 8'0" 14" x 8'0"	FCM3487SL ★♦♦♦ 12" x 8'0" 14" x 8'0"	FCM1408 ★♦♦♦ 2'8" x 6'8" 2'10" x 6'8" 3'0" x 6'8"	FCM8145 ★♦♦♦ 2'8" x 8'0" 2'10" x 8'0" 3'0" x 8'0"	FCM1405 ★♦♦♦ 2'8" x 6'8" 2'10" x 6'8" 3'0" x 6'8"	FCM1406 ★♦♦♦ 2'8" x 6'8" 2'10" x 6'8" 3'0" x 6'8"
				FCM1405SL ★♦♦♦ 12" x 6'8" 14" x 6'8"	FCM8145SL ★♦♦♦ 12" x 8'0" 14" x 8'0"		

						
Oak	Oak	Oak	Oak	Oak	Oak	Oak
FC8322 ★♦♦♦ 2'8" x 8'0" 2'10" x 8'0" 3'0" x 8'0"	FC8323 ★♦♦♦ 2'8" x 8'0" 2'10" x 8'0" 3'0" x 8'0"	FC8324 ★♦♦♦ 2'8" x 8'0" 2'10" x 8'0" 3'0" x 8'0"	FC65 ★♦♦♦ 2'6" x 6'8" 2'8" x 6'8" (7'0") 2'10" x 6'8" (7'0") 3'0" x 6'8" (7'0")	FC8321 ★♦♦♦ 2'8" x 8'0" 2'10" x 8'0" 3'0" x 8'0"	FC8318 ★♦♦♦ 2'8" x 8'0" 2'10" x 8'0" 3'0" x 8'0"	FC8319 ★♦♦♦ 2'8" x 8'0" 2'10" x 8'0" 3'0" x 8'0"

						
Oak	Oak	Oak	Oak	Oak	Oak	Oak
FC8320 ★♦♦♦ 2'8" x 8'0" 2'10" x 8'0" 3'0" x 8'0"	FC832 ★♦♦♦ 2'8" x 8'0" 2'10" x 8'0" 3'0" x 8'0"	FC8675SL ★♦♦♦ 12" x 8'0" 14" x 8'0"	FC63SL ★♦♦♦ 12" x 6'8" 14" x 6'8"	FC7125SL ★♦♦♦ 12" x 8'0" 14" x 8'0"	FC3487SL ★♦♦♦ 12" x 8'0" 14" x 8'0"	FC1408 ★♦♦♦ 2'6" x 6'8" 2'8" x 6'8" (7'0") 2'10" x 6'8" (7'0") 3'0" x 6'8" (7'0")
					FC8145 ★♦♦♦ 2'8" x 8'0" 2'10" x 8'0" 3'0" x 8'0"	FC8144 ★♦♦♦ 2'8" x 8'0" 2'10" x 8'0" 3'0" x 8'0"



Oak
 FC1408SL | FC8145SL
 ☀️ ⬆️ ⬆️ ⬆️ ⬆️ | ☀️ ⬆️ ⬆️ ⬆️ ⬆️
 12" x 6'8" | 12" x 8'0"
 14" x 6'8" | 14" x 8'0"

Smooth
 S8322
 ☀️ ⬆️ ⬆️ ⬆️ ⬆️
 2'8" x 8'0"
 2'10" x 8'0"
 3'0" x 8'0"

Smooth
 S8326
 ☀️ ⬆️ ⬆️ ⬆️ ⬆️ E
 2'8" x 8'0"
 2'10" x 8'0"
 3'0" x 8'0"

Smooth
 S8323
 ☀️ ⬆️ ⬆️ ⬆️ ⬆️ 6
 2'8" x 8'0"
 2'10" x 8'0"
 3'0" x 8'0"

Smooth
 S8327
 ☀️ ⬆️ ⬆️ ⬆️ ⬆️ 6 E
 2'8" x 8'0"
 2'10" x 8'0"
 3'0" x 8'0"

Smooth
 S8324
 ☀️ ⬆️ ⬆️ ⬆️ ⬆️
 2'8" x 8'0"
 2'10" x 8'0"
 3'0" x 8'0"

Smooth
 S8328
 ☀️ ⬆️ ⬆️ ⬆️ ⬆️ E
 2'8" x 8'0"
 2'10" x 8'0"
 3'0" x 8'0"

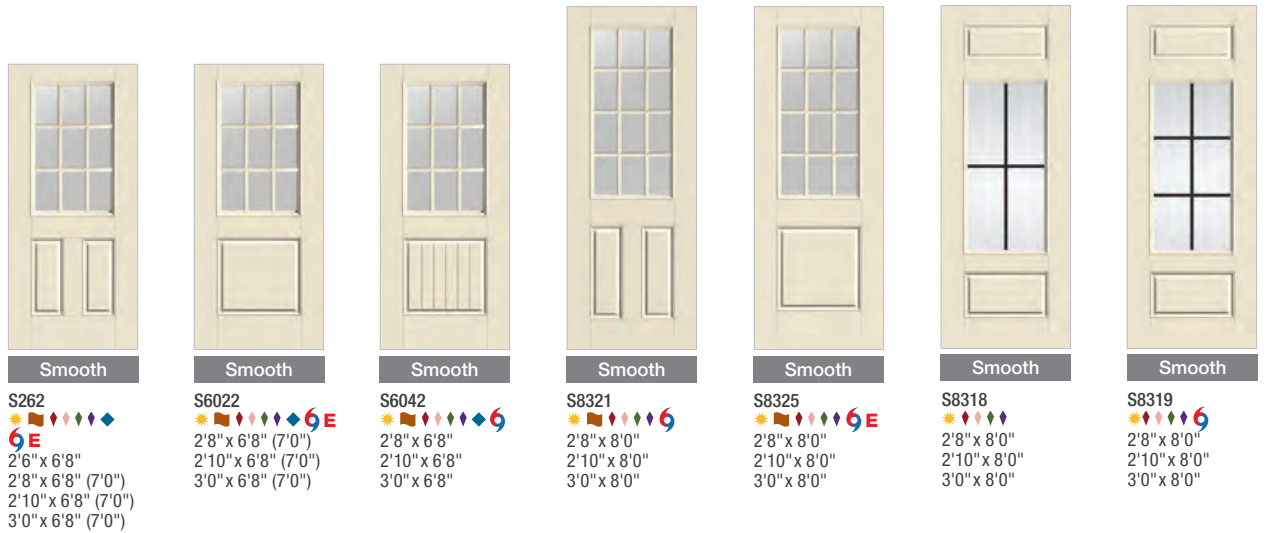

Smooth
 S262
 ☀️ ⬆️ ⬆️ ⬆️ ⬆️
 6 E
 2'6" x 6'8"
 2'8" x 6'8" (7'0")
 2'10" x 6'8" (7'0")
 3'0" x 6'8" (7'0")

Smooth
 S6022
 ☀️ ⬆️ ⬆️ ⬆️ ⬆️ 6 E
 2'8" x 6'8" (7'0")
 2'10" x 6'8" (7'0")
 3'0" x 6'8" (7'0")

Smooth
 S6042
 ☀️ ⬆️ ⬆️ ⬆️ ⬆️ 6
 2'8" x 6'8"
 2'10" x 6'8"
 3'0" x 6'8"

Smooth
 S8321
 ☀️ ⬆️ ⬆️ ⬆️ ⬆️ 6
 2'8" x 8'0"
 2'10" x 8'0"
 3'0" x 8'0"

Smooth
 S8325
 ☀️ ⬆️ ⬆️ ⬆️ ⬆️ 6 E
 2'8" x 8'0"
 2'10" x 8'0"
 3'0" x 8'0"

Smooth
 S8318
 ☀️ ⬆️ ⬆️ ⬆️ ⬆️
 2'8" x 8'0"
 2'10" x 8'0"
 3'0" x 8'0"

Smooth
 S8319
 ☀️ ⬆️ ⬆️ ⬆️ ⬆️ 6
 2'8" x 8'0"
 2'10" x 8'0"
 3'0" x 8'0"

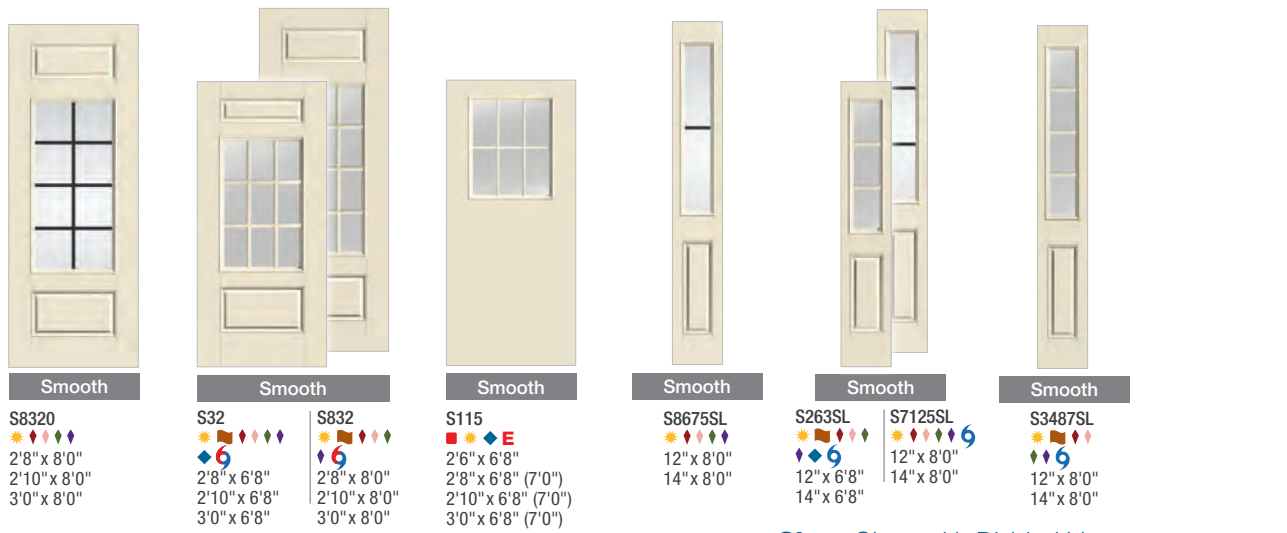

Smooth
 S8320
 ☀️ ⬆️ ⬆️ ⬆️ ⬆️
 2'8" x 8'0"
 2'10" x 8'0"
 3'0" x 8'0"

Smooth
 S32
 ☀️ ⬆️ ⬆️ ⬆️ ⬆️
 6
 2'8" x 6'8"
 2'10" x 6'8"
 3'0" x 6'8"

Smooth
 S832
 ☀️ ⬆️ ⬆️ ⬆️ ⬆️
 6
 2'8" x 8'0"
 2'10" x 8'0"
 3'0" x 8'0"

Smooth
 S115
 ☀️ ⬆️ ⬆️ ⬆️ ⬆️ E
 2'6" x 6'8"
 2'8" x 6'8" (7'0")
 2'10" x 6'8" (7'0")
 3'0" x 6'8" (7'0")

Smooth
 S8675SL
 12" x 8'0"
 14" x 8'0"

Smooth
 S263SL | S7125SL
 ☀️ ⬆️ ⬆️ ⬆️ ⬆️ | ☀️ ⬆️ ⬆️ ⬆️ ⬆️ 6
 12" x 6'8" | 12" x 8'0"
 14" x 6'8" | 14" x 8'0"

Smooth
 S3487SL
 ☀️ ⬆️ ⬆️ ⬆️ ⬆️ 6
 12" x 8'0"
 14" x 8'0"

Clear Glass with Divided Lites *Continues on next page.*

Key

- No Stile Lines
- ☀️ Low-E Glass (LE)
- 🗡️ Simulated Divided Lites (SDL)
- ⬆️ Flat or Contour White Grilles Between Glass (GBGF / GBGC)
- ⬆️ Flat or Contour Almond Grilles Between Glass (GBGF / GBGC)
- ⬆️ Flat or Contour Bronze Grilles Between Glass (GBGF / GBGC)
- ⬆️ Flat or Contour Black Grilles Between Glass (GBGF / GBGC)
- ◆ Fixed Grilles (FXG)
- 6 WBDR Options
- 6 WBDR / HVHZ Options
- E Elevated 10" Bottom Rail Options

Clear Glass with Divided Lites *Continued*



Smooth

S1408
 ★ ◆ ◆ ◆ ◆ **E**
 2'6" x 6'8"
 2'8" x 6'8" (7'0")
 2'10" x 6'8" (7'0")
 3'0" x 6'8" (7'0")



Smooth

S8145
 ★ ◆ ◆ ◆ ◆
 2'8" x 8'0"
 2'10" x 8'0"
 3'0" x 8'0"

S1405
 ★ ◆ ◆ ◆ ◆ **E**
 2'8" x 6'8" (7'0")
 2'10" x 6'8" (7'0")
 3'0" x 6'8" (7'0")

S81405
 ★ ◆ ◆ ◆ ◆ **E**
 2'8" x 8'0"
 2'10" x 8'0"
 3'0" x 8'0"



Smooth

S1406
 ★ ◆ ◆ ◆ ◆
 2'8" x 6'8"
 2'10" x 6'8"
 3'0" x 6'8"



Smooth

S1407
 ★ ◆ ◆ ◆ ◆
 2'8" x 6'8"
 2'10" x 6'8"
 3'0" x 6'8"

S8144
 ★ ◆ ◆ ◆ ◆
 2'8" x 8'0"
 2'10" x 8'0"
 3'0" x 8'0"



Smooth

S1405SL
 ★ ◆ ◆ ◆ ◆
 12" x 6'8"
 14" x 6'8"

S8145SL
 ★ ◆ ◆ ◆ ◆
 12" x 8'0"
 14" x 8'0"

EnLiten™ Flush-Glazed Clear Glass



Oak

2100
 ★ ◆
 2'6" x 6'8"
 2'8" x 6'8"
 3'0" x 6'8"



Smooth

S2100
 ★ ◆
 2'6" x 6'8"
 2'8" x 6'8"
 3'0" x 6'8"



Mahogany

FCM62
 ★ ◆ ◆ ◆ ◆
 2'8" x 6'8"
 2'10" x 6'8"
 3'0" x 6'8"

FCM862
 ★ ◆ ◆ ◆ ◆
 2'8" x 8'0"
 2'10" x 8'0"
 3'0" x 8'0"



Mahogany

FCM6021
 ★ ◆ ◆ ◆ ◆
 2'8" x 6'8"
 2'10" x 6'8"
 3'0" x 6'8"



Mahogany

FCM6041
 ★ ◆ ◆ ◆ ◆
 2'8" x 6'8"
 2'10" x 6'8"
 3'0" x 6'8"



Mahogany

FCM670
 ★ ◆ ◆ ◆ ◆ **E**
 2'6" x 6'8" (7'0")
 2'8" x 6'8" (7'0")
 2'10" x 6'8" (7'0")
 3'0" x 6'8" (7'0")



Mahogany

FCM62SL
 ★ ◆ ◆ ◆ ◆
 12" x 6'8"
 14" x 6'8"

FCM862SL
 ★ ◆ ◆ ◆ ◆
 12" x 8'0"
 14" x 8'0"



Oak

FC62
 ★ ◆ ◆ ◆ ◆ **E**
 2'6" x 6'8"
 2'8" x 6'8" (7'0")
 2'10" x 6'8" (7'0")
 3'0" x 6'8" (7'0")

81929P
 ★ ◆ ◆ ◆ ◆
 2'8" x 8'0"
 2'10" x 8'0"
 3'0" x 8'0"



Oak

FC670
 ★ ◆ ◆ ◆ ◆ **E**
 2'6" x 6'8" (7'0")
 2'8" x 6'8" (7'0")
 2'10" x 6'8" (7'0")
 3'0" x 6'8" (7'0")



Oak

81971P
 ★ ◆ ◆ ◆ ◆
 2'8" x 8'0"
 2'10" x 8'0"
 3'0" x 8'0"



Oak

FC48SL
 ★ ◆ ◆ ◆ ◆
 12" x 6'8"
 14" x 6'8"

81929PSL
 ★ ◆ ◆ ◆ ◆
 12" x 8'0"
 14" x 8'0"



Smooth

S206
 ★ ◆ ◆ ◆ ◆ **E**
 2'6" x 6'8"
 2'8" x 6'8" (7'0")
 2'10" x 6'8" (7'0")
 3'0" x 6'8" (7'0")

S81929P
 ★ ◆ ◆ ◆ ◆
 2'8" x 8'0"
 2'10" x 8'0"
 3'0" x 8'0"

Note: See page 299 for important product details that may help with your purchase decision.



Smooth

S6021

☀️ 6 E

2'8" x 6'8" (7'0")
2'10" x 6'8" (7'0")
3'0" x 6'8" (7'0")

S86021

☀️ 6 E

2'8" x 8'0"
2'10" x 8'0"
3'0" x 8'0"



Smooth

S6041

☀️ 6

2'8" x 6'8"
2'10" x 6'8"
3'0" x 6'8"

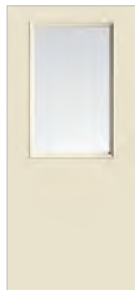

Smooth

S104

☀️ 6 E

2'6" x 6'8"
2'8" x 6'8" (7'0")
2'10" x 6'8" (7'0")
3'0" x 6'8" (7'0")

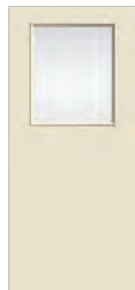

Smooth

S105

☀️ 6 E

2'6" x 6'8"
2'8" x 6'8" (7'0")
2'10" x 6'8" (7'0")
3'0" x 6'8" (7'0")



Smooth

S30

☀️ 6

2'8" x 6'8"
2'10" x 6'8"
3'0" x 6'8"

S830

☀️ 6

2'8" x 8'0"
2'10" x 8'0"
3'0" x 8'0"



Smooth

S210SL

☀️ 6

12" x 6'8"
14" x 6'8"

S85910SL

☀️ 6

12" x 8'0"
14" x 8'0"



Key

■ No Stile Lines

🔥 Flush-Glazed Glass with Detailed Sticking (FG)

☀️ Low-E Glass (LE)

◆ Flat or Contour White Grilles Between Glass (GBGF / GBGC)

◆ Flat or Contour Almond Grilles Between Glass (GBGF / GBGC)

◆ Flat or Contour Bronze Grilles Between Glass (GBGF / GBGC)

◆ Flat or Contour Black Grilles Between Glass (GBGF / GBGC)

6 WBDR Options

6 WBDR / HVHZ Options

E Elevated 10" Bottom Rail Options



Transoms

For transoms, see page 221.



Blackstone® ◆ ◆



Smooth

S6013
2'8" x 6'8"
2'10" x 6'8"
3'0" x 6'8"

Crystalline™ ◆ ◆



Smooth

S930
2'8" x 6'8"
2'10" x 6'8"
3'0" x 6'8"

Sedona ◆ ◆



Smooth

S294
2'8" x 6'8"
2'10" x 6'8"
3'0" x 6'8"

Salinas® x



Smooth

S6014
2'8" x 6'8"
2'10" x 6'8"
3'0" x 6'8"

Maple Park® ◆ ◆



Smooth

S6104
2'8" x 6'8"
2'10" x 6'8"
3'0" x 6'8"

Avonlea® ◆



Smooth

S985
2'8" x 6'8"
2'10" x 6'8"
3'0" x 6'8"

Saratoga™ ◆ ◆



Smooth

S291
2'8" x 6'8"
2'10" x 6'8"
3'0" x 6'8"

Wellesley™ ◆ ◆ ◆



Smooth

S292
2'8" x 6'8"
2'10" x 6'8"
3'0" x 6'8"

Privacy & Textured Glass Options

Add the code to the blank in the style number for the desired door and glass combination. For details on glass options, see page 139.

XK = Reeded

XE = Satin Etch

XJ = Chinchilla

XN = Granite

XG = Geometric

XC = Chord

XR = Rainglass

Note: See page 299 for important product details that may help with your purchase decision.

Top: Smooth-Star, Clear Glass, Door - S289, Finish - Onyx

Riserva® ✕



Smooth

S585
2'8" x 6'8"
2'10" x 6'8"
3'0" x 6'8"

Concorde™ ◆ ◆ ◆ ◆



Smooth

S430
2'8" x 6'8"
2'10" x 6'8"
3'0" x 6'8"

Kensington™ ◆ ◆ ◆ ◆



Smooth

S162
2'8" x 6'8"
2'10" x 6'8"
3'0" x 6'8"

Pembridge™ ◆ ◆ ◆ ◆



Smooth

S6572
2'8" x 6'8"
2'10" x 6'8"
3'0" x 6'8"

Axis◆



Smooth

S1661
2'8" x 6'8"
2'10" x 6'8"
3'0" x 6'8"

Frosted Images®



Smooth

S289E
2'8" x 6'8"
2'10" x 6'8"
3'0" x 6'8"

Privacy & Textured Glass with Divided Lites



Smooth

S807_
2'8" x 6'8"
2'10" x 6'8"
3'0" x 6'8"

Privacy & Textured Glass



Smooth

S289_
2'8" x 6'8"
2'10" x 6'8"
3'0" x 6'8"

Clear Glass with Divided Lites



Smooth

S807
* ◆ ◆ ◆ ◆ ◆
2'8" x 6'8"
2'10" x 6'8"
3'0" x 6'8"



Smooth

S1411
* ◆ ◆ ◆ ◆ ◆
2'8" x 6'8"
2'10" x 6'8"
3'0" x 6'8"

Clear Glass



Smooth

S289
*
2'8" x 6'8"
2'10" x 6'8"
3'0" x 6'8"

Key

- ★ Low-E Glass (LE)
- ◆ Black Nickel Caming (1D)
- ◆ Brushed Nickel Caming (1C)
- ◆ Brass Caming (1A)
- ✕ Wrought Iron (1W)
- ◆ Simulated Divided Lites (SDL)
- ◆ Flat or Contour White Grilles Between Glass (GBGF / GBGC)
- ◆ Flat or Contour Almond Grilles Between Glass (GBGF / GBGC)
- ◆ Flat or Contour Bronze Grilles Between Glass (GBGF / GBGC)
- ◆ Flat or Contour Black Grilles Between Glass (GBGF / GBGC)
- ◆ Fixed Grilles (FXG)



Transoms

For transoms, see page 221.



Blackstone® ◆◆



Mahogany

FCM760
2'8" x 6'8"
2'10" x 6'8"
3'0" x 6'8"



Smooth

S6111
2'8" x 6'8"
2'10" x 6'8"
3'0" x 6'8"

Crystalline™ ◆◆



Mahogany

FCM124
2'8" x 6'8"
2'10" x 6'8"
3'0" x 6'8"



Smooth

S6113
2'8" x 6'8"
2'10" x 6'8"
3'0" x 6'8"

Sedona ◆◆



Mahogany

FCM126
2'8" x 6'8"
2'10" x 6'8"
3'0" x 6'8"



Smooth

S12
2'8" x 6'8"
2'10" x 6'8"
3'0" x 6'8"

Salinas® x



Mahogany

FCM118
2'8" x 6'8"
2'10" x 6'8"
3'0" x 6'8"



Smooth

S6012
2'8" x 6'8"
2'10" x 6'8"
3'0" x 6'8"

Maple Park® ◆◆



Mahogany

FCM904
2'8" x 6'8"
2'10" x 6'8"
3'0" x 6'8"



Smooth

S6105
2'8" x 6'8"
2'10" x 6'8"
3'0" x 6'8"

Avonlea® ◆



Mahogany

FCM800
2'8" x 6'8"
2'10" x 6'8"
3'0" x 6'8"



Smooth

S6121
2'8" x 6'8"
2'10" x 6'8"
3'0" x 6'8"

Note: See page 299 for important product details that may help with your purchase decision.

Top: Smooth-Star, Riserva Glass, Door – S506, Sidelites – S573SL, Finish – Cabernet

Saratoga™ ◆ ◆



Mahogany

FCM909
2'8" x 6'8"
2'10" x 6'8"
3'0" x 6'8"



Smooth

S20
2'8" x 6'8"
2'10" x 6'8"
3'0" x 6'8"

Wellesley™ ◆ ◆ ◆



Mahogany

FCM125
2'8" x 6'8"
2'10" x 6'8"
3'0" x 6'8"



Smooth

S6117
2'8" x 6'8"
2'10" x 6'8"
3'0" x 6'8"

Riserva® X



Mahogany

FCM506
2'8" x 6'8"
2'10" x 6'8"
3'0" x 6'8"



Smooth

S506
2'8" x 6'8"
2'10" x 6'8"
3'0" x 6'8"

Concorde™ ◆ ◆ ◆



Mahogany

FCM914
2'8" x 6'8"
2'10" x 6'8"
3'0" x 6'8"



Smooth

S17
2'8" x 6'8"
2'10" x 6'8"
3'0" x 6'8"

Kensington™ ◆ ◆



Mahogany

FCM150
2'8" x 6'8"
2'10" x 6'8"
3'0" x 6'8"



Smooth

S6119
2'8" x 6'8"
2'10" x 6'8"
3'0" x 6'8"

Pembridge™ ◆ ◆ ◆



Mahogany

FCM6532
2'8" x 6'8"
2'10" x 6'8"
3'0" x 6'8"



Smooth

S6532
2'8" x 6'8"
2'10" x 6'8"
3'0" x 6'8"

Clear Glass



Mahogany

FCM132
★
2'8" x 6'8"
2'10" x 6'8"
3'0" x 6'8"



Smooth

S10
★
2'8" x 6'8"
2'10" x 6'8"
3'0" x 6'8"

Blackstone™ ◆ ◆



Oak

FC80943
6
2'8" x 6'8"
2'10" x 6'8"
3'0" x 6'8"



Oak

FC86243
6
2'8" x 8'0"
2'10" x 8'0"
3'0" x 8'0"



Smooth

S9343
6
2'8" x 6'8"
2'10" x 6'8"
3'0" x 6'8"



Smooth

S83143
6
2'8" x 8'0"
2'10" x 8'0"
3'0" x 8'0"

Key

- ★ Low-E Glass (LE)
- ◆ Black Nickel Caming (1D)
- ◆ Brushed Nickel Caming (1C)
- ◆ Brass Caming (1A)
- X Wrought Iron (1W)
- 6 WBDR / HVHZ Options

Crystalline™ ◆◆



Oak

FC80941
 2'8" x 6'8"
 2'10" x 6'8"
 3'0" x 6'8"



Oak

FC86241
 2'8" x 8'0"
 2'10" x 8'0"
 3'0" x 8'0"



Smooth

S9341
 2'8" x 6'8"
 2'10" x 6'8"
 3'0" x 6'8"



Smooth

S83141
 2'8" x 8'0"
 2'10" x 8'0"
 3'0" x 8'0"

Sedona ◆◆



Oak

FC80952
 2'8" x 6'8"
 2'10" x 6'8"
 3'0" x 6'8"



Oak

FC86252
 2'8" x 8'0"
 2'10" x 8'0"
 3'0" x 8'0"



Smooth

S9352
 2'8" x 6'8"
 2'10" x 6'8"
 3'0" x 6'8"

Salinas® ×



Smooth

S83152
 2'8" x 8'0"
 2'10" x 8'0"
 3'0" x 8'0"



Oak

FC80953
 2'8" x 6'8"
 2'10" x 6'8"
 3'0" x 6'8"



Oak

FC86253
 2'8" x 8'0"
 2'10" x 8'0"
 3'0" x 8'0"



Smooth

S9353
 2'8" x 6'8"
 2'10" x 6'8"
 3'0" x 6'8"



Smooth

S83153
 2'8" x 8'0"
 2'10" x 8'0"
 3'0" x 8'0"

Maple Park◆◆



Oak

FC80955
 2'8" x 6'8"
 2'10" x 6'8"
 3'0" x 6'8"



Oak

FC86255
 2'8" x 8'0"
 2'10" x 8'0"
 3'0" x 8'0"

Avonlea◆



Smooth

S9355
 2'8" x 6'8"
 2'10" x 6'8"
 3'0" x 6'8"



Smooth

S83155
 2'8" x 8'0"
 2'10" x 8'0"
 3'0" x 8'0"



Oak

FC80956
 2'8" x 6'8"
 2'10" x 6'8"
 3'0" x 6'8"



Oak

FC86256
 2'8" x 8'0"
 2'10" x 8'0"
 3'0" x 8'0"



Smooth

S9356
 2'8" x 6'8"
 2'10" x 6'8"
 3'0" x 6'8"



Smooth

S83156
 2'8" x 8'0"
 2'10" x 8'0"
 3'0" x 8'0"

Saratoga™ ◆ ◆



Oak
FC80954
6
2'8" x 6'8"
2'10" x 6'8"
3'0" x 6'8"

Oak
FC86254
6
2'8" x 8'0"
2'10" x 8'0"
3'0" x 8'0"

Smooth
S9354
6
2'8" x 6'8"
2'10" x 6'8"
3'0" x 6'8"

Smooth
S83154
6
2'8" x 8'0"
2'10" x 8'0"
3'0" x 8'0"

Wellesley™ ◆ ◆ ◆



Oak
FC80949
6
2'8" x 6'8"
2'10" x 6'8"
3'0" x 6'8"

Oak
FC86249
6
2'8" x 8'0"
2'10" x 8'0"
3'0" x 8'0"

Smooth
S9349
6
2'8" x 6'8"
2'10" x 6'8"
3'0" x 6'8"

Riserva ×



Smooth
S83149
6
2'8" x 8'0"
2'10" x 8'0"
3'0" x 8'0"

Oak
FC507
6
2'8" x 6'8"
2'10" x 6'8"
3'0" x 6'8"

Oak
FC549
6
2'8" x 8'0"
2'10" x 8'0"
3'0" x 8'0"

Smooth
S507
6
2'8" x 6'8"
2'10" x 6'8"
3'0" x 6'8"

Smooth
S549
6
2'8" x 8'0"
2'10" x 8'0"
3'0" x 8'0"

Concorde™ ◆ ◆ ◆



Oak
FC80947
6
2'8" x 6'8"
2'10" x 6'8"
3'0" x 6'8"

Oak
FC86247
6
2'8" x 8'0"
2'10" x 8'0"
3'0" x 8'0"

Kensington™ ◆ ◆



Smooth
S9347
6
2'8" x 6'8"
2'10" x 6'8"
3'0" x 6'8"

Smooth
S83147
6
2'8" x 8'0"
2'10" x 8'0"
3'0" x 8'0"

Oak
FC80942
6
2'8" x 6'8"
2'10" x 6'8"
3'0" x 6'8"

Oak
FC86242
6
2'8" x 8'0"
2'10" x 8'0"
3'0" x 8'0"

Smooth
S9342
6
2'8" x 6'8"
2'10" x 6'8"
3'0" x 6'8"

Smooth
S83142
6
2'8" x 8'0"
2'10" x 8'0"
3'0" x 8'0"

Key

- ◆ Black Nickel Caming (1D)
- ◆ ◆ Brushed Nickel Caming (1C)
- ◆ ◆ ◆ Brass Caming (1A)
- × Wrought Iron (1W)

6 WBDR / HVHZ Options

Pembridge™ ◆ ◆ ◆ ◆

			
Oak	Oak	Smooth	Smooth
FC6534 6 2'8" x 6'8" 2'10" x 6'8" 3'0" x 6'8"	FC86533 6 2'8" x 8'0" 2'10" x 8'0" 3'0" x 8'0"	S6534 6 2'8" x 6'8" 2'10" x 6'8" 3'0" x 6'8"	S86533 6 2'8" x 8'0" 2'10" x 8'0" 3'0" x 8'0"

Axis® ◆

		
Oak	Oak	Smooth
FC1655 6 2'8" x 6'8" 2'10" x 6'8" 3'0" x 6'8"	FC81649 6 2'8" x 8'0" 2'10" x 8'0" 3'0" x 8'0"	S1655 6 2'8" x 6'8" 2'10" x 6'8" 3'0" x 6'8"

Frosted Images®

				
Smooth	Oak	Oak	Smooth	Smooth
S81649 6 2'8" x 8'0" 2'10" x 8'0" 3'0" x 8'0"	FC80945 6 2'8" x 6'8" 2'10" x 6'8" 3'0" x 6'8"	FC86245 6 2'8" x 8'0" 2'10" x 8'0" 3'0" x 8'0"	S9345 6 2'8" x 6'8" 2'10" x 6'8" 3'0" x 6'8"	S83145 6 2'8" x 8'0" 2'10" x 8'0" 3'0" x 8'0"

Privacy & Textured
Glass with Divided Lites

	
Oak	Oak
FC809203_ 6 2'8" x 6'8" 2'10" x 6'8" 3'0" x 6'8"	FC862203_ 6 2'8" x 8'0" 2'10" x 8'0" 3'0" x 8'0"

Privacy & Textured Glass

					
Smooth	Smooth	Oak	Oak	Smooth	Smooth
S93203_ 6 2'8" x 6'8" 2'10" x 6'8" 3'0" x 6'8"	S831203_ 6 2'8" x 8'0" 2'10" x 8'0" 3'0" x 8'0"	FC80920_ 6 2'8" x 6'8" 2'10" x 6'8" 3'0" x 6'8"	FC86220_ 6 2'8" x 8'0" 2'10" x 8'0" 3'0" x 8'0"	S9320_ 6 2'8" x 6'8" 2'10" x 6'8" 3'0" x 6'8"	S83120_ 6 2'8" x 8'0" 2'10" x 8'0" 3'0" x 8'0"

Privacy & Textured Glass Options

Add the code to the blank in the style number for the desired door and glass combination. For details on glass options, see page 139.

XK = Reeded

XE = Satin Etch

XJ = Chinchilla

XN = Granite

XG = Geometric

XC = Chord

XR = Rainglass

Internal Blinds



Oak

FC925

☀️ 6
2'8" x 6'8"
2'10" x 6'8"
3'0" x 6'8"



Oak

FC8972

☀️ 6
2'8" x 8'0"
2'10" x 8'0"
3'0" x 8'0"



Smooth

S925

☀️ 6
2'8" x 6'8"
2'10" x 6'8"
3'0" x 6'8"



Smooth

S8972

☀️ 6
2'8" x 8'0"
2'10" x 8'0"
3'0" x 8'0"

Clear Glass with Divided Lites



Oak

FC809203

☀️ 🏠 🍷 6
2'8" x 6'8"
2'10" x 6'8"
3'0" x 6'8"



Oak

FC862203

☀️ 🏠 🍷 6
2'8" x 8'0"
2'10" x 8'0"
3'0" x 8'0"



Smooth

S93203

☀️ 🏠 🍷 6
2'8" x 6'8"
2'10" x 6'8"
3'0" x 6'8"



Smooth

S831203

☀️ 🏠 🍷 6
2'8" x 8'0"
2'10" x 8'0"
3'0" x 8'0"



Oak

FC1404

☀️ 🍷 6
2'8" x 6'8"
2'10" x 6'8"
3'0" x 6'8"



Oak

FC8141

☀️ 🍷 6
2'8" x 8'0"
2'10" x 8'0"
3'0" x 8'0"



Smooth

S1404

☀️ 🍷 6
2'8" x 6'8"
2'10" x 6'8"
3'0" x 6'8"



Smooth

S8141

☀️ 🍷 6
2'8" x 8'0"
2'10" x 8'0"
3'0" x 8'0"

Clear Glass



Oak

FC80920

☀️ 6
2'8" x 6'8"
2'10" x 6'8"
3'0" x 6'8"



Oak

FC86220

☀️ 6
2'8" x 8'0"
2'10" x 8'0"
3'0" x 8'0"



Smooth

S9320

☀️ 6
2'8" x 6'8"
2'10" x 6'8"
3'0" x 6'8"



Smooth

S83120

☀️ 6
2'8" x 8'0"
2'10" x 8'0"
3'0" x 8'0"

Key

☀️ Low-E Glass (LE)

🏠 Black Nickel Caming (1D)

🏠 Brushed Nickel Caming (1C)

🏠 Brass Caming (1A)

🏠 Simulated Divided Lites (SDL)

🍷 Flat or Contour White Grilles
Between Glass (GBGF / GBGC)

🍷 Flat or Contour Almond Grilles
Between Glass (GBGF / GBGC)

🍷 Flat or Contour Bronze Grilles
Between Glass (GBGF / GBGC)

🍷 Flat or Contour Black Grilles
Between Glass (GBGF / GBGC)

🍷 Fixed Grilles (FXG)

🍷 WBDP / HVHZ Options



Transoms

For transoms, see page 221.

Optional Dentil Shelves***

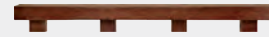

4-Block Dentil Shelf

Available for all Craftsman-style Fiber-Classic Mahogany Collection doors.



4-Block Dentil Shelf

Available for all Craftsman-style Smooth-Star doors.

Sedona ◆◆



Smooth

S2650*
 E
 2'8" x 6'8"
 2'10" x 6'8"
 3'0" x 6'8"



Mahogany

FCM604

 2'8" x 6'8"
 2'10" x 6'8"
 3'0" x 6'8"



Smooth

S604 S8604

 2'8" x 6'8" 2'8" x 8'0"
 2'10" x 6'8" 2'10" x 8'0"
 3'0" x 6'8" 3'0" x 8'0"

Maple Park ◆◆



Smooth

S2630**
 E
 2'8" x 6'8"
 2'10" x 6'8"
 3'0" x 6'8"



Mahogany

S82630**

 2'8" x 8'0"
 2'10" x 8'0"
 3'0" x 8'0"

FCM609

 2'8" x 6'8"
 2'10" x 6'8"
 3'0" x 6'8"

EnLiten™ Flush-Glazed Saratoga™ ◆◆



Smooth

S609 S8609

 2'8" x 6'8" 2'8" x 8'0"
 2'10" x 6'8" 2'10" x 8'0"
 3'0" x 6'8" 3'0" x 8'0"



Mahogany

FCM6240

 2'8" x 6'8"
 2'10" x 6'8"
 3'0" x 6'8"



Mahogany

FCM6201SL

 12" x 6'8"
 14" x 6'8"



Smooth

S6240 S86240

 2'8" x 6'8" (7'0") 2'8" x 8'0"
 2'10" x 6'8" (7'0") 2'10" x 8'0"
 3'0" x 6'8" (7'0") 3'0" x 8'0"



Smooth

S6201SL S86201SL

 10" x 6'8" 12" x 8'0"
 12" x 6'8" (7'0") 14" x 8'0"
 14" x 6'8" (7'0")



Smooth

S6240SL S86240SL

 12" x 6'8" 12" x 8'0"
 14" x 6'8" 14" x 8'0"

Privacy & Textured Glass Options

Add the code to the blank in the style number for the desired door and glass combination. For details on glass options, see page 139.

XE = Satin Etch
 XC = Chord

XJ = Chinchilla
 XR = Rainglass

XN = Granite

*Available with flat lite frame or Advanta flat lite frame only.

**Available with flat lite frame, Advanta flat lite frame or Impact-rated lite frame only.

***Not recommended for use behind storm doors or to be painted dark colors, if exposed to direct sunlight.

Note: See page 299 for important product details that may help with your purchase decision.

Saratoga™ ◆ ◆



Mahogany

FCM602

2'8" x 6'8"
2'10" x 6'8"
3'0" x 6'8"

Smooth

S2660**

2'8" x 6'8"
2'10" x 6'8"
3'0" x 6'8"

Smooth

S82660**

2'8" x 8'0"
2'10" x 8'0"
3'0" x 8'0"

Smooth

S602

2'8" x 6'8"
2'10" x 6'8"
3'0" x 6'8"

Smooth

S8602

2'8" x 8'0"
2'10" x 8'0"
3'0" x 8'0"

Riserva® ✕



Mahogany

FCM508

2'8" x 6'8"
2'10" x 6'8"
3'0" x 6'8"

Smooth

S2670**

2'8" x 6'8"
2'10" x 6'8"
3'0" x 6'8"

Smooth

S82670**

2'8" x 8'0"
2'10" x 8'0"
3'0" x 8'0"

Pembridge™ ◆ ◆ ◆



Smooth

S508

2'8" x 6'8"
2'10" x 6'8"
3'0" x 6'8"

S8508

2'8" x 8'0"
2'10" x 8'0"
3'0" x 8'0"

Mahogany

FCM6520

2'8" x 6'8"
2'10" x 6'8"
3'0" x 6'8"

Smooth

S2640**

2'8" x 6'8"
2'10" x 6'8"
3'0" x 6'8"

Smooth

S82640**

2'8" x 8'0"
2'10" x 8'0"
3'0" x 8'0"

Smooth

S6520

2'8" x 6'8"
2'10" x 6'8"
3'0" x 6'8"

S86520

2'8" x 8'0"
2'10" x 8'0"
3'0" x 8'0"

Mahogany

FCM1650

2'8" x 6'8"
2'10" x 6'8"
3'0" x 6'8"

Axis® ◆



Smooth

S2620**

2'8" x 6'8"
2'10" x 6'8"
3'0" x 6'8"

S82620**

2'8" x 8'0"
2'10" x 8'0"
3'0" x 8'0"

Smooth

S1650

2'8" x 6'8"
2'10" x 6'8"
3'0" x 6'8"

S81650

2'8" x 8'0"
2'10" x 8'0"
3'0" x 8'0"

EnLiten™ Flush-Glazed Privacy & Textured Glass with Divided Lites



Mahogany

FCM4812_

2'8" x 6'8"
2'10" x 6'8"
3'0" x 6'8"

Mahogany

FCM4813_

2'8" x 6'8"
2'10" x 6'8"
3'0" x 6'8"

Mahogany

FCM4814_

2'8" x 6'8"
2'10" x 6'8"
3'0" x 6'8"

EnLiten Flush-Glazed Privacy & Textured Glass with Divided Lites *Continues on next page.*

Key





- 🔥 Flush-Glazed Glass with Detailed Sticking (FG)
- 💧 Flush-Glazed Glass with Square Sticking (FG)
- ◆ Black Nickel Caming (1D)

- ◆ Brushed Nickel Caming (1C)
- ◆ Brass Caming (1A)
- ✕ Wrought Iron (1W)
- 🔲 Simulated Divided Lites (SDLF1)



- ▭ Flat Lite Frame
- 🔲 NEW Scrolled & Flat Advanta Lite Frame
- 🔲 NEW Flat Advanta Lite Frame





- 🔲 WBDR Options
- 🔲 WBDR / HVH Options
- 🔲 Elevated 10" Bottom Rail Options





EnLiten™ Flush-Glazed Privacy & Textured Glass with Divided Lites *Continued*

							
Mahogany	Mahogany	Smooth	Smooth	Smooth			
FCM4816_* ▲ ■ E 2'8" x 6'8" 2'10" x 6'8" 3'0" x 6'8"	FCM2050_SL ▲ ■ ● 12" x 6'8" 14" x 6'8"	S4812_* ▲ ■ E 2'8" x 6'8" (7'0") 2'10" x 6'8" (7'0") 3'0" x 6'8" (7'0")	S84812_* ▲ ■ 2'8" x 8'0" 2'10" x 8'0" 3'0" x 8'0"	S4813_* ▲ ■ E 2'8" x 6'8" (7'0") 2'10" x 6'8" (7'0") 3'0" x 6'8" (7'0")	S84813_* ▲ ■ 2'8" x 8'0" 2'10" x 8'0" 3'0" x 8'0"	S4814_* ▲ ■ E 2'8" x 6'8" (7'0") 2'10" x 6'8" (7'0") 3'0" x 6'8" (7'0")	S84814_* ▲ ■ 2'8" x 8'0" 2'10" x 8'0" 3'0" x 8'0"

Privacy & Textured Glass with Divided Lites

			
Smooth	Smooth		
S4816_* ▲ ■ E 2'8" x 6'8" (7'0") 2'10" x 6'8" (7'0") 3'0" x 6'8" (7'0")	S84816_* ▲ ■ 2'8" x 8'0" 2'10" x 8'0" 3'0" x 8'0"	S4812_SL_* ▲ ■ 12" x 6'8" 14" x 6'8"	S84812_SL_* ▲ ■ 12" x 8'0" 14" x 8'0"

			
Mahogany	Mahogany	Mahogany	Mahogany
FCM605_* ▲ ■ 2'8" x 6'8" 2'10" x 6'8" 3'0" x 6'8"	FCM606_* ▲ ■ 2'8" x 6'8" 2'10" x 6'8" 3'0" x 6'8"	FCM607_* ▲ ■ 2'8" x 6'8" 2'10" x 6'8" 3'0" x 6'8"	FCM608_* ▲ ■ 2'8" x 6'8" 2'10" x 6'8" 3'0" x 6'8"

							
Smooth	Smooth	Smooth	Smooth				
S605_* ▲ ■ 2'8" x 6'8" 2'10" x 6'8" 3'0" x 6'8"	S8605_* ▲ ■ 2'8" x 8'0" 2'10" x 8'0" 3'0" x 8'0"	S606_* ▲ ■ 2'8" x 6'8" 2'10" x 6'8" 3'0" x 6'8"	S8606_* ▲ ■ 2'8" x 8'0" 2'10" x 8'0" 3'0" x 8'0"	S607_* ▲ ■ 2'8" x 6'8" 2'10" x 6'8" 3'0" x 6'8"	S8607_* ▲ ■ 2'8" x 8'0" 2'10" x 8'0" 3'0" x 8'0"	S608_* ▲ ■ 2'8" x 6'8" 2'10" x 6'8" 3'0" x 6'8"	S8608_* ▲ ■ 2'8" x 8'0" 2'10" x 8'0" 3'0" x 8'0"

Privacy & Textured Glass Options

Add the code to the blank in the style number for the desired door and glass combination. For details on glass options, see page 139.

XK = Reeded XE = Satin Etch XJ = Chinchilla XN = Granite
XG = Geometric XC = Chord XR = Rainglass

*Not available with Reeded (XK) or Geometric (XG) glass.

**Available with flat lite frame, Advanta flat lite frame or Impact-rated lite frame only.

Note: See page 299 for important product details that may help with your purchase decision.

EnLiten™ Flush-Glazed Privacy & Textured Glass



Mahogany

FCM4810_*
▲ E
2'8" x 6'8"
2'10" x 6'8"
3'0" x 6'8"



Mahogany

FCM2000_SL
▲ ●
12" x 6'8"
14" x 6'8"



Smooth

S4810_*
▲ E
2'8" x 6'8" (7'0")
2'10" x 6'8" (7'0")
3'0" x 6'8" (7'0")



Smooth

S84810_* S4810_SL* S84810_SL*
▲ ▲ ▲
2'8" x 8'0" 12" x 6'8" 12" x 8'0"
2'10" x 8'0" 14" x 6'8" 14" x 8'0"
3'0" x 8'0"

Privacy & Textured Glass



Mahogany

FCM601_*
▲ ●
2'8" x 6'8"
2'10" x 6'8"
3'0" x 6'8"



Smooth

S2610_* S82610_*
▲ ● E ▲ ● E
2'8" x 6'8" 2'8" x 8'0"
2'10" x 6'8" 2'10" x 8'0"
3'0" x 6'8" 3'0" x 8'0"

Fiber-Classic® & Smooth-Star®

EnLiten™ Flush-Glazed Clear Glass with Divided Lites



Smooth

S601_* S8600_*
▲ ● ▲ ●
2'8" x 6'8" 2'8" x 8'0"
2'10" x 6'8" 2'10" x 8'0"
3'0" x 6'8" 3'0" x 8'0"



Mahogany

FCM4812
▲ ● E
2'8" x 6'8"
2'10" x 6'8"
3'0" x 6'8"



Mahogany

FCM4813
▲ ● E
2'8" x 6'8"
2'10" x 6'8"
3'0" x 6'8"



Mahogany

FCM4814
▲ ● E
2'8" x 6'8"
2'10" x 6'8"
3'0" x 6'8"



Mahogany

FCM4816
▲ ● E
2'8" x 6'8"
2'10" x 6'8"
3'0" x 6'8"



Mahogany

FCM2050SL
▲ ● E
12" x 6'8"
14" x 6'8"



Smooth

S4812 S84812
▲ ● E ▲ ● E
2'8" x 6'8" (7'0") 2'8" x 8'0"
2'10" x 6'8" (7'0") 2'10" x 8'0"
3'0" x 6'8" (7'0") 3'0" x 8'0"



Smooth

S4813 S84813
▲ ● E ▲ ● E
2'8" x 6'8" (7'0") 2'8" x 8'0"
2'10" x 6'8" (7'0") 2'10" x 8'0"
3'0" x 6'8" (7'0") 3'0" x 8'0"



Smooth

S4814 S84814
▲ ● E ▲ ● E
2'8" x 6'8" (7'0") 2'8" x 8'0"
2'10" x 6'8" (7'0") 2'10" x 8'0"
3'0" x 6'8" (7'0") 3'0" x 8'0"



Smooth

S4816 S84816
▲ ● E ▲ ● E
2'8" x 6'8" (7'0") 2'8" x 8'0"
2'10" x 6'8" (7'0") 2'10" x 8'0"
3'0" x 6'8" (7'0") 3'0" x 8'0"



Smooth

S4812SL S84812SL
▲ ● E ▲ ● E
12" x 6'8" 12" x 8'0"
14" x 6'8" 14" x 8'0"

Key

- ▲ Flush-Glazed Glass with Detailed Sticking (FG)
- ▲ Flush-Glazed Glass with Square Sticking (FG)
- ▲ Low-E Glass (LE)

- ▲ Simulated Divided Lites (SDL)
- ▲ Simulated Divided Lites (SDFL1)
- ▲ Flat or Contour White Grilles Between Glass (GBGF / GBGC)
- ▲ Flat or Contour Almond Grilles Between Glass (GBGF / GBGC)

- ▲ Flat or Contour Bronze Grilles Between Glass (GBGF / GBGC)
- ▲ Flat Lite Frame**
- ▲ NEW Scrolled & Flat Advanta Lite Frame

- ▲ NEW Flat Advanta Lite Frame**
- ▲ NEW Scrolled Advanta Lite Frame
- ▲ Vented Sidelite Options

- ▲ WBDL Options
- ▲ WBDL / HVHZ Options
- ▲ Elevated 10" Bottom Rail Options

Clear Glass with Divided Lites



Mahogany

FCM605
 * 🗨️ 🗨️
 2'8" x 6'8"
 2'10" x 6'8"
 3'0" x 6'8"



Mahogany

FCM606
 * 🗨️ 🗨️
 2'8" x 6'8"
 2'10" x 6'8"
 3'0" x 6'8"



Mahogany

FCM607
 * 🗨️ 🗨️
 2'8" x 6'8"
 2'10" x 6'8"
 3'0" x 6'8"



Mahogany

FCM608
 * 🗨️ 🗨️
 2'8" x 6'8"
 2'10" x 6'8"
 3'0" x 6'8"



Smooth

S605
 * 🗨️ 🗨️
 2'8" x 6'8"
 2'10" x 6'8"
 3'0" x 6'8"

S8605
 * 🗨️ 🗨️
 2'8" x 8'0"
 2'10" x 8'0"
 3'0" x 8'0"



Smooth

S606
 * 🗨️ 🗨️
 2'8" x 6'8"
 2'10" x 6'8"
 3'0" x 6'8"

S8606
 * 🗨️ 🗨️
 2'8" x 8'0"
 2'10" x 8'0"
 3'0" x 8'0"



Smooth

S607
 * 🗨️ 🗨️
 2'8" x 6'8"
 2'10" x 6'8"
 3'0" x 6'8"

S8607
 * 🗨️ 🗨️
 2'8" x 8'0"
 2'10" x 8'0"
 3'0" x 8'0"



Smooth

S608
 * 🗨️ 🗨️
 2'8" x 6'8"
 2'10" x 6'8"
 3'0" x 6'8"

S8608
 * 🗨️ 🗨️
 2'8" x 8'0"
 2'10" x 8'0"
 3'0" x 8'0"

EnLiten™ Flush-Glazed Clear Glass



Mahogany

FCM4810
 🗨️ 🗨️ E
 2'8" x 6'8"
 2'10" x 6'8"
 3'0" x 6'8"



Mahogany

FCM2000SL
 🗨️ 🗨️
 12" x 6'8"
 14" x 6'8"



Smooth

S4810
 🗨️ 🗨️ E
 2'8" x 6'8" (7'0")
 2'10" x 6'8" (7'0")
 3'0" x 6'8" (7'0")

S84810
 🗨️ 🗨️
 2'8" x 8'0"
 2'10" x 8'0"
 3'0" x 8'0"



Smooth

S4810SL
 🗨️ 🗨️
 12" x 6'8"
 14" x 6'8"

S84810SL
 🗨️ 🗨️
 12" x 8'0"
 14" x 8'0"

Clear Glass



Mahogany

FCM601
 * 🗨️ 🗨️
 2'8" x 6'8"
 2'10" x 6'8"
 3'0" x 6'8"



Smooth

S2610*
 * 🗨️ 🗨️ E
 2'8" x 6'8"
 2'10" x 6'8"
 3'0" x 6'8"

S82610*
 * 🗨️ 🗨️
 2'8" x 8'0"
 2'10" x 8'0"
 3'0" x 8'0"



Smooth

S601
 * 🗨️ 🗨️
 2'8" x 6'8"
 2'10" x 6'8"
 3'0" x 6'8"

S8601
 * 🗨️ 🗨️
 2'8" x 8'0"
 2'10" x 8'0"
 3'0" x 8'0"

*Available with flat lite frame, Advanta flat lite frame or Impact-rated lite frame only.
 Note: See page 299 for important product details that may help with your purchase decision.



Transoms

For transoms, see page 221.

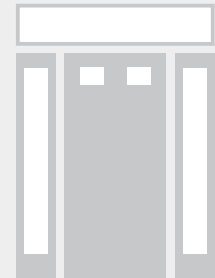

Maple Park[®] ◆◆



Mahogany

FCM736	FCM8736
2'8" x 6'8"	2'8" x 8'0"
2'10" x 6'8"	2'10" x 8'0"
3'0" x 6'8"	3'0" x 8'0"



Oak

FC736	FC8736
2'8" x 6'8" (7'0")	2'8" x 8'0"
2'10" x 6'8" (7'0")	2'10" x 8'0"
3'0" x 6'8" (7'0")	3'0" x 8'0"



Smooth

S736	S8736
E 2'8" x 6'8" (7'0")	2'8" x 8'0"
2'10" x 6'8" (7'0")	2'10" x 8'0"
3'0" x 6'8" (7'0")	3'0" x 8'0"

Saratoga[™] ◆◆



Mahogany

FCM707	FCM8707
2'8" x 6'8"	2'8" x 8'0"
2'10" x 6'8"	2'10" x 8'0"
3'0" x 6'8"	3'0" x 8'0"



Oak

FC707	FC8707
2'8" x 6'8" (7'0")	2'8" x 8'0"
2'10" x 6'8" (7'0")	2'10" x 8'0"
3'0" x 6'8" (7'0")	3'0" x 8'0"

Wellesley[™] ◆◆◆



Smooth

S707	S8707
E 2'8" x 6'8" (7'0")	2'8" x 8'0"
2'10" x 6'8" (7'0")	2'10" x 8'0"
3'0" x 6'8" (7'0")	3'0" x 8'0"



Mahogany

FCM721	FCM8721
2'8" x 6'8"	2'8" x 8'0"
2'10" x 6'8"	2'10" x 8'0"
3'0" x 6'8"	3'0" x 8'0"



Oak

FC721	FC8721
2'8" x 6'8" (7'0")	2'8" x 8'0"
2'10" x 6'8" (7'0")	2'10" x 8'0"
3'0" x 6'8" (7'0")	3'0" x 8'0"



Smooth

S721	S8721
E 2'8" x 6'8" (7'0")	2'8" x 8'0"
2'10" x 6'8" (7'0")	2'10" x 8'0"
3'0" x 6'8" (7'0")	3'0" x 8'0"

Key

- Flush-Glazed Glass with Detailed Sticking (FG)
- Flush-Glazed Glass with Square Sticking (FG)
- Low-E Glass (LE)

- Black Nickel Caming (1D)
- Brushed Nickel Caming (1C)
- Brass Caming (1A)
- Simulated Divided Lites (SDL)

- Flat Lite Frame
- NEW Scrolled & Flat Advanta Lite Frame
- NEW Scrolled Advanta Lite Frame

- NEW Flat Advanta Lite Frame
- Vented Sidelite Options
- WBDR Options

- WBDR / HVHZ Options
- Elevated 10" Bottom Rail Options

Concorde™ ◆ ◆ ◆



Mahogany

FCM735	FCM8735
2'8" x 6'8"	2'8" x 8'0"
2'10" x 6'8"	2'10" x 8'0"
3'0" x 6'8"	3'0" x 8'0"



Oak

FC735	FC8735
2'8" x 6'8" (7'0")	2'8" x 8'0"
2'10" x 6'8" (7'0")	2'10" x 8'0"
3'0" x 6'8" (7'0")	3'0" x 8'0"



Smooth

S735	S8735
E	2'8" x 8'0"
2'8" x 6'8" (7'0")	2'10" x 8'0"
2'10" x 6'8" (7'0")	3'0" x 8'0"
3'0" x 6'8" (7'0")	

Pembridge™ ◆ ◆ ◆



Mahogany

FCM745	FCM8745
2'8" x 6'8"	2'8" x 8'0"
2'10" x 6'8"	2'10" x 8'0"
3'0" x 6'8"	3'0" x 8'0"



Oak

FC745	FC8745
2'8" x 6'8" (7'0")	2'8" x 8'0"
2'10" x 6'8" (7'0")	2'10" x 8'0"
3'0" x 6'8" (7'0")	3'0" x 8'0"

Clear Glass with Divided Lites



Smooth

S745	S8745
E	2'8" x 8'0"
2'8" x 6'8" (7'0")	2'10" x 8'0"
2'10" x 6'8" (7'0")	3'0" x 8'0"
3'0" x 6'8" (7'0")	



Mahogany

FCM752	FCM8752
★ ◆ ◆ ◆ ◆	★ ◆ ◆ ◆ ◆
2'8" x 6'8"	2'8" x 8'0"
2'10" x 6'8"	2'10" x 8'0"
3'0" x 6'8"	3'0" x 8'0"



Oak

FC752	FC8752
★ ◆ ◆ ◆ ◆	★ ◆ ◆ ◆ ◆
2'8" x 6'8" (7'0")	2'8" x 8'0"
2'10" x 6'8" (7'0")	2'10" x 8'0"
3'0" x 6'8" (7'0")	3'0" x 8'0"



Smooth

S752	S8752
★ ◆ ◆ ◆ ◆ E	★ ◆ ◆ ◆ ◆
2'8" x 6'8" (7'0")	2'8" x 8'0"
2'10" x 6'8" (7'0")	2'10" x 8'0"
3'0" x 6'8" (7'0")	3'0" x 8'0"



Mahogany

FCM704	FCM8704
★ ◆	★ ◆
2'8" x 6'8"	2'8" x 8'0"
2'10" x 6'8"	2'10" x 8'0"
3'0" x 6'8"	3'0" x 8'0"

Clear Glass



Oak

FC704	FC8704
★ ◆	★ ◆
2'8" x 6'8" (7'0")	2'8" x 8'0"
2'10" x 6'8" (7'0")	2'10" x 8'0"
3'0" x 6'8" (7'0")	3'0" x 8'0"



Smooth

S704	S8704
★ ◆ E	★ ◆
2'8" x 6'8" (7'0")	2'8" x 8'0"
2'10" x 6'8" (7'0")	2'10" x 8'0"
3'0" x 6'8" (7'0")	3'0" x 8'0"



Mahogany

FCM708	FCM8708
★	★
2'8" x 6'8"	2'8" x 8'0"
2'10" x 6'8"	2'10" x 8'0"
3'0" x 6'8"	3'0" x 8'0"



Oak

FC708	FC8708
★	★
2'8" x 6'8" (7'0")	2'8" x 8'0"
2'10" x 6'8" (7'0")	2'10" x 8'0"
3'0" x 6'8" (7'0")	3'0" x 8'0"



Smooth

S708	S8708
★ E	★
2'8" x 6'8" (7'0")	2'8" x 8'0"
2'10" x 6'8" (7'0")	2'10" x 8'0"
3'0" x 6'8" (7'0")	3'0" x 8'0"

Crystalline™ ♦ ❑ ❑ ❑



Oak

FC21
2'8" x 6'8"
2'10" x 6'8"
3'0" x 6'8"



Smooth

S6123
2'8" x 6'8"
2'10" x 6'8"
3'0" x 6'8"

Concorde™ ♦ ❑ ❑ ❑



Oak

FC917
2'8" x 6'8"
2'10" x 6'8"
3'0" x 6'8"



Smooth

S454
2'8" x 6'8"
2'10" x 6'8"
3'0" x 6'8"

Clear Glass with Divided Lites



Oak

FC23
* ⬆ ⬆ ⬆ ♦
2'8" x 6'8"
2'10" x 6'8"
3'0" x 6'8"



Smooth

S255
* ⬆ ⬆ ⬆ ♦
2'8" x 6'8"
2'10" x 6'8"
3'0" x 6'8"

Clear Glass



Oak

FC803
*
2'8" x 6'8"
2'10" x 6'8"
3'0" x 6'8"



Smooth

S256
*
2'8" x 6'8"
2'10" x 6'8"
3'0" x 6'8"

Clear Glass with Divided Lites



Smooth

S236
♦
2'8" x 6'8"
2'10" x 6'8"
3'0" x 6'8"

S8317
♦
2'8" x 8'0"
2'10" x 8'0"
3'0" x 8'0"



Smooth

S237
* ♦
2'8" x 6'8"
2'10" x 6'8"
3'0" x 6'8"
(Scalloped Lite Frame)

Pembridge™ ♦ ❑ ❑ ❑



Mahogany

FCM6570
2'8" x 6'8"
2'10" x 6'8"
3'0" x 6'8"

FCM86570
2'8" x 8'0"
2'10" x 8'0"
3'0" x 8'0"

Axis™ ♦



Oak

FC6570
E
2'6" x 6'8" (7'0")
2'8" x 6'8" (7'0")
2'10" x 6'8" (7'0")
3'0" x 6'8" (7'0")



Smooth

S6570
E
2'6" x 6'8"
2'8" x 6'8" (7'0")
2'10" x 6'8" (7'0")
3'0" x 6'8" (7'0")

S86570
2'6" x 8'0"
2'8" x 8'0"
2'10" x 8'0"
3'0" x 8'0"



Mahogany

FCM1645
2'8" x 6'8"
2'10" x 6'8"
3'0" x 6'8"

FCM81645
2'8" x 8'0"
2'10" x 8'0"
3'0" x 8'0"



Oak

FC1645
E
2'6" x 6'8" (7'0")
2'8" x 6'8" (7'0")
2'10" x 6'8" (7'0")
3'0" x 6'8" (7'0")



Smooth

S1645
E
2'6" x 6'8"
2'8" x 6'8" (7'0")
2'10" x 6'8" (7'0")
3'0" x 6'8" (7'0")

S81645
2'6" x 8'0"
2'8" x 8'0"
2'10" x 8'0"
3'0" x 8'0"

Key

- Low-E Glass (LE)
- Black Nickel Caming (1D)
- Brushed Nickel Caming (1C)
- Brass Caming (1A)
- Flat or Contour White Grilles Between Glass (GBGF / GBGC)
- Flat or Contour Bronze Grilles Between Glass (GBGF / GBGC)
- Flat or Contour Almond Grilles Between Glass (GBGF / GBGC)
- Fixed Grilles (FXG)
- Elevated 10" Bottom Rail Options

Privacy & Textured Glass



Mahogany

FCM61_	FCM861_
2'8" x 6'8"	2'8" x 8'0"
2'10" x 6'8"	2'10" x 8'0"
3'0" x 6'8"	3'0" x 8'0"



Oak

FC61_	FC861_
2'6" x 6'8" (7'0")	2'8" x 8'0"
2'8" x 6'8" (7'0")	2'10" x 8'0"
2'10" x 6'8" (7'0")	3'0" x 8'0"
3'0" x 6'8" (7'0")	



Smooth

S296_	S896_
2'6" x 6'8"	2'6" x 8'0"
2'8" x 6'8" (7'0")	2'8" x 8'0"
2'10" x 6'8" (7'0")	2'10" x 8'0"
3'0" x 6'8" (7'0")	3'0" x 8'0"

Clear Glass



Mahogany

FCM61	FCM861
2'8" x 6'8"	2'8" x 8'0"
2'10" x 6'8"	2'10" x 8'0"
3'0" x 6'8"	3'0" x 8'0"



Oak

FC61	FC861
2'6" x 6'8" (7'0")	2'8" x 8'0"
2'8" x 6'8" (7'0")	2'10" x 8'0"
2'10" x 6'8" (7'0")	3'0" x 8'0"
3'0" x 6'8" (7'0")	



Smooth

S296	S896
2'6" x 6'8"	2'6" x 8'0"
2'8" x 6'8" (7'0")	2'8" x 8'0"
2'10" x 6'8" (7'0")	2'10" x 8'0"
3'0" x 6'8" (7'0")	3'0" x 8'0"



Noise Reduction Doors

Therma-Tru® Noise Reduction doors deliver aesthetics with a commercial level of performance for residential projects. Ideal for multi-use and urban in-fill projects located near sources of noise pollution, our Noise Reduction doors provide a Sound Transmission Class (STC) rating of 36. Our Noise Reduction lites also offer added security from forced entry with laminated glass surrounded by a standard Lip-lite frame.

Note: Also available in decorative full-lite glass option in aluminum Lip-lite frame.



Smooth

S140STC	S8140STC
2'6" x 6'8" (7'0")	2'6" x 8'0"
2'8" x 6'8" (7'0")	2'8" x 8'0"
2'10" x 6'8" (7'0")	2'10" x 8'0"
3'0" x 6'8" (7'0")	3'0" x 8'0"



Smooth

S141STC
2'6" x 6'8" (7'0")
2'8" x 6'8" (7'0")
2'10" x 6'8" (7'0")
3'0" x 6'8" (7'0")



Smooth

S6063STC
2'6" x 6'8" (7'0")
2'8" x 6'8" (7'0")
2'10" x 6'8" (7'0")
3'0" x 6'8" (7'0")

Privacy & Textured Glass Options

Add the code to the blank in the style number for the desired door and glass combination. For details on glass options, see page 139.

XK = Reeded
XG = Geometric

XE = Satin Etch
XC = Chord

XJ = Chinchilla
XR = Rainglass

XN = Granite

Note: See page 299 for important product details that may help with your purchase decision.

Top: Smooth-Star, Clear Glass, Door – S296, Finish – Cypress

Right Page: Smooth-Star Door – S1100, Sidelites – S2000SL, Finish – Granite



Transoms

For transoms, see page 221.

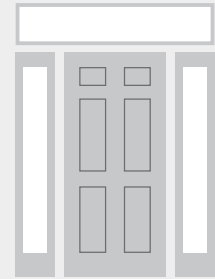

Mahogany	Mahogany	Mahogany	Mahogany	Mahogany	Mahogany	Mahogany	Mahogany
FCM31	FCM220	FCM205	FCM755	FCM600	FCM134	FCM60	FCM860
6 2'8" x 6'8" 2'10" x 6'8" 3'0" x 6'8"	6 2'8" x 6'8" 2'10" x 6'8" 3'0" x 6'8"	6 2'8" x 6'8" 2'10" x 6'8" 3'0" x 6'8"	6 2'8" x 6'8" 2'10" x 6'8" 3'0" x 6'8"	6 2'8" x 6'8" 2'10" x 6'8" 3'0" x 6'8"	6 2'8" x 6'8" 2'10" x 6'8" 3'0" x 6'8"	6 2'8" x 6'8" 2'10" x 6'8" 3'0" x 6'8"	6 2'8" x 8'0" 2'10" x 8'0" 3'0" x 8'0"



Mahogany	Oak	Oak	Oak	Oak	Oak	Oak	
FCM1000	FCM81000	FC31	FC809	FC755	FC862	FC60	FC860
6 E 2'0" x 6'8" 2'4" x 6'8" 2'6" x 6'8" (7'0") 2'8" x 6'8" (7'0") 2'10" x 6'8" (7'0") 3'0" x 6'8" (7'0")	6 2'0" x 8'0" 2'4" x 8'0" 2'6" x 8'0" 2'8" x 8'0" 2'10" x 8'0" 3'0" x 8'0"	6 2'8" x 6'8" 2'10" x 6'8" 3'0" x 6'8"	6 2'8" x 6'8" 2'10" x 6'8" 3'0" x 6'8"	6 2'8" x 6'8" 2'10" x 6'8" 3'0" x 6'8"	6 2'8" x 8'0" 2'10" x 8'0" 3'0" x 8'0"	6 E 2'6" x 6'8" (7'0") 2'8" x 6'8" (7'0") 2'10" x 6'8" (7'0") 3'0" x 6'8" (7'0")	6 2'8" x 8'0" 2'10" x 8'0" 3'0" x 8'0"

Key

- No Stile Lines
- ☀ Low-E Glass (LE)
- ◆ Flat White Grilles Between Glass Only (GBGFW)
- 6 WBDR Options
- 6 WBDR / HVHZ Options
- E Elevated 10" Bottom Rail Options



Oak

- | | |
|----------------------------|----------------------------|
| 1000
■ 6E | 81000
■ 6 |
| 2'0" x 6'8" | 2'0" x 8'0" |
| 2'4" x 6'8" Δ | 2'4" x 8'0" |
| 2'6" x 6'8" Δ (7'0") | 2'6" x 8'0" |
| 2'8" x 6'8" Δ (7'0") | 2'8" x 8'0" |
| 2'10" x 6'8" Δ (7'0") | 2'10" x 8'0" |
| 3'0" x 6'8" Δ (7'0") | 3'0" x 8'0" |



Smooth

- | |
|------------------------|
| S93
6 |
| 2'8" x 6'8" |
| 2'10" x 6'8" |
| 3'0" x 6'8" |



Smooth

- | | |
|--------------------------|---------------------------|
| S220
6E | S8200
6E |
| 2'8" x 6'8" (7'0") | 2'8" x 8'0" |
| 2'10" x 6'8" (7'0") | 2'10" x 8'0" |
| 3'0" x 6'8" (7'0") | 3'0" x 8'0" |



Smooth

- | | |
|---------------------------|---------------------------|
| S1100
6E | S81100
6 |
| 2'8" x 6'8" | 2'8" x 8'0" |
| 2'10" x 6'8" | 2'10" x 8'0" |
| 3'0" x 6'8" | 3'0" x 8'0" |



Smooth

- | | |
|--------------------------|--------------------------|
| S120
6E | S8120
6 |
| 2'8" x 6'8" | 2'8" x 8'0" |
| 2'10" x 6'8" | 2'10" x 8'0" |
| 3'0" x 6'8" | 3'0" x 8'0" |



Smooth

- | | |
|-------------------------|-------------------------|
| S200
6 | S897
6 |
| 2'6" x 6'8" | 2'8" x 8'0" |
| 2'8" x 6'8" | 2'10" x 8'0" |
| 2'10" x 6'8" | 3'0" x 8'0" |
| 3'0" x 6'8" | |



Smooth

- | | |
|-------------------------|--------------------------|
| S205
6 | S8201
6 |
| 2'8" x 6'8" | 2'8" x 8'0" |
| 2'10" x 6'8" | 2'10" x 8'0" |
| 3'0" x 6'8" | 3'0" x 8'0" |



Smooth

- | |
|-------------------------|
| S755
6 |
| 2'8" x 6'8" |
| 2'10" x 6'8" |
| 3'0" x 6'8" |



Smooth

- | | |
|------------------------|-------------------------|
| S31
6 | S831
6 |
| 2'8" x 6'8" | 2'8" x 8'0" |
| 2'10" x 6'8" | 2'10" x 8'0" |
| 3'0" x 6'8" | 3'0" x 8'0" |



Smooth

- | |
|-------------------------|
| S960
6 |
| 2'8" x 6'8" |
| 2'10" x 6'8" |
| 3'0" x 6'8" |



Smooth

- | | |
|---------------------------|---------------------------|
| S4800
6E | S84800
6 |
| 2'8" x 6'8" | 2'8" x 8'0" |
| 2'10" x 6'8" | 2'10" x 8'0" |
| 3'0" x 6'8" | 3'0" x 8'0" |



Smooth

- | | |
|-------------------------|--------------------------|
| S600
6 | S8600
6 |
| 2'8" x 6'8" | 2'8" x 8'0" |
| 2'10" x 6'8" | 2'10" x 8'0" |
| 3'0" x 6'8" | 3'0" x 8'0" |



Smooth

- | |
|------------------------|
| S11
6 |
| 2'8" x 6'8" |
| 2'10" x 6'8" |
| 3'0" x 6'8" |



Smooth

- | | |
|--------------------------|-------------------------|
| S210
6E | S810
6 |
| 2'6" x 6'8" | 2'6" x 8'0" |
| 2'8" x 6'8" (7'0") | 2'8" x 8'0" |
| 2'10" x 6'8" (7'0") | 2'10" x 8'0" |
| 3'0" x 6'8" (7'0") | 3'0" x 8'0" |

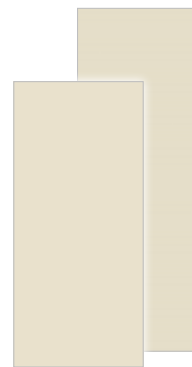

Smooth

- | | |
|----------------------------|-----------------------------|
| S100
■ 6E | S81000
■ 6 |
| 2'0" x 6'8" Δ | 2'0" x 8'0" |
| 2'4" x 6'8" Δ | 2'4" x 8'0" |
| 2'6" x 6'8" Δ | 2'6" x 8'0" |
| 2'8" x 6'8" Δ (7'0") | 2'8" x 8'0" |
| 2'10" x 6'8" Δ (7'0") | 2'10" x 8'0" |
| 3'0" x 6'8" Δ (7'0") | 3'0" x 8'0" |
| 3'6" x 6'8" | 3'6" x 8'0" |

Transoms

Transoms can be stained or painted to match a Fiber-Classic or Smooth-Star door system.

Blackstone



BSRT
3'0" door + (2) 12" sidelites
Continuous Sill Systems Only

Crystalline



19080T
3'0" door + (2) 12" sidelites
Continuous Sill Systems Only
3'0" door + (2) 14" sidelites
Continuous / Boxed Sill Systems



19820T
3'0" door + (2) 12" sidelites
3'0" door + (2) 14" sidelites
Continuous / Boxed Sill Systems



19800T
3'0" Door Only



19810T
12" & 14" Sidelite Only

Sedona



19055T
3'0" door + (2) 12" sidelites
3'0" door + (2) 14" sidelites
Continuous Sill Systems Only



19520T
3'0" door + (2) 12" sidelites
3'0" door + (2) 14" sidelites
Continuous Sill Systems Only

Salinas



SART
3'0" door + (2) 12" sidelites
Continuous Sill Systems Only

Maple Park



FWRT
3'0" door + (2) 12" sidelites
3'0" door + (2) 14" sidelites
Continuous Sill Systems Only

Avonlea



AVRT
3'0" door + (2) 12" sidelites
3'0" door + (2) 14" sidelites
Continuous Sill Systems Only

Saratoga



19750T
3'0" door + (2) 12" sidelites
Continuous Sill Systems Only



19740T
3'0" Door Only

Wellesley



19730T
3'0" door + (2) 12" sidelites
Continuous Sill Systems Only



19720T
3'0" Door Only

Riserva



RSRT
3'0" door + (2) 12" sidelites
Continuous Sill Systems Only

Concorde



CNRT
3'0" door + (2) 12" sidelites
3'0" door + (2) 14" sidelites
Continuous Sill Systems Only

Kensington



KNRT
3'0" door + (2) 12" sidelites
3'0" door + (2) 14" sidelites
Continuous Sill Systems Only

Pembridge



PBRT
3'0" door + (2) 12" sidelites
3'0" door + (2) 14" sidelites
Continuous / Boxed Sill Systems

Axis



AXRT
3'0" door + (2) 12" sidelites
3'0" door + (2) 14" sidelites
Continuous / Boxed Sill Systems

Clear Glass



Grille Sticks Applied



19020T
*
3'0" door + (2) 12" sidelites
Continuous Sill Systems Only
3'0" door + (2) 14" sidelites
Continuous / Boxed Sill Systems



Grille Sticks Applied



19220T
*
3'0" door + (2) 12" sidelites
3'0" door + (2) 14" sidelites
Continuous / Boxed Sill Systems



Grille Sticks Applied

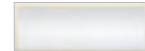

19200T
*
3'0" Door Only



19210T
*
12" & 14" Sidelite Only

Key

- No Stile Lines
- ★ Low-E Glass (LE)
- ◆ Black Nickel Caming (1D)
- ⦿ Brushed Nickel Caming (1C)
- ❖ Brass Caming (1A)
- ✕ Wrought Iron (1W)
- 6 WBDR Options
- 6 WBDR / HVHZ Options
- ⤴ 6'6" Height Available
- E Elevated 10" Bottom Rail Options

Hinged Patio Doors

Fiber-Classic®, Smooth-Star®, Profiles™ & Traditions

Hinged Patio Doors



Flexible options for any home.

Our Fiber-Classic, Smooth-Star, Profiles and Traditions product lines extend to the patio with a wide assortment of options that combine form and function. Explore convenient options to control natural light and privacy, complement window grid patterns and more, all backed by Therma-Tru's outstanding warranties.



Note: Finish colors may vary from an actual application due to fluctuations in finishing or printing. See your Therma-Tru seller or visit www.thermatru.com for details on limited warranties and exclusions, and ENERGY STAR qualified products.

Top: Smooth-Star, Internal Blinds, Doors – S2600
Bottom: Smooth-Star, Clear Glass, Doors – S118

Door Selections



Fiber-Classic[®]
Mahogany
Collection™

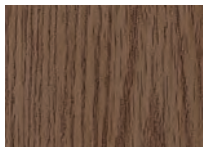

Fiber-Classic[®]
Oak Collection™



Smooth-Star[®]



Profiles™ & Traditions

(Wood-grained images shown in Driftwood stain.)

Retractable Screen Doors

With a discreet, hidden design, retractable screen doors allow fresh air and natural light inside while keeping debris and insects out. Available for single and french inswing configurations. See pages 42–43 for details.

Glass Selections



Internal Blinds



Low-E / Clear

Divided Lites

For details on divided lite options, see pages 140–141.



Simulated
Divided
Lites



Grilles
Between
Glass



Fixed
Grilles

Flush-Glazed Glass

Glass built directly into the door during the manufacturing process offers a seamless appearance, wider daylight opening and high-performance weather seal.

EnLiten™ Flush-Glazed Warranty Riders

See page 33 for details on the EnLiten™ Flush-Glazed Rider for Construction & Installation, and the EnLiten™ Flush-Glazed Rider for Homeowners.

■ = Available	Fiber-Classic.	Smooth-Star.	Profiles.	Traditions
Door Selections				
Material	Fiberglass	Fiberglass	Steel	Steel
Warranty	Lifetime	Lifetime	10 Years	Door: 5 Years Glass: 10 Years
Finish Options	Stain or Paint	Paint	Paint	Paint
Flush-Glazed Glass Selections				
Internal Blinds ◆	■	■		
Low-E Glass with and without Divided Lites ▲	■	■		
Clear Glass with and without Divided Lites ▲	■	■		
Privacy & Textured Glass with and without Divided Lites ▲	■	■		
Lip-Lite Glass Selections				
Internal Blinds	■	■	■	■
Low-E Glass with and without Divided Lites	■	■	■	■
Clear Glass with and without Divided Lites	■	■	■	■
Privacy & Textured Glass with and without Divided Lites	■	■	■	■
Available Sizes				
Heights	6'6", 6'8", 7'0", 8'0"	6'6", 6'8", 7'0", 8'0"	6'6", 6'8", 7'0"	6'6", 6'8", 8'0"
Single Widths	2'0"–3'0"	2'0"–3'0"	2'0"–3'0"	2'0"–3'0"
Double Widths	4'0"–6'0"	4'0"–6'0"	4'0"–6'0"	4'0"–6'0"
Triple Widths	6'0"–9'0"	6'0"–9'0"	6'0"–9'0"	6'0"–9'0"
Retrofit Openings	5'0", 6'0"	5'0", 6'0"	5'0", 6'0"	5'0", 6'0"
Additional Options				
Vented Sidelites (Single / Double Widths)	6'6", 6'8", 8'0" Heights in 2'4"–6'0" Widths	6'6", 6'8", 8'0" Heights in 2'4"–6'0" Widths		
Screens & Screen Accessories Available Colors: Bronze, White	2" Frame, 3" Frame	2" Frame, 3" Frame	2" Frame, 3" Frame	2" Frame, 3" Frame
Impact-Rated Options	■	■	■	■
Tru-Defense Eligible	■	■		

EnLiten™ Flush-Glazed Internal Blinds



Available Collections

- Smooth-Star®

Available Door Styles



Available Configurations

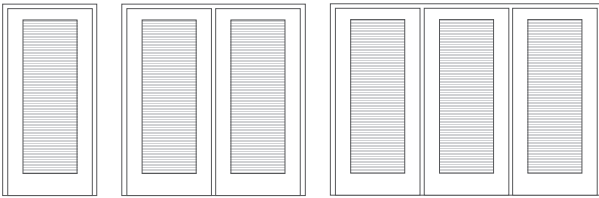

Internal Blinds



Available Collections

- Fiber-Classic® Mahogany
- Fiber-Classic® Oak
- Smooth-Star®
- Profiles™
- Traditions

Available Door Styles



Available Configurations

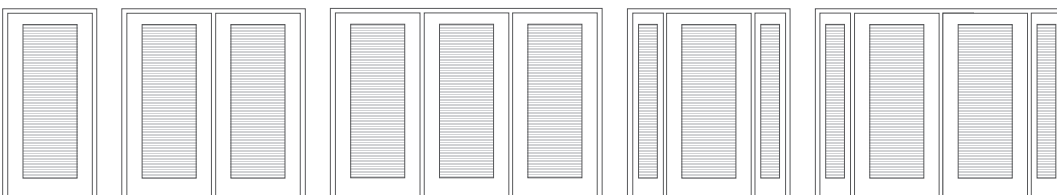

Colonial Style



Available Collections

- Fiber-Classic® Oak
- Smooth-Star®

Available Door Styles

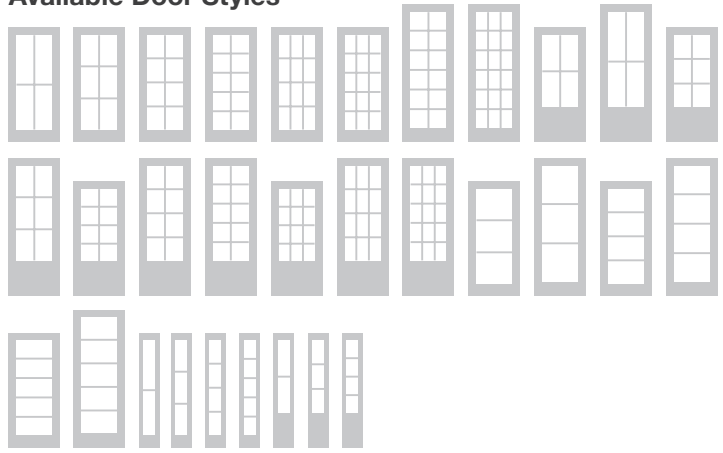

Available Configurations

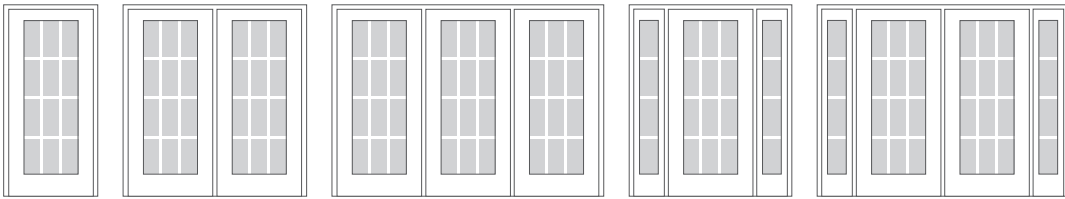

Prairie Style



Available Collections

- Fiber-Classic® Oak
- Smooth-Star®

Available Door Styles



Available Configurations

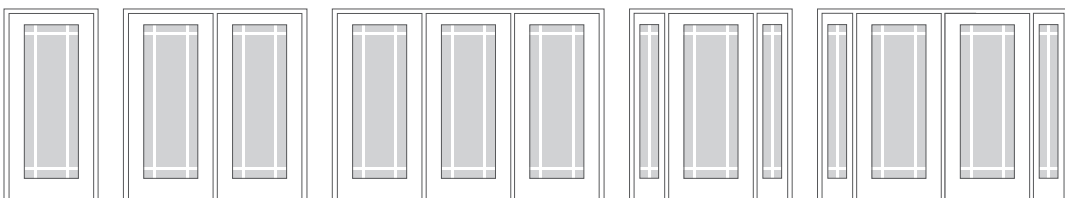

EnLiten™ Flush-Glazed Low-E / Clear Glass

Hinged Patio Doors



Available Collections

- Fiber-Classic. Oak
- Smooth-Star.

Available Door Styles

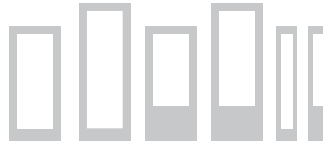

Available Configurations

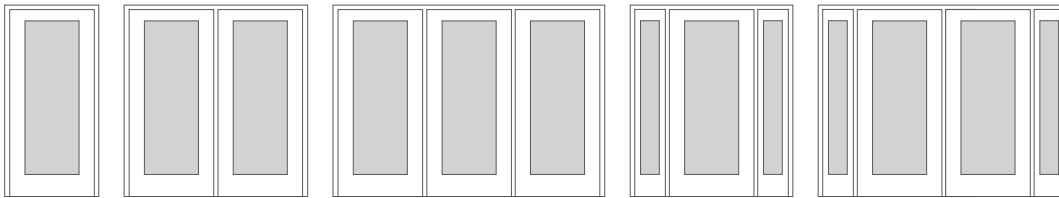

Low-E / Clear Glass with Divided Lites

Colonial Style



Available Collections

- Fiber-Classic. Mahogany
- Fiber-Classic. Oak
- Smooth-Star.
- Profiles.
- Traditions

Available Door Styles



Available Configurations

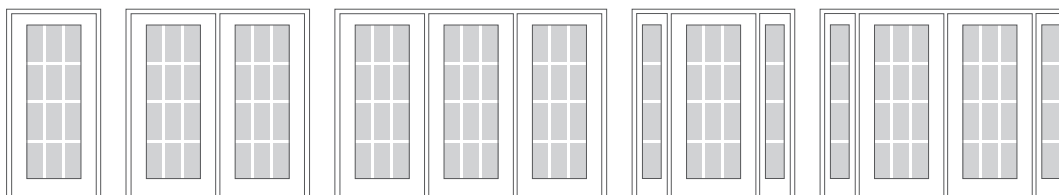

Prairie Style



Available Collections

- Fiber-Classic® Mahogany
- Fiber-Classic® Oak
- Smooth-Star®
- Profiles™
- Traditions

Available Door Styles

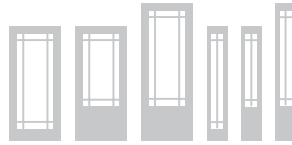

Available Configurations

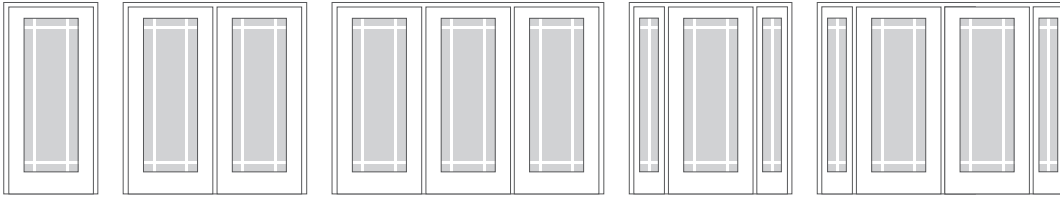

Low-E / Clear Glass



Available Collections

- Fiber-Classic® Mahogany
- Fiber-Classic® Oak
- Smooth-Star®
- Profiles™
- Traditions

Available Door Styles



Available Configurations

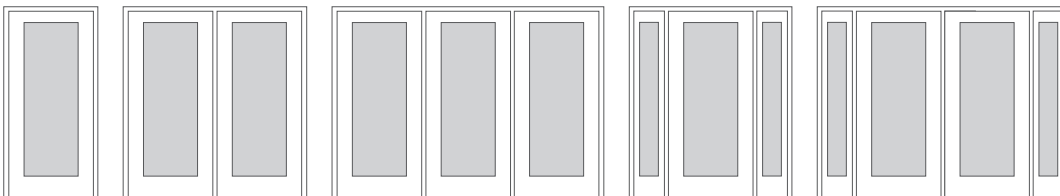

Profiles™ Steel Doors



Versatile, affordable options.

Coupling distinctive styling with affordability, Profiles steel doors offer versatile front entry and house-to-garage options. Designed to suit multiple home styles, these doors feature triple-shadowed panel embossments for greater detail.

Top: Profiles, Sedona Glass, Door – 996HD, Sidelite – 139SL
Bottom: Profiles, Screen Vented Glass, Door – 1004HD

Traditions Steel Doors



Back to basics.

It's back to basics with Traditions. This line of steel doors combines attractive designs and value-based options to create a great, cost-conscious alternative for front entry and house-to-garage.

Top: Traditions Door – TS210
Bottom: Traditions, Satin Etch Glass, Doors – TS289XE



Profiles™ & Traditions Steel Doors

Find style at an affordable price point with options to match any home style and budget in Profiles and Traditions doors. Fire-rated options on 6'8" solid-panel doors make a perfect choice for house-to-garage.

- 1-¼" lock stiles.
- 12-½" lock blocks.
- No stile lines.
- Primed, ready-to-paint surface.

 WBDR / HVHZ Options: Look for this icon to find door styles that can be configured for WBDR or HVHZ.*

 20-Minute Fire-rated options available on 6'8" solid-panel doors. See pages 254–259.



Profiles™ Steel

Features 24-gauge steel, smooth surface and triple-shadowed panel embossments for greater definition.



Traditions Steel

Features 25-gauge steel, standard embossed smooth surface. All 8'0" doors are 24-gauge steel with standard embossments.



■ = Available	Profiles™	Traditions
• = Not Applicable		
P = Paint		

Door Widths

2'0"	■	■
2'4"	■	■
2'6"	■	■
2'8"	■	■
2'10"	■	■
3'0"	■	■
3'6"	■	•

Door Heights

6'6"	■	■
6'8"	■	■
7'0"	■	•
8'0"	•	■

Glass Options

Decorative	15	15
Privacy & Textured	7	7
Internal Blinds	■	■
Screen Vented Lites	■	■
Simulated Divided Lites	■	■
Grilles Between Glass	■	■
Fixed Grilles	■	■
Low-E	■	■
Clear	■	■

Additional Options

Finish	P	P
--------	---	---

Retrofit Hinged Patio Doors

Replacing common slider sizes? Find hinged patio door options on pages 222–227.

5'0" Patio Opening = (2) 2'4" Doors
6'0" Patio Opening = (2) 2'10" Doors

*Please verify that there is a Therma-Tru Impact-rated product approval for the configuration before buying.

**Decorative glass designs are shown in Profiles only.

***Brass coming not available for Impact.

Note: Finish colors may vary from an actual application due to fluctuations in finishing or printing. Glass privacy ratings may be more or less than indicated, based on glass design and size of glass. Glass designs may differ from depiction due to size and hand craftsmanship of glass. See your Therma-Tru seller or visit www.thermatru.com for details on glass privacy ratings and designs, limited warranties and exclusions, ENERGY STAR qualified products and product approvals.

Decorative & Specialty Glass Designs**



Black Nickel
Brushed Nickel
Blackstone
Glass Privacy Rating: 7



Black Nickel
Brushed Nickel
Crystalline
Glass Privacy Rating: 7

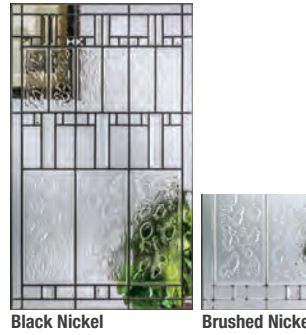

Black Nickel
Brushed Nickel
Sedona
Glass Privacy Rating: 7



Wrought Iron
Salinas
Glass Privacy Rating: 10

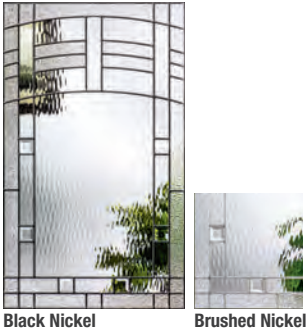

Black Nickel
Brushed Nickel
Maple Park
Glass Privacy Rating: 6

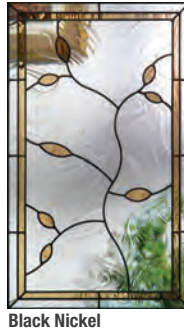

Black Nickel
Avonlea
Glass Privacy Rating: 4

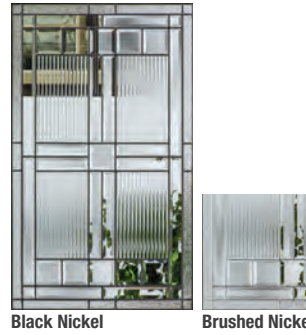

Black Nickel
Brushed Nickel
Saratoga
Glass Privacy Rating: 7

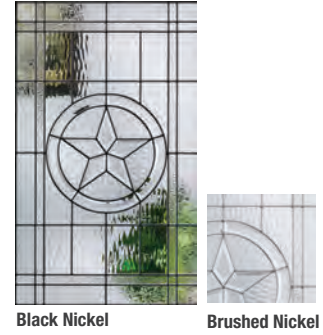

Black Nickel
Brushed Nickel
Texas Star
Glass Privacy Rating: 5

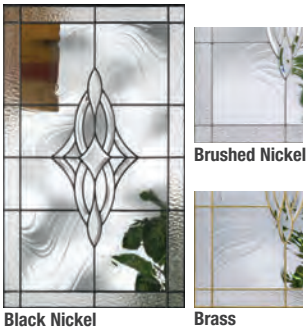

Black Nickel
Brass
Wellesley
Glass Privacy Rating: 6



Wrought Iron
Riserva
Glass Privacy Rating: 10

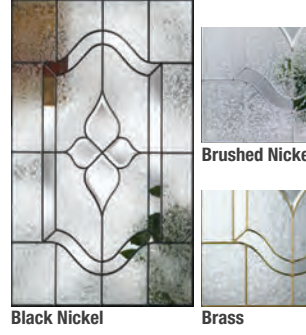

Black Nickel
Brass
Concorde
Glass Privacy Rating: 8



Black Nickel
Brushed Nickel
Kensington
Glass Privacy Rating: 8



Black Nickel
Brass***
Pembridge
Glass Privacy Rating: 7



Black Nickel
Axis
Glass Privacy Rating: 7



Frosted Images
Glass Privacy Rating: 8

Also Available:
Internal Blinds
Screen Vented

Glass Privacy Rating Scale



Clear

Opaque

Privacy & Textured Glass



Reeded (XK)
Glass Privacy Rating: **7**

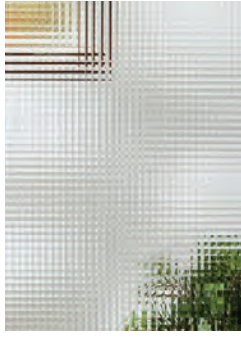

Geometric (XG)
Glass Privacy Rating: **7**



Satin Etch (XE)
Glass Privacy Rating: **10**



Chord (XC)
Glass Privacy Rating: **10**



Chinchilla (XJ)
Glass Privacy Rating: **10**



Rainglass (XR)
Glass Privacy Rating: **8**



Granite (XN)
Glass Privacy Rating: **10**

Glass Privacy Rating Scale

1 2 3 4 5 6 7 8 9 10

Clear

Opaque

Also Available:

Divided Lites
Clear Glass



Note: See page 299 for important product details that may help with your purchase decision.

Bottom: Profiles, Salinas Glass, Door – 968HD, Sidelites – 971SLHD

Blackstone®



310

2'6" x 6'8" Δ (7'0")
2'8" x 6'8" Δ (7'0")
2'10" x 6'8" Δ (7'0")
3'0" x 6'8" Δ (7'0")
3'6" x 6'8" (7'0")



310SL

10" x 6'8"
12" x 6'8" (7'0")
14" x 6'8" (7'0")

Crystalline™



916

2'8" x 6'8" (7'0")
2'10" x 6'8" Δ (7'0")
3'0" x 6'8" Δ (7'0")
3'6" x 6'8" (7'0")



916SL

10" x 6'8"
12" x 6'8" (7'0")
14" x 6'8" (7'0")

Sedona



139

2'6" x 6'8" Δ (7'0")
2'8" x 6'8" Δ (7'0")
2'10" x 6'8" Δ (7'0")
3'0" x 6'8" Δ (7'0")
3'6" x 6'8" (7'0")



139SL

10" x 6'8"
12" x 6'8" (7'0")
14" x 6'8" (7'0")

Salinas®



369

2'6" x 6'8" Δ (7'0")
2'8" x 6'8" Δ (7'0")
2'10" x 6'8" Δ (7'0")
3'0" x 6'8" Δ (7'0")
3'6" x 6'8" (7'0")



369SL

10" x 6'8"
12" x 6'8" (7'0")
14" x 6'8" (7'0")

Maple Park®



1006

2'8" x 6'8" (7'0")
2'10" x 6'8" Δ (7'0")
3'0" x 6'8" Δ (7'0")
3'6" x 6'8" (7'0")



1006SL

10" x 6'8"
12" x 6'8" (7'0")
14" x 6'8" (7'0")

Avonlea®



1027

2'8" x 6'8" (7'0")
2'10" x 6'8" Δ (7'0")
3'0" x 6'8" Δ (7'0")
3'6" x 6'8" (7'0")



1027SL

10" x 6'8"
12" x 6'8" (7'0")
14" x 6'8" (7'0")

Saratoga™



610

2'6" x 6'8" Δ (7'0")
2'8" x 6'8" Δ (7'0")
2'10" x 6'8" Δ (7'0")
3'0" x 6'8" Δ (7'0")
3'6" x 6'8" (7'0")



610SL

10" x 6'8"
12" x 6'8" (7'0")
14" x 6'8" (7'0")

Texas Star



1029

2'8" x 6'8" (7'0")
2'10" x 6'8" Δ (7'0")
3'0" x 6'8" Δ (7'0")
3'6" x 6'8" (7'0")



1029SL

10" x 6'8"
12" x 6'8" (7'0")
14" x 6'8" (7'0")

Wellesley™



620

2'6" x 6'8" Δ (7'0")
2'8" x 6'8" Δ (7'0")
2'10" x 6'8" Δ (7'0")
3'0" x 6'8" Δ (7'0")
3'6" x 6'8" (7'0")



620SL

10" x 6'8"
12" x 6'8" (7'0")
14" x 6'8" (7'0")

Key

- ◆ Black Nickel Caming (1D)
- Brushed Nickel Caming (1C)
- ◆ Brass Caming (1A)
- ✕ Wrought Iron (1W)
- NEW Scrolled & Flat Advanta Lite Frame
- WBDR / HVHZ Options
- Δ 6'6" Height Available

Riserva ✕



571
 2'6" x 6'8" Δ (7'0")
 2'8" x 6'8" Δ (7'0")
 2'10" x 6'8" Δ (7'0")
 3'0" x 6'8" Δ (7'0")
 3'6" x 6'8" (7'0")



TS572SL
 10" x 6'8"
 12" x 6'8" (7'0")
 14" x 6'8" (7'0")

Concorde ◆ ◆ ◆ ◆



1028
 2'6" x 6'8" Δ (7'0")
 2'8" x 6'8" Δ (7'0")
 2'10" x 6'8" Δ (7'0")
 3'0" x 6'8" Δ (7'0")
 3'6" x 6'8" (7'0")



416SL
 10" x 6'8"
 12" x 6'8" (7'0")
 14" x 6'8" (7'0")

Kensington ◆ ◆ ◆ ◆



626
 2'8" x 6'8" (7'0")
 2'10" x 6'8" Δ (7'0")
 3'0" x 6'8" Δ (7'0")
 3'6" x 6'8" (7'0")



626SL
 10" x 6'8"
 12" x 6'8" (7'0")
 14" x 6'8" (7'0")

Pembridge ◆ ◆ ◆ ◆



6500HD
 2'8" x 6'8" Δ (7'0")
 2'10" x 6'8" Δ (7'0")
 3'0" x 6'8" Δ (7'0")
 3'6" x 6'8" (7'0")



6500SL
 10" x 6'8"
 12" x 6'8" (7'0")
 14" x 6'8" (7'0")

Axis ◆



1651HD
 2'4" x 6'8" Δ
 2'6" x 6'8" Δ (7'0")
 2'8" x 6'8" Δ (7'0")
 2'10" x 6'8" Δ (7'0")
 3'0" x 6'8" Δ (7'0")
 3'6" x 6'8" (7'0")



1651SL
 10" x 6'8"
 12" x 6'8" (7'0")
 14" x 6'8" (7'0")

Frosted Images



138SL
 10" x 6'8"
 12" x 6'8" (7'0")
 14" x 6'8" (7'0")

Privacy & Textured Glass with Divided Lites



128
 2'8" x 6'8" Δ (7'0")
 2'10" x 6'8" Δ (7'0")
 3'0" x 6'8" Δ (7'0")
 3'6" x 6'8" (7'0")



108
 2'8" x 6'8" Δ (7'0")
 2'10" x 6'8" Δ (7'0")
 3'0" x 6'8" Δ (7'0")
 3'6" x 6'8" (7'0")



6184_SL*
 10" x 6'8"
 12" x 6'8" (7'0")
 14" x 6'8" (7'0")



6185_SL*
 10" x 6'8"
 12" x 6'8" (7'0")
 14" x 6'8" (7'0")



6186_SL*
 10" x 6'8"
 12" x 6'8" (7'0")
 14" x 6'8" (7'0")



632_SL
 10" x 6'8"
 12" x 6'8" (7'0")
 14" x 6'8" (7'0")

Privacy & Textured Glass



118
 2'8" x 6'8" Δ (7'0")
 2'10" x 6'8" Δ (7'0")
 3'0" x 6'8" Δ (7'0")
 3'6" x 6'8" (7'0")



100_SL
 10" x 6'8"
 12" x 6'8" (7'0")
 14" x 6'8" (7'0")

Privacy & Textured Glass Options

Add the code to the blank in the style number for the desired door and glass combination. For details on glass options, see page 232.

XK = Reeded

XG = Geometric

XE = Satin Etch

XC = Chord

XJ = Chinchilla

XR = Rainglass

XN = Granite

*Not available with Reeded (XK) or Geometric (XG) glass.

**Not recommended for use behind storm doors or to be painted dark colors, if exposed to direct sunlight.

Note: See page 299 for important product details that may help with your purchase decision.

Internal Blinds



130
 * 2 6
 2'4" x 6'8" Δ (7'0")
 2'6" x 6'8" Δ (7'0")
 2'8" x 6'8" Δ (7'0")
 2'10" x 6'8" Δ (7'0")
 3'0" x 6'8" Δ (7'0")
 3'6" x 6'8" (7'0")



130SL
 * 2 6
 10" x 6'8"
 12" x 6'8" (7'0")
 14" x 6'8" (7'0")

Clear Glass with Divided Lites



1201
 * 2 6
 2'6" x 6'8" Δ (7'0")
 2'8" x 6'8" Δ (7'0")
 2'10" x 6'8" Δ (7'0")
 3'0" x 6'8" Δ (7'0")
 3'6" x 6'8" (7'0")



1202
 * 2 6
 2'6" x 6'8" Δ (7'0")
 2'8" x 6'8" Δ (7'0")
 2'10" x 6'8" Δ (7'0")
 3'0" x 6'8" Δ (7'0")
 3'6" x 6'8" (7'0")



1203
 * 2 6
 2'6" x 6'8" Δ (7'0")
 2'8" x 6'8" Δ (7'0")
 2'10" x 6'8" Δ (7'0")
 3'0" x 6'8" Δ (7'0")
 3'6" x 6'8" (7'0")



128
 * 2 6
 2'6" x 6'8" Δ (7'0")
 2'8" x 6'8" (7'0")
 2'10" x 6'8" Δ (7'0")
 3'0" x 6'8" Δ (7'0")
 3'6" x 6'8" (7'0")



1200
 * 2 6
 2'6" x 6'8" Δ (7'0")
 2'8" x 6'8" Δ (7'0")
 2'10" x 6'8" Δ (7'0")
 3'0" x 6'8" Δ (7'0")
 3'6" x 6'8" (7'0")



108
 * 2 6
 2'6" x 6'8" Δ (7'0")
 2'8" x 6'8" (7'0")
 2'10" x 6'8" Δ (7'0")
 3'0" x 6'8" Δ (7'0")
 3'6" x 6'8" (7'0")



1201SL
 * 2 6
 10" x 6'8"
 12" x 6'8" (7'0")
 14" x 6'8" (7'0")



1202SL
 * 2 6
 10" x 6'8"
 12" x 6'8" (7'0")
 14" x 6'8" (7'0")



1200SL
 * 2 6
 10" x 6'8"
 12" x 6'8" (7'0")
 14" x 6'8" (7'0")



632SL
 * 2 6
 10" x 6'8"
 12" x 6'8" (7'0")
 14" x 6'8" (7'0")



6184SL
 * 2 6
 10" x 6'8"
 12" x 6'8" (7'0")
 14" x 6'8" (7'0")



6185SL
 * 2 6
 10" x 6'8"
 12" x 6'8" (7'0")
 14" x 6'8" (7'0")



6186SL
 * 2 6
 10" x 6'8"
 12" x 6'8" (7'0")
 14" x 6'8" (7'0")

Clear Glass



198
 * 2 6
 2'6" x 6'8" Δ (7'0")
 2'8" x 6'8" Δ (7'0")
 2'10" x 6'8" Δ (7'0")
 3'0" x 6'8" Δ (7'0")
 3'6" x 6'8" (7'0")



198SL
 * 2 6
 10" x 6'8"
 12" x 6'8" (7'0")
 14" x 6'8" (7'0")



118
 * 2 6
 2'0" x 6'8" ▽
 2'4" x 6'8" Δ
 2'6" x 6'8" Δ (7'0")
 2'8" x 6'8" (7'0")
 2'10" x 6'8" Δ (7'0")
 3'0" x 6'8" Δ (7'0")
 3'6" x 6'8" (7'0")



100SL
 * 2 6
 10" x 6'8"
 12" x 6'8" (7'0")
 14" x 6'8" (7'0")

Key

- Low-E Glass (LE)
- Turtle Glass
- Black Nickel Caming (1D)
- Brushed Nickel Caming (1C)
- Brass Caming (1A)
- Wrought Iron (1W)
- Simulated Divided Lites (SDL)
- Flat or Contour, White Grilles Between Glass (GBGF / GBGC)
- Flat or Contour, Almond Grilles Between Glass (GBGF / GBGC)
- Flat or Contour, Bronze Grilles Between Glass (GBGF / GBGC)
- Flat or Contour, Black Grilles Between Glass (GBGF / GBGC)
- Fixed Grilles (FXG)
- NEW Scrolled & Flat Advanta Lite Frame
- NEW Scrolled Advanta Lite Frame
- WBDR / HVHZ Options
- 6'6" Height Available
- PVC Doorlite Frame**

Blackstone.



1037HD
 2'8" x 6'8"
 2'10" x 6'8"
 3'0" x 6'8"



1037SLHD
 12" x 6'8"
 14" x 6'8"

Crystalline™



1042HD
 2'8" x 6'8"
 2'10" x 6'8"
 3'0" x 6'8"



956SLHD
 12" x 6'8"
 14" x 6'8"

Sedona



965HD
 2'8" x 6'8"
 2'10" x 6'8"
 3'0" x 6'8"



965SLHD
 12" x 6'8"
 14" x 6'8"

Salinas.



968HD
 2'8" x 6'8"
 2'10" x 6'8"
 3'0" x 6'8"



971SLHD
 12" x 6'8"
 14" x 6'8"

Maple Park.



1009HD
 2'8" x 6'8"
 2'10" x 6'8"
 3'0" x 6'8"



1009SLHD
 12" x 6'8"
 14" x 6'8"

Avonlea.



1038HD
 2'8" x 6'8"
 2'10" x 6'8"
 3'0" x 6'8"



1038SLHD
 12" x 6'8"
 14" x 6'8"

Saratoga™



1039HD
 2'8" x 6'8"
 2'10" x 6'8"
 3'0" x 6'8"



1039SLHD
 12" x 6'8"
 14" x 6'8"

Texas Star



1040HD
 2'8" x 6'8"
 2'10" x 6'8"
 3'0" x 6'8"



1040SLHD
 12" x 6'8"
 14" x 6'8"

Wellesley™



1041HD
 2'8" x 6'8"
 2'10" x 6'8"
 3'0" x 6'8"



1041SLHD
 12" x 6'8"
 14" x 6'8"

Riserva.



544HD
 2'8" x 6'8"
 2'10" x 6'8"
 3'0" x 6'8"



546SLHD
 12" x 6'8"
 14" x 6'8"

Concorde™



967HD
 2'8" x 6'8"
 2'10" x 6'8"
 3'0" x 6'8"



967SLHD
 12" x 6'8"
 14" x 6'8"

Kensington™



03142HD
 2'8" x 6'8"
 2'10" x 6'8"
 3'0" x 6'8"



966SLHD
 12" x 6'8"
 14" x 6'8"

Privacy & Textured Glass Options

Add the code to the blank in the style number for the desired door and glass combination. For details on glass options, see page 232.

XK = Reeded

XG = Geometric

XE = Satin Etch

XC = Chord

XJ = Chinchilla

XR = Rainglass

XN = Granite

Pembridge™



6582HD
 2'8" x 6'8"
 2'10" x 6'8"
 3'0" x 6'8"

6580SLHD
 12" x 6'8"
 14" x 6'8"

Axis



1644HD
 2'8" x 6'8"
 2'10" x 6'8"
 3'0" x 6'8"

1644SLHD
 12" x 6'8"
 14" x 6'8"

Privacy & Textured Glass



961HD
 2'8" x 6'8"
 2'10" x 6'8"
 3'0" x 6'8"

959HD
 2'8" x 6'8"
 2'10" x 6'8"
 3'0" x 6'8"

6720HD_SL
 12" x 6'8"
 14" x 6'8"

959HD_SL
 12" x 6'8"
 14" x 6'8"

Internal Blinds



5425
 2'8" x 6'8"
 2'10" x 6'8"
 3'0" x 6'8"

5425SL
 12" x 6'8"
 14" x 6'8"

Clear Glass with Divided Lites



2109HD
 2'8" x 6'8"
 2'10" x 6'8"
 3'0" x 6'8"

2110HD
 2'8" x 6'8"
 2'10" x 6'8"
 3'0" x 6'8"

2111HD
 2'8" x 6'8"
 2'10" x 6'8"
 3'0" x 6'8"

961HD
 2'8" x 6'8"
 2'10" x 6'8"
 3'0" x 6'8"

1089SLHD
 12" x 6'8"
 14" x 6'8"

4572SLHD
 12" x 6'8"
 14" x 6'8"

Clear Glass



6720SLHD
 12" x 6'8"
 14" x 6'8"

1403HD
 2'8" x 6'8"
 2'10" x 6'8"
 3'0" x 6'8"

1400SLHD
 12" x 6'8"
 14" x 6'8"

959HD
 2'8" x 6'8"
 2'10" x 6'8"
 3'0" x 6'8"

959SLHD
 12" x 6'8"
 14" x 6'8"

Key

- Low-E Glass (LE)
- Black Nickel Caming (1D)
- Brushed Nickel Caming (1C)
- Brass Caming (1A)
- Wrought Iron (1W)
- Simulated Divided Lites (SDL)
- Flat or Contour, White Grilles Between Glass (GBGF / GBGC)
- Flat or Contour, Bronze Grilles Between Glass (GBGF / GBGC)
- Flat or Contour, Almond Grilles Between Glass (GBGF / GBGC)
- Flat or Contour, Black Grilles Between Glass (GBGF / GBGC)
- WBDR / HVHZ Options

Oval Lites

Blackstone. ◆ ◆



1025HD
2'8" x 6'8"
2'10" x 6'8"
3'0" x 6'8"

Avonlea. ◆



1047HD
2'8" x 6'8"
2'10" x 6'8"
3'0" x 6'8"

Wellesley™ ◆ ◆ ◆



1022HD
2'8" x 6'8"
2'10" x 6'8"
3'0" x 6'8"

Concorde™ ◆ ◆ ◆



1024HD
2'8" x 6'8"
2'10" x 6'8"
3'0" x 6'8"

Kensington™ ◆ ◆



630HD
2'8" x 6'8"
2'10" x 6'8"
3'0" x 6'8"

Pembridge™ ◆ ◆ ◆



6578HD
2'8" x 6'8"
2'10" x 6'8"
3'0" x 6'8"

Frosted Images. ◆



1021HD
2'8" x 6'8"
2'10" x 6'8"
3'0" x 6'8"

Clear Glass ◆



1020HD
◆
2'8" x 6'8"
2'10" x 6'8"
3'0" x 6'8"

1/2 Lites

Blackstone. ◆ ◆



309HD
6
2'6" x 6'8"
2'8" x 6'8" (7'0")
2'10" x 6'8" (7'0")
3'0" x 6'8" (7'0")



1001HD
6
2'8" x 6'8"
2'10" x 6'8"
3'0" x 6'8"



1117HD
6
2'8" x 6'8"
2'10" x 6'8"
3'0" x 6'8"



311SLHD
6
12" x 6'8" (7'0")
14" x 6'8" (7'0")

Crystalline. ◆ ◆



926HD
6
2'8" x 6'8" (7'0")
2'10" x 6'8" (7'0")
3'0" x 6'8" (7'0")



991HD
6
2'8" x 6'8"
2'10" x 6'8"
3'0" x 6'8"



1119HD
6
2'8" x 6'8"
2'10" x 6'8"
3'0" x 6'8"



930SLHD
6
12" x 6'8" (7'0")
14" x 6'8" (7'0")

Sedona ◆ ◆



211HD 2'6" x 6'8" 2'8" x 6'8" (7'0") 2'10" x 6'8" (7'0") 3'0" x 6'8" (7'0")	996HD 2'8" x 6'8" 2'10" x 6'8" 3'0" x 6'8"	1114HD 2'8" x 6'8" 2'10" x 6'8" 3'0" x 6'8"	294SLHD 12" x 6'8" (7'0") 14" x 6'8" (7'0")
--	--	---	--

Salinas X



374HD 6 2'6" x 6'8" 2'8" x 6'8" (7'0") 2'10" x 6'8" (7'0") 3'0" x 6'8" (7'0")	1002HD 6 2'8" x 6'8" 2'10" x 6'8" 3'0" x 6'8"	1115HD 6 2'8" x 6'8" 2'10" x 6'8" 3'0" x 6'8"	371SLHD 6 12" x 6'8" (7'0") 14" x 6'8" (7'0")
---	--	--	---

Maple Park ◆ ◆



1007HD 6 2'8" x 6'8" (7'0") 2'10" x 6'8" (7'0") 3'0" x 6'8" (7'0")	1011HD 6 2'8" x 6'8" 2'10" x 6'8" 3'0" x 6'8"	1116HD 6 2'8" x 6'8" 2'10" x 6'8" 3'0" x 6'8"	1007SLHD 6 12" x 6'8" (7'0") 14" x 6'8" (7'0")
---	--	--	--

Avonlea ◆



1031HD 6 2'8" x 6'8" (7'0") 2'10" x 6'8" (7'0") 3'0" x 6'8" (7'0")	1034HD 6 2'8" x 6'8" 2'10" x 6'8" 3'0" x 6'8"	1107HD 6 2'8" x 6'8" 2'10" x 6'8" 3'0" x 6'8"	1031SLHD 6 12" x 6'8" (7'0") 14" x 6'8" (7'0")
---	--	--	--

Saratoga ◆ ◆



613HD 6 2'6" x 6'8" 2'8" x 6'8" (7'0") 2'10" x 6'8" (7'0") 3'0" x 6'8" (7'0")	988HD 6 2'8" x 6'8" 2'10" x 6'8" 3'0" x 6'8"	1112HD 6 2'8" x 6'8" 2'10" x 6'8" 3'0" x 6'8"	615SLHD 6 12" x 6'8" (7'0") 14" x 6'8" (7'0")
---	---	--	---

Texas Star ◆ ◆







1032HD 6 2'8" x 6'8" (7'0") 2'10" x 6'8" (7'0") 3'0" x 6'8" (7'0")	1035HD 6 2'8" x 6'8" 2'10" x 6'8" 3'0" x 6'8"	1111HD 6 2'8" x 6'8" 2'10" x 6'8" 3'0" x 6'8"
---	--	--





Key

- ◆ Low-E Glass (LE)
- ◆ Black Nickel Caming (1D)
- ◆ Brashed Nickel Caming (1C)
- ◆ Brashed Nickel Caming (1A)
- X Wrought Iron (1W)
- 6 WBDR / HVHZ Options



Wellesley™ ◆ ◆ ◆ ◆

			
623HD 6 2'6" x 6'8" 2'8" x 6'8" (7'0") 2'10" x 6'8" (7'0") 3'0" x 6'8" (7'0")	989HD 6 2'8" x 6'8" 2'10" x 6'8" 3'0" x 6'8"	1120HD 6 2'8" x 6'8" 2'10" x 6'8" 3'0" x 6'8"	625SLHD 6 12" x 6'8" (7'0") 14" x 6'8" (7'0")





Riserva® X

			
582HD 6 12" x 6'8" 2'8" x 6'8" (7'0") 2'10" x 6'8" (7'0") 3'0" x 6'8" (7'0")	576HD 6 2'8" x 6'8" 2'10" x 6'8" 3'0" x 6'8"	578HD 6 2'8" x 6'8" 2'10" x 6'8" 3'0" x 6'8"	584SLHD 6 12" x 6'8" (7'0") 14" x 6'8" (7'0")

Concorde™ ◆ ◆ ◆ ◆

			
426HD 6 2'6" x 6'8" 2'8" x 6'8" (7'0") 2'10" x 6'8" (7'0") 3'0" x 6'8" (7'0")	999HD 6 2'8" x 6'8" 2'10" x 6'8" 3'0" x 6'8"	1118HD 6 2'8" x 6'8" 2'10" x 6'8" 3'0" x 6'8"	430SLHD 6 12" x 6'8" (7'0") 14" x 6'8" (7'0")

Kensington™ ◆ ◆ ◆ ◆

			
627HD 6 2'8" x 6'8" (7'0") 2'10" x 6'8" (7'0") 3'0" x 6'8" (7'0")	631HD 6 2'8" x 6'8" 2'10" x 6'8" 3'0" x 6'8"	1113HD 6 2'8" x 6'8" 2'10" x 6'8" 3'0" x 6'8"	628SLHD 6 12" x 6'8" (7'0") 14" x 6'8" (7'0")

Pembridge™ ◆ ◆ ◆ ◆

			
6560HD 6 2'6" x 6'8" 2'8" x 6'8" (7'0") 2'10" x 6'8" (7'0") 3'0" x 6'8" (7'0")	6565HD 6 2'8" x 6'8" 2'10" x 6'8" 3'0" x 6'8"	6568HD 6 2'8" x 6'8" 2'10" x 6'8" 3'0" x 6'8"	6565SLHD 6 12" x 6'8" (7'0") 14" x 6'8" (7'0")

Axis® ◆

			
1660HD 6 2'6" x 6'8" 2'8" x 6'8" (7'0") 2'10" x 6'8" (7'0") 3'0" x 6'8" (7'0")	1657HD 6 2'8" x 6'8" 2'10" x 6'8" 3'0" x 6'8"	1659HD 6 2'8" x 6'8" 2'10" x 6'8" 3'0" x 6'8"	1657SLHD 6 12" x 6'8" (7'0") 14" x 6'8" (7'0")

Privacy & Textured Glass Options

Add the code to the blank in the style number for the desired door and glass combination. For details on glass options, see page 232.

XK = Reeded
XG = Geometric

XE = Satin Etch
XC = Chord



XJ = Chinchilla
XR = Rainglass

XN = Granite

*Features a gliding operation and sash locking system.

Note: See page 299 for important product details that may help with your purchase decision.

Frosted Images.

			
206EHD 6 2'8" x 6'8" (7'0") 2'10" x 6'8" (7'0") 3'0" x 6'8" (7'0")	985HD 6 2'8" x 6'8" 2'10" x 6'8" 3'0" x 6'8"	1110HD 6 2'8" x 6'8" 2'10" x 6'8" 3'0" x 6'8"	289ESLHD 6 12" x 6'8" (7'0") 14" x 6'8" (7'0")

Privacy & Textured Glass with Divided Lites

		
262HD __ 2'8" x 6'8" (7'0") 2'10" x 6'8" (7'0") 3'0" x 6'8" (7'0")	982HD __ 2'8" x 6'8" 2'10" x 6'8" 3'0" x 6'8"	1123HD __ 2'8" x 6'8" 2'10" x 6'8" 3'0" x 6'8"







Privacy & Textured Glass

					
263SLHD __ 12" x 6'8" (7'0") 14" x 6'8" (7'0")	206HD __ 6 2'8" x 6'8" (7'0") 2'10" x 6'8" (7'0") 3'0" x 6'8" (7'0")	980HD __ 6 2'8" x 6'8" 2'10" x 6'8" 3'0" x 6'8"	1101 __HD 6 2'8" x 6'8" 2'10" x 6'8" 3'0" x 6'8"	104 __ 6 E 2'8" x 6'8" (7'0") 2'10" x 6'8" (7'0") 3'0" x 6'8" (7'0")	210SLHD __ 6 12" x 6'8" (7'0") 14" x 6'8" (7'0")







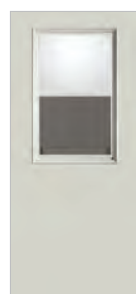

Internal Blinds

132HD 6 2'6" x 6'8" 2'8" x 6'8" (7'0") 2'10" x 6'8" (7'0") 3'0" x 6'8" (7'0")

Screen Vented Lites*

							
984HD 6 2'8" x 6'8" 2'10" x 6'8" 3'0" x 6'8"	1121HD 6 2'8" x 6'8" 2'10" x 6'8" 3'0" x 6'8"	131 6 E 2'6" x 6'8" (7'0") 2'8" x 6'8" (7'0") 2'10" x 6'8" (7'0") 3'0" x 6'8" (7'0")	132SLHD 6 12" x 6'8" (7'0") 14" x 6'8" (7'0")	243HD 2'8" x 6'8" (7'0") 2'10" x 6'8" (7'0") 3'0" x 6'8" (7'0")	1004HD 2'8" x 6'8" 2'10" x 6'8" 3'0" x 6'8"	1102HD 2'8" x 6'8" 2'10" x 6'8" 3'0" x 6'8"	137 E 2'8" x 6'8" (7'0") 2'10" x 6'8" (7'0") 3'0" x 6'8" (7'0")

Key

-  Low-E Glass (LE)
-  Black Nickel Caming (1D)
-  Brushed Nickel Caming (1C)
-  Brass Caming (1A)
-  Wrought Iron (1W)
-  Simulated Divided Lites (SDL)
-  WBDR / HVHZ Options
-  Elevated 10" Bottom Rail Options

Clear Glass with Divided Lites



262HD
 * * * * * 6
 2'6" x 6'8"
 2'8" x 6'8" (7'0")
 2'10" x 6'8" (7'0")
 3'0" x 6'8" (7'0")



982HD
 * * * * * 6
 2'8" x 6'8"
 2'10" x 6'8"
 3'0" x 6'8"



1123HD
 * * * * * 6
 2'8" x 6'8"
 2'10" x 6'8"
 3'0" x 6'8"

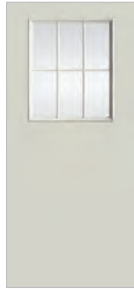

115HD
 * * * * * E
 2'6" x 6'8" (7'0")
 2'8" x 6'8" (7'0")
 2'10" x 6'8" (7'0")
 3'0" x 6'8" (7'0")



263SLHD
 * * * * * 6
 12" x 6'8" (7'0")
 14" x 6'8" (7'0")



1408HD
 * * * * *
 2'6" x 6'8"
 2'8" x 6'8" (7'0")
 2'10" x 6'8" (7'0")
 3'0" x 6'8" (7'0")



1405HD
 * * * * *
 2'8" x 6'8"
 2'10" x 6'8"
 3'0" x 6'8"



1406HD
 * * * * *
 2'8" x 6'8"
 2'10" x 6'8"
 3'0" x 6'8"

Clear Glass



1405SLHD
 * * * * *



206HD
 * * *
 2'6" x 6'8"
 2'8" x 6'8" (7'0")
 2'10" x 6'8" (7'0")
 3'0" x 6'8" (7'0")



980HD
 * * *
 2'8" x 6'8"
 2'10" x 6'8"
 3'0" x 6'8"



1101HD
 * * *
 2'8" x 6'8"
 2'10" x 6'8"
 3'0" x 6'8"

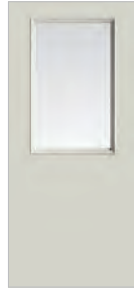

104
 * * * * * E
 2'6" x 6'8" (7'0")
 2'8" x 6'8" (7'0")
 2'10" x 6'8" (7'0")
 3'0" x 6'8" (7'0")

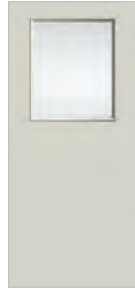

105
 * * * * * E
 2'6" x 6'8" (7'0")
 2'8" x 6'8" (7'0")
 2'10" x 6'8" (7'0")
 3'0" x 6'8" (7'0")



210SLHD
 * * *
 12" x 6'8" (7'0")
 14" x 6'8" (7'0")



Note: See page 299 for important product details that may help with your purchase decision.

Bottom: Profiles, Frosted Images Glass, Door – 206EHD, Sidelite – 289ESLHD

Blackstone®



311HD
2'6" x 6'8" (7'0")
2'8" x 6'8" (7'0")
2'10" x 6'8" (7'0")
3'0" x 6'8" (7'0")

Crystalline™



930HD
2'6" x 6'8" (7'0")
2'8" x 6'8" (7'0")
2'10" x 6'8" (7'0")
3'0" x 6'8" (7'0")

Sedona



294HD
2'6" x 6'8" (7'0")
2'8" x 6'8" (7'0")
2'10" x 6'8" (7'0")
3'0" x 6'8" (7'0")

Salinas®



371HD
2'6" x 6'8" (7'0")
2'8" x 6'8" (7'0")
2'10" x 6'8" (7'0")
3'0" x 6'8" (7'0")

Maple Park®



1008HD
2'6" x 6'8" (7'0")
2'8" x 6'8" (7'0")
2'10" x 6'8" (7'0")
3'0" x 6'8" (7'0")

Avonlea®



1044HD
2'6" x 6'8" (7'0")
2'8" x 6'8" (7'0")
2'10" x 6'8" (7'0")
3'0" x 6'8" (7'0")

Saratoga™



615HD
2'6" x 6'8" (7'0")
2'8" x 6'8" (7'0")
2'10" x 6'8" (7'0")
3'0" x 6'8" (7'0")

Wellesley™



625HD
2'6" x 6'8" (7'0")
2'8" x 6'8" (7'0")
2'10" x 6'8" (7'0")
3'0" x 6'8" (7'0")

Riserva®



588HD
2'6" x 6'8" (7'0")
2'8" x 6'8" (7'0")
2'10" x 6'8" (7'0")
3'0" x 6'8" (7'0")

Concorde™



430HD
2'6" x 6'8" (7'0")
2'8" x 6'8" (7'0")
2'10" x 6'8" (7'0")
3'0" x 6'8" (7'0")

Kensington™



628HD
2'6" x 6'8" (7'0")
2'8" x 6'8" (7'0")
2'10" x 6'8" (7'0")
3'0" x 6'8" (7'0")

Pembridge™



6572HD
2'6" x 6'8"
2'8" x 6'8" (7'0")
2'10" x 6'8" (7'0")
3'0" x 6'8" (7'0")

Axis®



1662HD
2'6" x 6'8" (7'0")
2'8" x 6'8" (7'0")
2'10" x 6'8" (7'0")
3'0" x 6'8" (7'0")

Frosted Images®



289EHD
2'6" x 6'8" (7'0")
2'8" x 6'8" (7'0")
2'10" x 6'8" (7'0")
3'0" x 6'8" (7'0")

Key

- Low-E Glass (LE)
- Black Nickel Caming (1D)
- Brushed Nickel Caming (1C)
- Brass Caming (1A)
- Wrought Iron (1W)
- Simulated Divided Lites (SDL)
- Flat or Contour, White Grilles Between Glass (GBGF / GBGC)
- Flat or Contour, Bronze Grilles Between Glass (GBGF / GBGC)
- Flat or Contour, Almond Grilles Between Glass (GBGF / GBGC)
- Flat or Contour, Black Grilles Between Glass (GBGF / GBGC)
- Fixed Grilles (FXG)
- WBDR / HVHZ Options
- Elevated 10" Bottom Rail Options

Privacy & Textured Glass



263HD
 ■
 2'6" x 6'8" (7'0")
 2'8" x 6'8" (7'0")
 2'10" x 6'8" (7'0")
 3'0" x 6'8" (7'0")



289HD
 ■
 2'8" x 6'8" (7'0")
 2'10" x 6'8" (7'0")
 3'0" x 6'8" (7'0")

Clear Glass with Divided Lites



263HD
 ■ ◆ ◆ ◆ ◆ ◆
 2'6" x 6'8" (7'0")
 2'8" x 6'8" (7'0")
 2'10" x 6'8" (7'0")
 3'0" x 6'8" (7'0")



1411HD
 ■ ◆ ◆ ◆ ◆ ◆
 2'6" x 6'8" (7'0")
 2'8" x 6'8" (7'0")
 2'10" x 6'8" (7'0")
 3'0" x 6'8" (7'0")

Clear Glass



289HD
 ■
 2'6" x 6'8" (7'0")
 2'8" x 6'8" (7'0")
 2'10" x 6'8" (7'0")
 3'0" x 6'8" (7'0")

Craftsman Lites

Sedona



604HD
 ■ ◆ ◆
 2'8" x 6'8"
 2'10" x 6'8"
 3'0" x 6'8"

Maple Park.



609HD
 ■ ◆ ◆
 2'8" x 6'8"
 2'10" x 6'8"
 3'0" x 6'8"

Saratoga™



602HD
 ■ ◆ ◆
 2'8" x 6'8"
 2'10" x 6'8"
 3'0" x 6'8"

Riserva.



508HD
 ■ ◆ ◆
 2'8" x 6'8"
 2'10" x 6'8"
 3'0" x 6'8"

Pembridge™



6520HD
 ■ ◆ ◆ ◆ ◆
 2'8" x 6'8"
 2'10" x 6'8"
 3'0" x 6'8"

Axis.



1650HD
 ■ ◆ ◆ ◆ ◆ ◆
 2'8" x 6'8"
 2'10" x 6'8"
 3'0" x 6'8"

Privacy & Textured Glass with Divided Lites



605HD*
 ■ ◆ ◆ ◆ ◆ ◆
 2'8" x 6'8"
 2'10" x 6'8"
 3'0" x 6'8"



606HD*
 ■ ◆ ◆ ◆ ◆ ◆
 2'8" x 6'8"
 2'10" x 6'8"
 3'0" x 6'8"



607HD*
 ■ ◆ ◆ ◆ ◆ ◆
 2'8" x 6'8"
 2'10" x 6'8"
 3'0" x 6'8"



608HD*
 ■ ◆ ◆ ◆ ◆ ◆
 2'8" x 6'8"
 2'10" x 6'8"
 3'0" x 6'8"

Privacy & Textured Glass



601_HD*
 ■ ◆ ◆ ◆ ◆ ◆
 2'8" x 6'8"
 2'10" x 6'8"
 3'0" x 6'8"

Privacy & Textured Glass Options

Add the code to the blank in the style number for the desired door and glass combination. For details on glass options, see page 232.

XK = Reeded

XG = Geometric

XE = Satin Etch

XC = Chord

XJ = Chinchilla

XR = Rainglass

XN = Granite

*Not available with Reeded (XK) or Geometric (XG) glass.

Note: See page 299 for important product details that may help with your purchase decision.

Clear Glass with Divided Lites



- 605HD**
◆ ◆ ◆
 2'8" x 6'8"
 2'10" x 6'8"
 3'0" x 6'8"
- 606HD**
◆ ◆ ◆
 2'8" x 6'8"
 2'10" x 6'8"
 3'0" x 6'8"
- 607HD**
◆ ◆ ◆
 2'8" x 6'8"
 2'10" x 6'8"
 3'0" x 6'8"
- 608HD**
◆ ◆ ◆
 2'8" x 6'8"
 2'10" x 6'8"
 3'0" x 6'8"

Clear Glass



- 601HD**
◆ ◆ ◆ ◆
 2'8" x 6'8"
 2'10" x 6'8"
 3'0" x 6'8"

Minimal Lites

Maple Park.



- 736HD**
◆ ◆ ◆ ◆
 2'8" x 6'8" (7'0")
 2'10" x 6'8" (7'0")
 3'0" x 6'8" (7'0")

Saratoga™



- 707HD**
◆ ◆ ◆
 2'8" x 6'8" (7'0")
 2'10" x 6'8" (7'0")
 3'0" x 6'8" (7'0")

Wellesley™



- 721HD**
◆ ◆ ◆ ◆
 2'8" x 6'8" (7'0")
 2'10" x 6'8" (7'0")
 3'0" x 6'8" (7'0")

Concorde™



- 735HD**
◆ ◆ ◆ ◆
 2'8" x 6'8" (7'0")
 2'10" x 6'8" (7'0")
 3'0" x 6'8" (7'0")

Pembridge™



- 745HD**
◆ ◆ ◆ ◆
 2'8" x 6'8" (7'0")
 2'10" x 6'8" (7'0")
 3'0" x 6'8" (7'0")

Clear Glass with Divided Lites



- 752HD**
◆ ◆ ◆ ◆
 2'8" x 6'8" (7'0")
 2'10" x 6'8" (7'0")
 3'0" x 6'8" (7'0")
- 704HD**
◆ ◆ ◆
 2'8" x 6'8" (7'0")
 2'10" x 6'8" (7'0")
 3'0" x 6'8" (7'0")

Clear Glass



- 708HD**
◆
 2'8" x 6'8" (7'0")
 2'10" x 6'8" (7'0")
 3'0" x 6'8" (7'0")

Crystalline™



- 1055HD**
◆
 2'8" x 6'8" (7'0")
 2'10" x 6'8" (7'0")
 3'0" x 6'8" (7'0")

Concorde™



- 454HD**
◆ ◆ ◆ ◆
 2'8" x 6'8" (7'0")
 2'10" x 6'8" (7'0")
 3'0" x 6'8" (7'0")

Key

- ◆ Low-E Glass (LE)
- ◆ Black Nickel Caming (1D)
- ◆ Brushed Nickel Caming (1C)
- ◆ Brass Caming (1A)
- ✗ Wrought Iron (1W)
- 🌀 WBDR / HVHZ Options
- 👁️ Simulated Divided Lites (SDL)
- ◆ Flat or Contour, White Grilles Between Glass (GBGF / GBGC)
- ◆ Flat or Contour, Almond Grilles Between Glass (GBGF / GBGC)
- ◆ Flat or Contour, Bronze Grilles Between Glass (GBGF / GBGC)
- ◆ Flat or Contour, Black Grilles Between Glass (GBGF / GBGC)
- ◆ Fixed Grilles (FXG)
- 👁️ NEW Scrolled & Flat Advanta Lite Frame
- 👁️ NEW Scrolled Advanta Lite Frame

Clear Glass with Divided Lites



255HD
 * ♦ ♦ ♦ ♦ ♦
 2'8" x 6'8" (7'0")
 2'10" x 6'8" (7'0")
 3'0" x 6'8" (7'0")

Clear Glass



256HD
 *
 2'8" x 6'8" (7'0")
 2'10" x 6'8" (7'0")
 3'0" x 6'8" (7'0")

Clear Glass with Divided Lites



236HD
 ♦
 2'8" x 6'8" (7'0")
 2'10" x 6'8" (7'0")
 3'0" x 6'8" (7'0")



237HD
 * ♦
 2'8" x 6'8" (7'0")
 2'10" x 6'8" (7'0")
 3'0" x 6'8" (7'0")
 (Scalloped Lite Frame)

Pembridge™
 ♦ ♦ ♦



6570HD
 2'8" x 6'8" (7'0")
 2'10" x 6'8" (7'0")
 3'0" x 6'8" (7'0")



6570SLHD
 12" x 6'8" (7'0")
 14" x 6'8" (7'0")

Axis™
 ♦



1643HD
 2'8" x 6'8" (7'0")
 2'10" x 6'8" (7'0")
 3'0" x 6'8" (7'0")



1643SLHD
 12" x 6'8" (7'0")
 14" x 6'8" (7'0")

Privacy & Textured Glass



296HD
 2'8" x 6'8" (7'0")
 2'10" x 6'8" (7'0")
 3'0" x 6'8" (7'0")



296SLHD
 12" x 6'8" (7'0")
 14" x 6'8" (7'0")

Clear Glass



296HD
 *
 2'8" x 6'8" (7'0")
 2'10" x 6'8" (7'0")
 3'0" x 6'8" (7'0")



296SLHD
 *
 12" x 6'8" (7'0")
 14" x 6'8" (7'0")

Solid Panels



969HD
 6
 2'8" x 6'8"
 2'10" x 6'8"
 3'0" x 6'8"



978HD
 6
 2'8" x 6'8"
 2'10" x 6'8"
 3'0" x 6'8"



1005HD
 6
 2'8" x 6'8"
 2'10" x 6'8"
 3'0" x 6'8"



205HD
 6
 2'8" x 6'8"
 2'10" x 6'8"
 3'0" x 6'8"



203HD
 6
 2'8" x 6'8"
 2'10" x 6'8"
 3'0" x 6'8"



210HD
 6
 2'6" x 6'8" (7'0")
 2'8" x 6'8" (7'0")
 2'10" x 6'8" (7'0")
 3'0" x 6'8" (7'0")



100
 6 E
 2'0" x 6'8"
 2'4" x 6'8" Δ
 2'6" x 6'8" Δ (7'0")
 2'8" x 6'8" Δ (7'0")
 2'10" x 6'8" Δ (7'0")
 3'0" x 6'8" Δ (7'0")
 3'6" x 6'8" (7'0")

Privacy & Textured Glass Options

Add the code to the blank in the style number for the desired door and glass combination. For details on glass options, see page 232.

XK = Reeded

XG = Geometric

XE = Satin Etch

XC = Chord

XJ = Chinchilla

XR = Rainglass

XN = Granite

*Not available with Reeded (XK) or Geometric (XG) glass.

Note: See page 299 for important product details that may help with your purchase decision.



Full Lites

Privacy & Textured

Glass with Divided Lites





TS128_
 2'8" x 6'8"
 2'10" x 6'8"
 3'0" x 6'8"





TS108_
 2'8" x 6'8"
 2'10" x 6'8"
 3'0" x 6'8"





6184_SL*
 10" x 6'8"
 12" x 6'8" (7'0")
 14" x 6'8" (7'0")





6185_SL*
 10" x 6'8"
 12" x 6'8" (7'0")
 14" x 6'8" (7'0")



6186_SL*
 10" x 6'8"
 12" x 6'8" (7'0")
 14" x 6'8" (7'0")





632_SL
 10" x 6'8"
 12" x 6'8" (7'0")
 14" x 6'8" (7'0")

Privacy & Textured Glass



TS118_
 2'8" x 6'8"
 2'10" x 6'8"
 3'0" x 6'8"

818_
 2'6" x 8'0"
 2'10" x 8'0"
 3'0" x 8'0"

Privacy & Textured Glass *Continue on next page.*

Key

-  Low-E Glass (LE)
-  Black Nickel Caming (1D)
-  Brushed Nickel Caming (1C)
-  Brass Caming (1A)
-  Simulated Divided Lites (SDL)
-  Flat or Contour, White Grilles Between Glass (GBGF / GBGC)
-  Flat or Contour, Almond Grilles Between Glass (GBGF / GBGC)
-  Flat or Contour, Bronze Grilles Between Glass (GBGF / GBGC)
-  Fixed Grilles (FXG)
-  NEW Scrolled & Flat Advanta Lite Frame
-  NEW Scrolled Advanta Lite Frame
-  WBDR / HVHZ Options
-  6'6" Height Available
-  Elevated 10" Bottom Rail Options

Privacy & Textured Glass



100_SL
 10" x 6'8"
 12" x 6'8" (7'0")
 14" x 6'8" (7'0")

818_SL
 12" x 8'0"
 14" x 8'0"

Internal Blinds



TS130
 2'4" x 6'8"
 2'6" x 6'8"
 2'8" x 6'8"
 2'10" x 6'8"
 3'0" x 6'8"

829
 2'6" x 8'0"
 2'8" x 8'0"
 2'10" x 8'0"
 3'0" x 8'0"



130SL
 10" x 6'8"
 12" x 6'8" (7'0")
 14" x 6'8" (7'0")

829SL
 12" x 8'0"
 14" x 8'0"

Clear Glass with Divided Lites



TS1201
 2'6" x 6'8"
 2'8" x 6'8"
 2'10" x 6'8"
 3'0" x 6'8"



TS1202
 2'6" x 6'8"
 2'8" x 6'8"
 2'10" x 6'8"
 3'0" x 6'8"



TS1203
 2'6" x 6'8"
 2'8" x 6'8"
 2'10" x 6'8"
 3'0" x 6'8"



TS128
 2'6" x 6'8"
 2'8" x 6'8"
 2'10" x 6'8"
 3'0" x 6'8"



TS1200
 2'6" x 6'8"
 2'8" x 6'8"
 2'10" x 6'8"
 3'0" x 6'8"



TS108
 2'6" x 6'8"
 2'8" x 6'8"
 2'10" x 6'8"
 3'0" x 6'8"



828
 2'6" x 8'0"
 2'8" x 8'0"
 2'10" x 8'0"
 3'0" x 8'0"



808
 2'6" x 8'0"
 2'8" x 8'0"
 2'10" x 8'0"
 3'0" x 8'0"



1201SL
 10" x 6'8"
 12" x 6'8" (7'0")
 14" x 6'8" (7'0")



1202SL
 10" x 6'8"
 12" x 6'8" (7'0")
 14" x 6'8" (7'0")



1200SL
 10" x 6'8"
 12" x 6'8" (7'0")
 14" x 6'8" (7'0")



632SL
 10" x 6'8"
 12" x 6'8" (7'0")
 14" x 6'8" (7'0")



828SL
 12" x 8'0"
 14" x 8'0"



6184SL
 10" x 6'8"
 12" x 6'8" (7'0")
 14" x 6'8" (7'0")



86184SL
 12" x 8'0"
 14" x 8'0"



6185SL
 10" x 6'8"
 12" x 6'8" (7'0")
 14" x 6'8" (7'0")



86185SL
 12" x 8'0"
 14" x 8'0"



6186SL
 10" x 6'8"
 12" x 6'8" (7'0")
 14" x 6'8" (7'0")



86186SL
 12" x 8'0"
 14" x 8'0"

Privacy & Textured Glass Options

Add the code to the blank in the style number for the desired door and glass combination. For details on glass options, see page 232.

XK = Reeded
 XG = Geometric

XE = Satin Etch
 XC = Chord

XJ = Chinchilla
 XR = Rainglass

XN = Granite

*Features a gliding operation and sash locking system.

**Not recommended for use behind storm doors or to be painted dark colors, if exposed to direct sunlight.

Note: See page 299 for important product details that may help with your purchase decision.

Clear Glass



TS198

★♦♦♦♦◆◆◆◆
 2'6" x 6'8"
 2'8" x 6'8"
 2'10" x 6'8"
 3'0" x 6'8"



198SL

★♦♦♦♦◆◆◆◆
 10" x 6'8"
 12" x 6'8" (7'0")
 14" x 6'8" (7'0")



TS118

★♦♦♦◆◆◆◆
 2'0" x 6'8" ▽
 2'4" x 6'8"
 2'6" x 6'8"
 2'8" x 6'8"
 2'10" x 6'8"
 3'0" x 6'8"

818

★♦♦◆◆◆◆
 2'0" x 8'0" ▽
 2'6" x 8'0"
 2'8" x 8'0"
 2'10" x 8'0"
 3'0" x 8'0"



100SL

★◆◆◆◆
 10" x 6'8"
 12" x 6'8" (7'0")
 14" x 6'8" (7'0")

818SL

★◆◆◆◆
 12" x 8'0"
 14" x 8'0"

1/2 Lites

Privacy & Textured

Glass with Divided Lites



TS262_

★
 2'8" x 6'8"
 2'10" x 6'8"
 3'0" x 6'8"



8321_

★
 2'8" x 8'0"
 2'10" x 8'0"
 3'0" x 8'0"



TS263_SL

★
 12" x 6'8"
 14" x 6'8"

Privacy & Textured Glass



TS206_

◆
 2'8" x 6'8"
 2'10" x 6'8"
 3'0" x 6'8"



8206_

◆
 2'8" x 8'0"
 2'10" x 8'0"
 3'0" x 8'0"

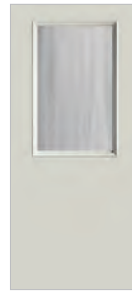

TS104_

◆
 2'8" x 6'8"
 2'10" x 6'8"
 3'0" x 6'8"



TS210_SL

◆
 12" x 6'8"
 14" x 6'8"

Internal Blinds



TS132

◆
 2'6" x 6'8"
 2'8" x 6'8"
 2'10" x 6'8"
 3'0" x 6'8"



8132

◆
 2'8" x 8'0"
 2'10" x 8'0"
 3'0" x 8'0"



TS131

◆◆
 2'6" x 6'8"
 2'8" x 6'8"
 2'10" x 6'8"
 3'0" x 6'8"



TS132SL

◆◆
 12" x 6'8"
 14" x 6'8"

Screen Vented Lites*



TS243

◆
 2'8" x 6'8"
 2'10" x 6'8"
 3'0" x 6'8"

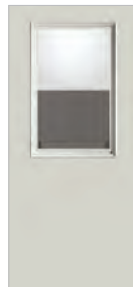

TS137

◆
 2'8" x 6'8"
 2'10" x 6'8"
 3'0" x 6'8"

Key

★ Low-E Glass (LE)

◆ Turtle Glass

◆ Simulated Divided Lites (SDL)

◆ Flat or Contour, White Grilles Between Glass (GBGF / GBGC)

◆ Flat or Contour, Almond Grilles Between Glass (GBGF / GBGC)

◆ Flat or Contour, Bronze Grilles Between Glass (GBGF / GBGC)

◆ Flat or Contour, Black Grilles Between Glass (GBGF / GBGC)

◆ Fixed Grilles (FXG)

◆ NEW Scrolled & Flat Advanta Lite Frame

◆ NEW Scrolled Advanta Lite Frame

◆ WBDL / HVHZ Options

◆ Elevated 10" Bottom Rail Options

◆ PVC Doorlite Frame**

Clear Glass with Divided Lites



8322
 * 6 E
 2'8" x 8'0"
 2'10" x 8'0"
 3'0" x 8'0"



8323
 * 6 E
 2'8" x 8'0"
 2'10" x 8'0"
 3'0" x 8'0"



8324
 * 6 E
 2'8" x 8'0"
 2'10" x 8'0"
 3'0" x 8'0"



TS262
 * 6 E
 2'6" x 6'8"
 2'8" x 6'8"
 2'10" x 6'8"
 3'0" x 6'8"



8321
 * 6 E
 2'8" x 8'0"
 2'10" x 8'0"
 3'0" x 8'0"

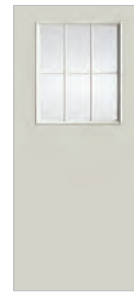

TS115
 * 6 E
 2'6" x 6'8"
 2'8" x 6'8"
 2'10" x 6'8"
 3'0" x 6'8"



TS263SL
 * 6 E
 12" x 6'8"
 14" x 6'8"

Clear Glass



TS1408
 * 6 E
 2'6" x 6'8"
 2'8" x 6'8"
 2'10" x 6'8"
 3'0" x 6'8"



8145
 * 6 E
 2'8" x 8'0"
 2'10" x 8'0"
 3'0" x 8'0"



TS206
 * 6 E
 2'6" x 6'8"
 2'8" x 6'8"
 2'10" x 6'8"
 3'0" x 6'8"

8206
 * 6 E
 2'8" x 8'0"
 2'10" x 8'0"
 3'0" x 8'0"

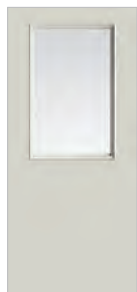

TS104
 * 6 E
 2'6" x 6'8"
 2'8" x 6'8"
 2'10" x 6'8"
 3'0" x 6'8"

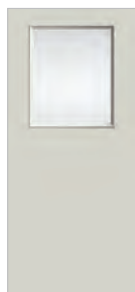

TS105
 * E
 2'6" x 6'8"
 2'8" x 6'8"
 2'10" x 6'8"
 3'0" x 6'8"



TS210SL
 * 6 E
 12" x 6'8"
 14" x 6'8"



Privacy & Textured Glass Options

Add the code to the blank in the style number for the desired door and glass combination. For details on glass options, see page 232.

XK = Reeded
 XG = Geometric

XE = Satin Etch
 XC = Chord

XJ = Chinchilla
 XR = Rainglass

XN = Granite

Note: See page 299 for important product details that may help with your purchase decision.

Bottom: Traditions, Sedona Glass, Door – TS211, Sidelites – 139SL

Right Page: Traditions, Satin Etch Glass, Doors – TS289XE

Twin 1/2 Lites

Privacy & Textured Glass with Divided Lites



TS263_
 2'6" x 6'8"
 2'8" x 6'8"
 2'10" x 6'8"
 3'0" x 6'8"

Privacy & Textured Glass



TS289_
 2'6" x 6'8"
 2'8" x 6'8"
 2'10" x 6'8"
 3'0" x 6'8"

Clear Glass with Divided Lites



TS263
 2'6" x 6'8"
 2'8" x 6'8"
 2'10" x 6'8"
 3'0" x 6'8"



TS1411
 2'6" x 6'8"
 2'8" x 6'8"
 2'10" x 6'8"
 3'0" x 6'8"

Clear Glass



TS289
 2'6" x 6'8"
 2'8" x 6'8"
 2'10" x 6'8"
 3'0" x 6'8"



Minimal Lites

Clear Glass with Divided Lites



TS752
 2'8" x 6'8"
 2'10" x 6'8"
 3'0" x 6'8"



TS704
 2'8" x 6'8"
 2'10" x 6'8"
 3'0" x 6'8"

Clear Glass



TS708
 2'8" x 6'8"
 2'10" x 6'8"
 3'0" x 6'8"



8708
 2'8" x 8'0"
 2'10" x 8'0"
 3'0" x 8'0"

Clear Glass with Divided Lites



TS255
 2'8" x 6'8"
 2'10" x 6'8"
 3'0" x 6'8"

Clear Glass



TS256
 2'8" x 6'8"
 2'10" x 6'8"
 3'0" x 6'8"

Key

- Low-E Glass (LE)
- Simulated Divided Lites (SDL)
- Flat or Contour, White Grilles Between Glass (GBGF / GBGC)
- Flat or Contour, Almond Grilles Between Glass (GBGF / GBGC)
- Flat or Contour, Bronze Grilles Between Glass (GBGF / GBGC)
- Flat or Contour, Black Grilles Between Glass (GBGF / GBGC)
- Fixed Grilles (FXG)
- WBDR / HVHZ Options
- Elevated 10" Bottom Rail Options

Clear Glass with Divided Lites



- | | | |
|---|--|--|
| TS236
◆
2'8" x 6'8"
2'10" x 6'8"
3'0" x 6'8" | 8317
◆
2'8" x 8'0"
2'10" x 8'0"
3'0" x 8'0" | TS237
◆
2'8" x 6'8"
2'10" x 6'8"
3'0" x 6'8"
<small>(Scalloped Lite Frame)</small> |
|---|--|--|

Privacy & Textured Glass



- | | | |
|--|---|--|
| TS296
◆
2'6" x 6'8"
2'8" x 6'8"
2'10" x 6'8"
3'0" x 6'8" | 896
◆
2'8" x 8'0"
2'10" x 8'0"
3'0" x 8'0" | TS296 SL
◆
12" x 6'8"
14" x 6'8" |
|--|---|--|

Clear Glass



- | | | |
|--|---|---|
| TS296
◆
2'6" x 6'8"
2'8" x 6'8"
2'10" x 6'8"
3'0" x 6'8" | 896
◆
2'8" x 8'0"
2'10" x 8'0"
3'0" x 8'0" | TS296SL
◆
12" x 6'8"
14" x 6'8" |
|--|---|---|

Solid Panels

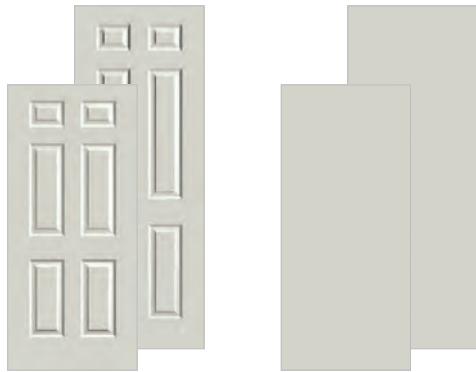

- | | | | |
|--|--|---|---|
| TS210
6
2'6" x 6'8"
2'8" x 6'8"
2'10" x 6'8"
3'0" x 6'8" | 810
6
2'6" x 8'0"
2'8" x 8'0"
2'10" x 8'0"
3'0" x 8'0" | TS100
6E
2'0" x 6'8"
2'4" x 6'8"
2'6" x 6'8"
2'8" x 6'8"
2'10" x 6'8"
3'0" x 6'8" | 800
6E
2'0" x 8'0"
2'4" x 8'0"
2'6" x 8'0"
2'8" x 8'0"
2'10" x 8'0"
3'0" x 8'0" |
|--|--|---|---|

Privacy & Textured Glass Options

Add the code to the blank in the style number for the desired door and glass combination. For details on glass options, see page 232.

XK = Reeded

XG = Geometric

XE = Satin Etch

XC = Chord

XJ = Chinchilla

XR = Rainglass

XN = Granite

Transoms

Transoms can be painted to match a Profiles™ or Traditions door system.

Blackstone ♦ ♦



BSRT
3'0" door + (2) 12" sidelites
Continuous Sill Systems Only

Crystalline ♦ ♦



19080T
3'0" door + (2) 12" sidelites
Continuous Sill Systems Only
3'0" door + (2) 14" sidelites
Continuous / Boxed Sill Systems



19820T
3'0" door + (2) 12" sidelites
3'0" door + (2) 14" sidelites
Continuous / Boxed Sill Systems



19800T
3'0" Door Only



19810T
12" & 14" Sidelite Only

Sedona ♦ ♦



19055T
3'0" door + (2) 12" sidelites
3'0" door + (2) 14" sidelites
Continuous Sill Systems Only



19520T
3'0" door + (2) 12" sidelites
3'0" door + (2) 14" sidelites
Continuous Sill Systems Only

Salinas X



SART
3'0" door + (2) 12" sidelites
Continuous Sill Systems Only

Maple Park ♦ ♦



FWRT
3'0" door + (2) 12" sidelites
3'0" door + (2) 14" sidelites
Continuous Sill Systems Only

Avonlea ♦



AVRT
3'0" door + (2) 12" sidelites
3'0" door + (2) 14" sidelites
Continuous Sill Systems Only

Saratoga ♦ ♦



19750T
3'0" door + (2) 12" sidelites
Continuous Sill Systems Only



19740T
3'0" Door Only

Wellesley ♦ ♦ ♦



19730T
3'0" door + (2) 12" sidelites
Continuous Sill Systems Only



19720T
3'0" Door Only

Riserva X



RSRT
3'0" door + (2) 12" sidelites
Continuous Sill Systems Only

Concorde ♦ ♦ ♦



CNRT
3'0" door + (2) 12" sidelites
3'0" door + (2) 14" sidelites
Continuous Sill Systems Only

Kensington ♦ ♦



KNRT
3'0" door + (2) 12" sidelites
3'0" door + (2) 14" sidelites
Continuous Sill Systems Only

Pembridge ♦ ♦ ♦



PBRT
3'0" door + (2) 12" sidelites
3'0" door + (2) 14" sidelites
Continuous / Boxed Sill Systems

Axis ♦



AXRT
3'0" door + (2) 12" sidelites
3'0" door + (2) 14" sidelites
Continuous / Boxed Sill Systems

Clear Glass



Grille Sticks Applied



19020T
* 3'0" door + (2) 12" sidelites
Continuous Sill Systems Only
3'0" door + (2) 14" sidelites
Continuous / Boxed Sill Systems



Grille Sticks Applied



19220T
* 3'0" door + (2) 12" sidelites
3'0" door + (2) 14" sidelites
Continuous / Boxed Sill Systems



Grille Sticks Applied



19200T
* 3'0" Door Only



19210T
* 12" & 14" Sidelite Only

Key

- ★ Low-E Glass (LE)
- ♦ Black Nickel Caming (1D)
- ♦♦ Brushed Nickel Caming (1C)
- ♦♦♦ Brass Caming (1A)
- X Wrought Iron (1W)
- ♦ Fixed Grilles (FXG)
- 6 WBDR / HVHZ Options
- E Elevated 10" Bottom Rail Options

Fire Doors

Fiber-Classic®, Smooth-Star® & Steel



Intertek

Therma-Tru offers an industry-leading selection of Fire-rated doors certified to carry the Warnock Hersey Mark.

Therma-Tru® Fire-Rated Doors

From smooth to wood-grained, Therma-Tru offers products to meet most national and local code requirements for house-to-garage, multi-family residential and hotel / motel unit entries.* Explore a wide variety of 20-minute Fire-rated fiberglass and steel door styles.

- Fiber-Classic and Smooth-Star 20-minute Fire-rated fiberglass doors are now constructed with a polyurethane foam core that reduces overall door slab weight by 45% for easier handling and installation.**

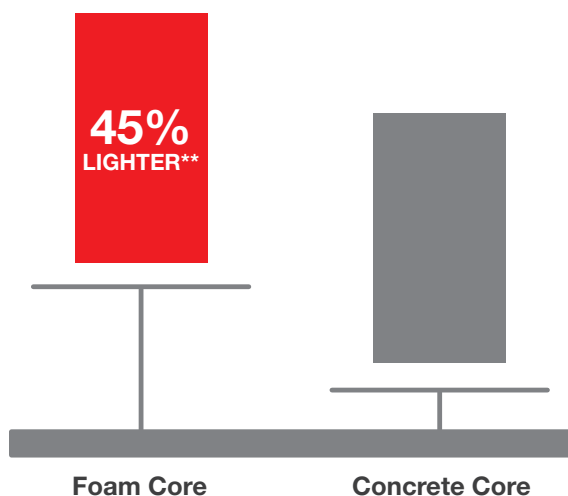

20-Minute Fire-Rated Fiberglass Doors

- Tested to withstand a minimum of 20-minutes of fire exposure with temperatures that reach more than 1,400 degrees Fahrenheit.
- Features a 20-minute positive pressure rating.
- Certified by Intertek, Warnock Hersey for mortise lock use and features a wide lock stile to provide proper handleset reinforcement, combined with lock and hinge stiles that increase rigidity and stability.
- More durable than steel, and resist dents, scratches and rust, making them ideal for high-traffic, heavy-use environments.
- Features full-length lock side blocking, as well as blocking for panic and closure applications.
- Ideal for hotels, apartments, office buildings and other applications with security locks and card readers.

Additional Options

- Solid-panel steel wood-edge doors also available with the 20-minute Fire-rated label, starting on page 258.

For California Projects

Therma-Tru Fiber-Classic and Smooth-Star 20-minute Fire-rated fiberglass doors meet or exceed building codes and regulations specific to the state of California, including:

- ✓ California Wildland Urban Interface (WUI) requirements.
- ✓ California Air Resources Board (CARB) formaldehyde regulations.
- ✓ California State Fire Marshall test CA SFM 12-7A-1.

For Florida Projects

Therma-Tru Fiber-Classic and Smooth-Star foam core 20-minute Fire-rated fiberglass doors include options to meet building codes and regulations specific to the state of Florida.

- ✓ Approved for structural use in Florida.
- ✓ Approved for Wind-Borne Debris Regions (WBDR).

*To confirm fire door requirements in your jurisdiction, always check with your local building code authority.

**Comparison of 20-minute foam core Fire-rated door to a 20-minute concrete core Fire-rated door with similar style.

Note: To see the full results of third-party Intertek, Warnock-Hersey testing, visit www.thermatru.com/performance.

Left: Fiber-Classic Mahogany Collection Door – FMF205, Finish – Driftwood

Adjusta-Fit® 2 Frame



Using the right frame is critical in any top-quality door installation, and never more so than with Fire-rated products. Therma-Tru Adjusta-Fit 2 frame technology helps ensure an optimum fit and long-lasting performance. The frames are constructed with a commercial-grade, 18-gauge base frame; galvanized steel and factory-coated paint finish; and an all-aluminum, thermally broken threshold. These features make them ideal for interior and exterior applications, including corridor openings and outside unit entries.

Therma-Tru® Adjusta-Fit® 2 frames also feature these key benefits:

- 90-Minute positive-pressure Fire-rating, third-party certified by Intertek, Warnock-Hersey.
- Standard 4-7/8" ANSI 115.1, or 2-3/4" T-lip strike prep option.
- Choice of standard, public access or no-sill options.
- Minimum 22-gauge closure with 1" of adjustability, suitable for walls from 4"-9-1/2" deep.

Additional Options

- Therma-Tru composite door frame also 20-minute Fire-rated, starting on page 280.

20-Minute Fire-Rated Wood Edge – Fiberglass



Mahogany
FMF31
2'8" x 6'8"
2'10" x 6'8"
3'0" x 6'8"



Mahogany
FMF220
2'8" x 6'8"
2'10" x 6'8"
3'0" x 6'8"



Mahogany
FMF205
2'8" x 6'8"
2'10" x 6'8"
3'0" x 6'8"



Mahogany
FMF755
2'10" x 6'8"
3'0" x 6'8"



Mahogany
FMF600
2'8" x 6'8"
2'10" x 6'8"
3'0" x 6'8"



Mahogany
FMF134
2'10" x 6'8"
3'0" x 6'8"



Mahogany
FMF60
2'8" x 6'8"
2'10" x 6'8"
3'0" x 6'8"



Mahogany
FMF860
2'8" x 8'0"
3'0" x 8'0"



Mahogany
FMF100
2'6" x 6'8"
2'8" x 6'8" (7'0")
2'10" x 6'8"
3'0" x 6'8" (7'0")



Mahogany
FMF8100
2'6" x 8'0"
2'8" x 8'0"
2'10" x 8'0"
3'0" x 8'0"



Oak
FCF31
2'8" x 6'8"
3'0" x 6'8"



Oak
FCF809
2'8" x 6'8"
2'10" x 6'8"
3'0" x 6'8"

Note: See page 299 for important product details that may help with your purchase decision.

Right Page, Left: Profiles Door – 203HD

Right Page, Right: Smooth-Star Door – SSF220







										
Oak	Oak	Oak	Oak	Oak	Oak	Smooth	Smooth	Smooth		
FCF755 9 2'10" x 6'8" 3'0" x 6'8"	FCF862 9 2'8" x 8'0" 2'10" x 8'0" 3'0" x 8'0"	FCF160 9 E 2'6" x 6'8" 2'8" x 6'8" (7'0") 2'10" x 6'8" (7'0") 3'0" x 6'8" (7'0")	FCF8160 9 2'8" x 8'0" 2'10" x 8'0" 3'0" x 8'0"	FCF100 9 E 2'6" x 6'8" 2'8" x 6'8" (7'0") 2'10" x 6'8" 3'0" x 6'8" (7'0")	FCF8100 9 E 2'6" x 8'0" 2'8" x 8'0" 2'10" x 8'0" 3'0" x 8'0"	SSF93 9 2'8" x 6'8" 2'10" x 6'8" 3'0" x 6'8"	SSF220 9 E 2'8" x 6'8" (7'0") 2'10" x 6'8" (7'0") 3'0" x 6'8" (7'0")	SSF8220 9 E 2'8" x 8'0" 2'10" x 8'0" 3'0" x 8'0"		
										
Smooth	Smooth	Smooth	Smooth	Smooth	Smooth	Smooth	Smooth	Smooth	Smooth	Smooth
SSF1100 9 E 2'8" x 6'8" 2'10" x 6'8" 3'0" x 6'8"	SSF81100 9 2'8" x 8'0" 2'10" x 8'0" 3'0" x 8'0"	SSF120 9 E 2'8" x 6'8" 2'10" x 6'8" 3'0" x 6'8"	SSF8120 9 2'8" x 8'0" 2'10" x 8'0" 3'0" x 8'0"	SSF200 9 2'6" x 6'8" 2'8" x 6'8" 2'10" x 6'8" 3'0" x 6'8"	SSF8200 9 2'8" x 8'0" 2'10" x 8'0" 3'0" x 8'0"	SSF205 9 2'8" x 6'8" 2'10" x 6'8" 3'0" x 6'8"	SSF8205 9 2'8" x 8'0" 2'10" x 8'0" 3'0" x 8'0"	SSF755 9 2'10" x 6'8" 3'0" x 6'8"	SSF31 9 2'8" x 6'8" 2'10" x 6'8" 3'0" x 6'8"	SSF831 9 2'8" x 8'0" 2'10" x 8'0" 3'0" x 8'0"

Key

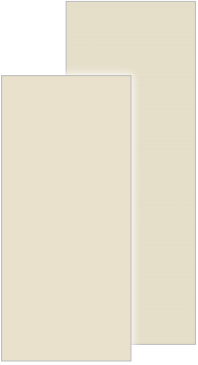

- No Stile Lines
- E Elevated 10" Bottom Rail Options
- 9 WBDR Options

20-Minute Fire-Rated Wood Edge – Fiberglass *Continued*

									
Smooth	Smooth	Smooth	Smooth	Smooth	Smooth				
SSF960 6 2'8" x 6'8" 2'10" x 6'8" 3'0" x 6'8"	SSF4800 6 E 2'8" x 6'8" 2'10" x 6'8" 3'0" x 6'8"	SSF84800 6 2'8" x 8'0" 2'10" x 8'0" 3'0" x 8'0"	SSF600 6 2'8" x 6'8" 2'10" x 6'8" 3'0" x 6'8"	SSF8600 6 2'8" x 8'0" 2'10" x 8'0" 3'0" x 8'0"	SSF11 6 2'10" x 6'8" 3'0" x 6'8"	SSF160 6 E 2'6" x 6'8" 2'8" x 6'8" (7'0") 2'10" x 6'8" (7'0") 3'0" x 6'8" (7'0")	SSF8160 6 2'6" x 8'0" 2'8" x 8'0" 2'10" x 8'0" 3'0" x 8'0"	SSF100 6 E 2'0" x 6'8" 2'4" x 6'8" 2'6" x 6'8" 2'8" x 6'8" (7'0") 2'10" x 6'8" (7'0") 3'0" x 6'8" (7'0")	SSF8100 6 E 2'6" x 8'0" 2'8" x 8'0" 2'10" x 8'0" 3'0" x 8'0"

20-Minute Fire-Rated Wood Edge – Steel

Profiles™

						
969HD 6 2'8" x 6'8" 2'10" x 6'8" 3'0" x 6'8"	978HD 6 2'8" x 6'8" 2'10" x 6'8" 3'0" x 6'8"	1005HD 6 2'8" x 6'8" 2'10" x 6'8" 3'0" x 6'8"	205HD 6 2'8" x 6'8" 2'10" x 6'8" 3'0" x 6'8"	203HD 6 2'8" x 6'8" 2'10" x 6'8" 3'0" x 6'8"	210HD 6 2'6" x 6'8" (7'0") 2'8" x 6'8" (7'0") 2'10" x 6'8" (7'0") 3'0" x 6'8" (7'0")	100 6 E 2'0" x 6'8" 2'4" x 6'8" 2'6" x 6'8" (7'0") 2'8" x 6'8" (7'0") 2'10" x 6'8" (7'0") 3'0" x 6'8" (7'0") 3'6" x 6'8"

Traditions

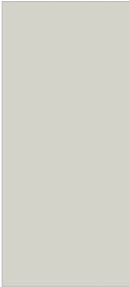
	
TS210 6 2'6" x 6'8" 2'8" x 6'8" 2'10" x 6'8" 3'0" x 6'8"	TS100 6 E 2'0" x 6'8" 2'4" x 6'8" 2'6" x 6'8" 2'8" x 6'8" 2'10" x 6'8" 3'0" x 6'8"

Key

- No Stile Lines
- Elevated 10" Bottom Rail Options
-  WBDR Options
-  WBDR / HVHZ Options

Note: See page 299 for important product details that may help with your purchase decision.
Right Page: Smooth-Star Door – SSF120





Modern design. Upbeat living.

Pulse®



Clean lines. Crisp angles. Sleek designs. Vintage style. Pulse is a contemporary series of door styles and glass designs that can be combined to make a bold statement. With three distinct aesthetic approaches – Ari, Línea and Echo – the entrance becomes modern art.

*Please verify that there is a Therma-Tru Impact-rated product approval for the configuration before buying. Note: Finish colors may vary from an actual application due to fluctuations in finishing or printing. Glass designs may differ from depiction due to size and hand craftsmanship of glass. See your Therma-Tru seller or visit www.thermatru.com for more, including details on limited warranties and exclusions, ENERGY STAR qualified products and product approvals.

It's your decision, by design.

Pulse is geometry with energy. Designed to be fun and easy to mix and match with sleek, flush door and sidelite styles, you can create a modern entrance without missing a beat. Explore all the possible combinations at thermatru.com/pulse. Mix and match to get the style numbers needed to order. Turn the page for a glimpse of available styles and sizes.



The creativity is unlimited. Stain or paint the entrance any color.

These doors and sidelites come ready to stain or paint. So there's no limit to the creativity you can use when it comes to finishing touches.



WBDR / HVHZ Options: Look for this icon to find door styles that can be configured for WBDR or HVHZ.*

1 Start with a STYLE.

Combine doors and sidelites to create an entrance that fits your vision.

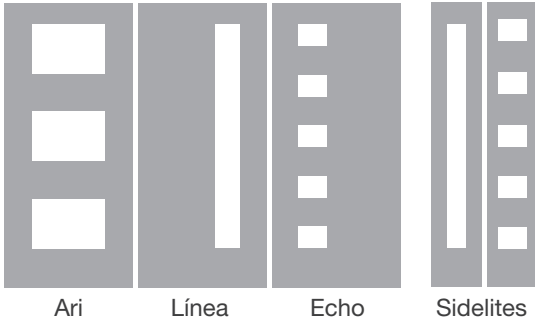

2 Choose a MATERIAL.

Each style is available in any of these material choices.



3 Select a GLASS.

Find an available glass design to complete the statement you want to make.

Privacy & Textured Glass

Available for all Pulse door styles.



Low-E Also Available.

Decorative Glass

Available for Línea.

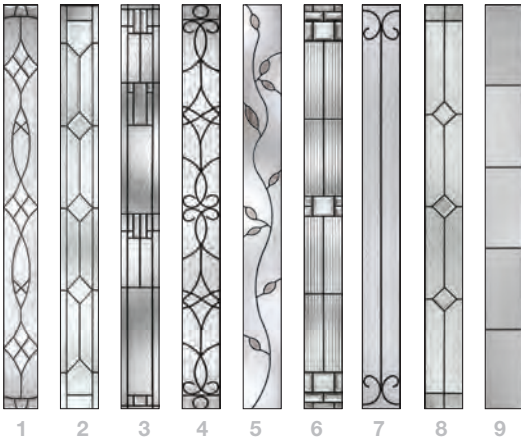

Available for Ari.

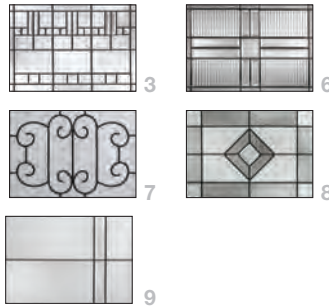

Available for Echo.



- 1 Blackstone®
- 2 Crystalline™
- 3 Sedona
- 4 Salinas®
- 5 Avonlea®
- 6 Saratoga™
- 7 Riserva®
- 8 Pembridge™
- 9 Axis®

4 Then select a FRAME.

Choose the flat profile for modern appeal or scrolled profile for vintage style.



Flat Profile Lite Frame

Scrolled Profile Lite Frame

Pulse® Size Options

	Wood-Grained Fiberglass		Smooth Fiberglass		Steel	
	6'8"	8'0"	6'8"	8'0"	6'8"	8'0"
Doors	2'6" x 6'8" ◦	2'6" x 8'0" ◦	2'6" x 6'8" ◦	2'6" x 8'0" ◦	2'6" x 6'8" ◦	2'6" x 8'0" ◦
	2'8" x 6'8"	2'8" x 8'0"	2'8" x 6'8"	2'8" x 8'0"	2'8" x 6'8"	2'8" x 8'0"
	2'10" x 6'8"	2'10" x 8'0"	2'10" x 6'8"	2'10" x 8'0"	2'10" x 6'8"	2'10" x 8'0"
	3'0" x 6'8"	3'0" x 8'0"	3'0" x 6'8"	3'0" x 8'0"	3'0" x 6'8"	3'0" x 8'0"
			3'6" x 6'8"	3'6" x 8'0"	3'6" x 6'8"	
Sidelites	10" x 6'8" •	12" x 8'0"	10" x 6'8" •	12" x 8'0"	10" x 6'8" •	12" x 8'0"
	12" x 6'8"	14" x 8'0"	12" x 6'8"	14" x 8'0"	12" x 6'8"	14" x 8'0"
	14" x 6'8"		14" x 6'8"		14" x 6'8"	

- Available in full-lite sidelites only.
- Available in Línea and Echo only.



Ari

Note: Product images show exterior side of door.

Pulse®

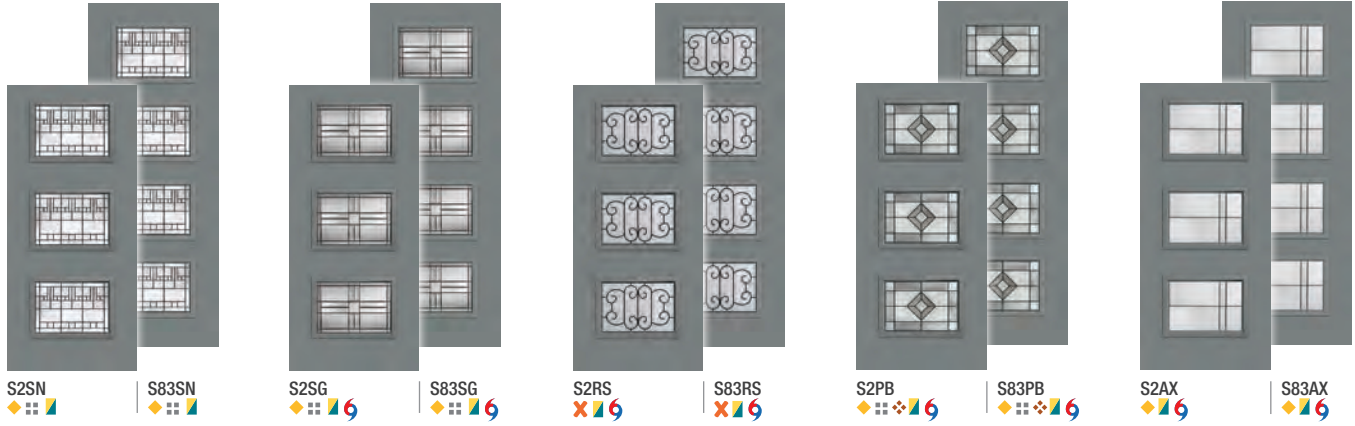

Línea

Note: Product images show exterior side of door.

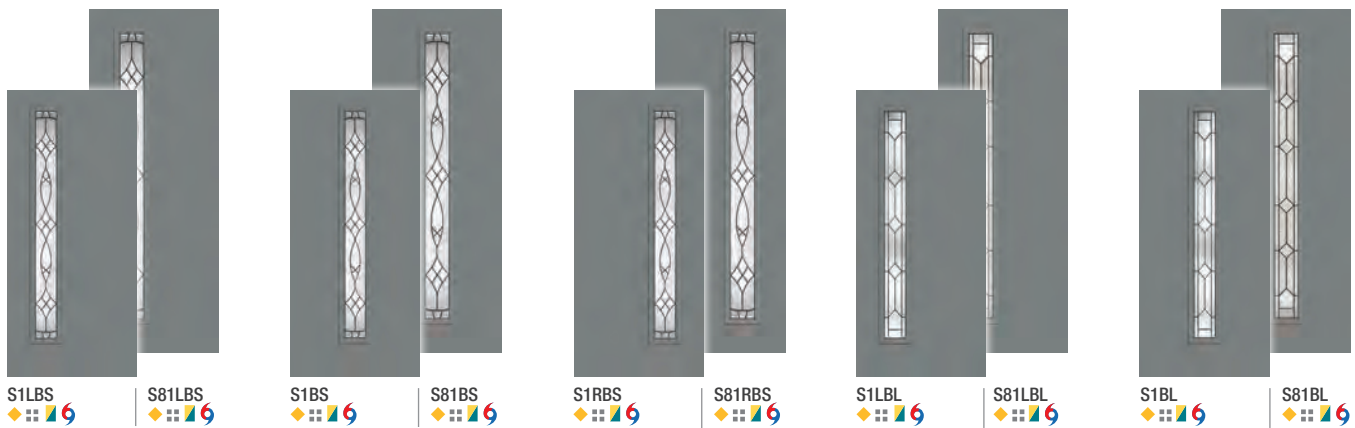

			<p>It's your decision, by design.</p> <p>Select a look for the door and sidelites. Choose a material. Find an available glass design and frame to complete the statement. Stain or paint it any color. Explore all the possible combinations at thermatru.com/pulse.</p>
Wood-Grained Fiberglass: Mahogany or Oak (Shown in Driftwood stain.)	Smooth Fiberglass	Steel	

Note: Door and sidelite styles shown in smooth fiberglass with flat lite frame. To see styles in other material choices, go to thermatru.com/pulse.

Note: See page 299 for important product details that may help with your purchase decision.
Top: Pulse Ari, Axis Glass with Scrolled Lite Frame, Door – S83AX, ©TheHouseDesigners.com

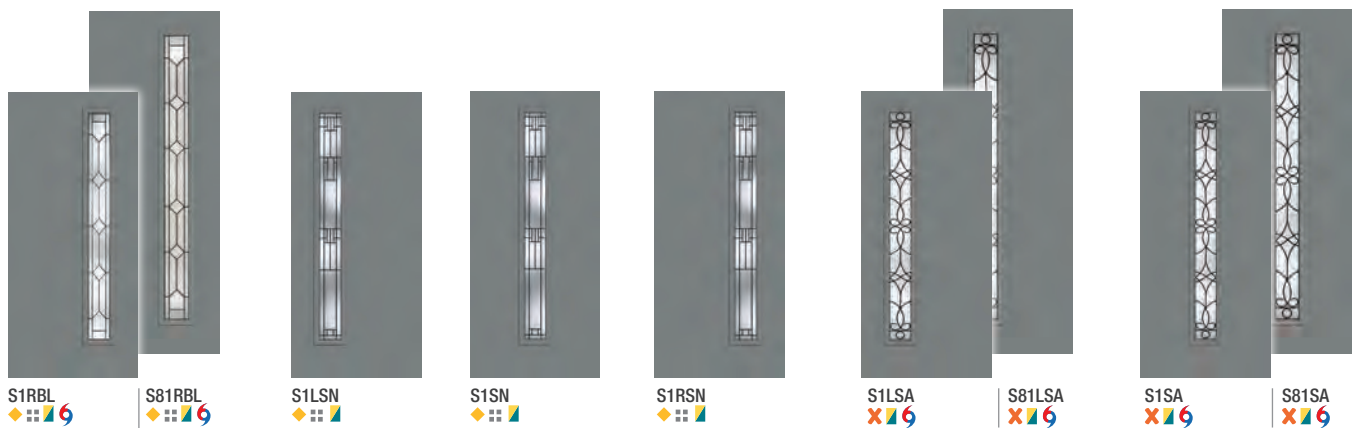

S1RBL | S81RBL

S1LSN | S1SN | S1RSN | S1LSA | S81LSA | S1SA | S81SA

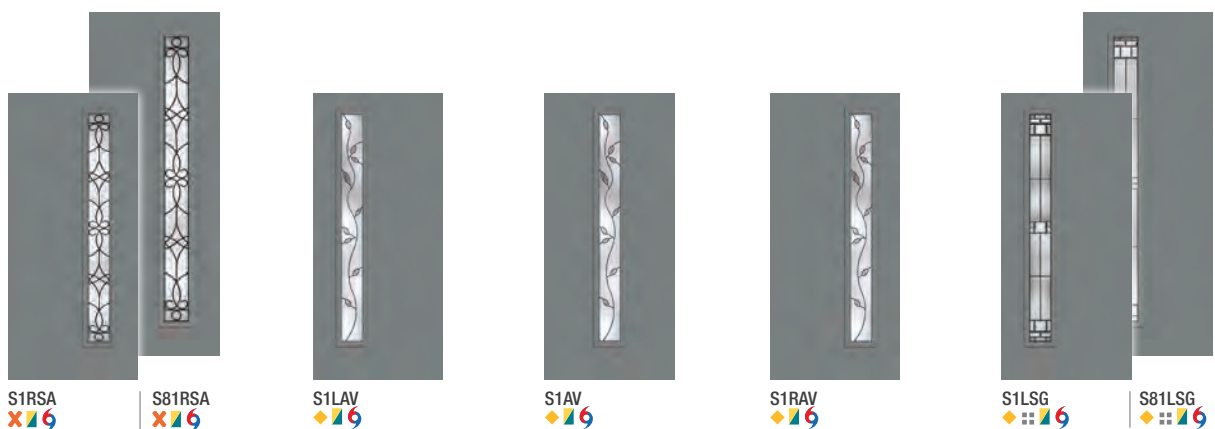

S1RSA | S81RSA | S1LAV | S1AV | S1RAV | S1LSG | S81LSG

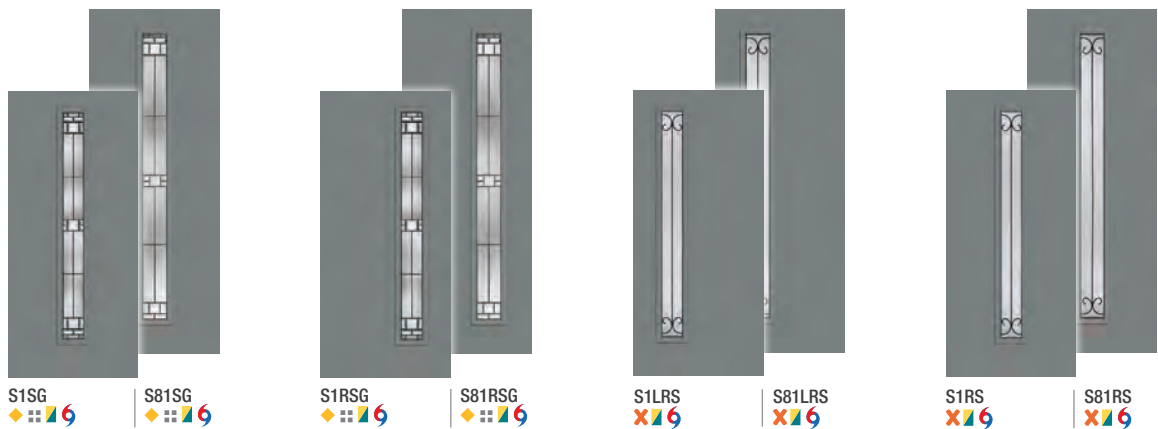

S1SG | S81SG | S1RSG | S81RSG | S1LRS | S81LRS | S1RS | S81RS

Línea Continues on next page.

Privacy & Textured Glass Options
 Add the code to the blank in the style number for the desired door and glass combination. For details on glass options, see page 262.

XK = Reeded XE = Satin Etch XJ = Chinchilla XN = Granite
 XG = Geometric XC = Chord XR = Rainglass

- Key**
- Low-E Glass (LE)
 - Black Nickel Caming (1D)
 - Brushed Nickel Caming (1C)
 - Brass Caming (1A)
 - Wrought Iron (1W)
 - NEW Scrolled & Flat Advanta Lite Frame
 - WBDR / HVHZ Options

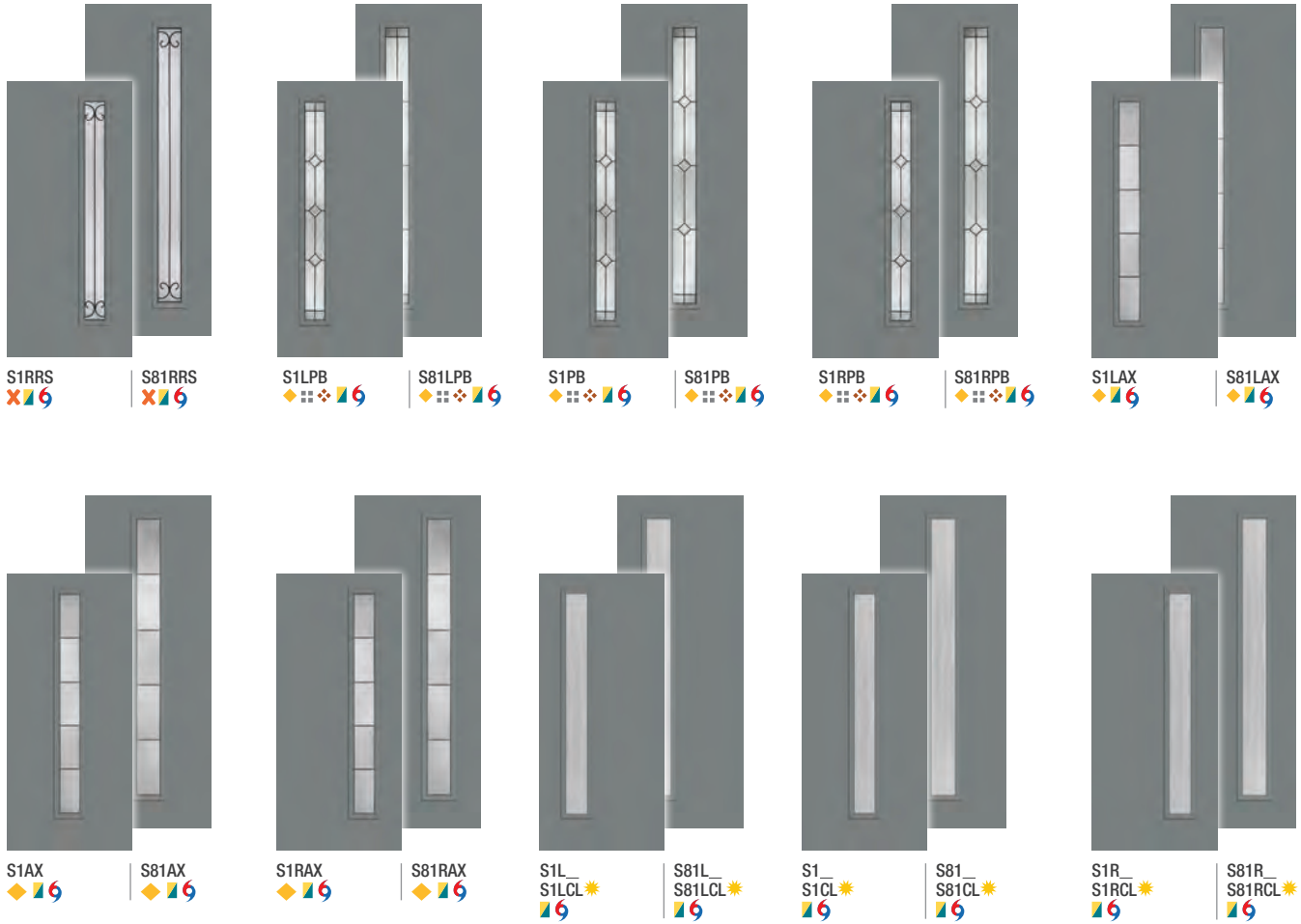

Echo

Note: Product images show exterior side of door.



		
Wood-Grained Fiberglass: Mahogany or Oak (Shown in Driftwood stain.)	Smooth Fiberglass	Steel

It's your decision, by design.
 Select a look for the door and sidelites. Choose a material. Find an available glass design and frame to complete the statement. Stain or paint it any color. Explore all the possible combinations at thermatru.com/pulse.

Note: Door and sidelite styles shown in smooth fiberglass with flat lite frame. To see styles in other material choices, go to thermatru.com/pulse.



S5PB S85PB S5RPB S85RPB S86LPB S86PB S86RPB



S9LPB S9PB S9RPB S8LPB S8PB S8RPB



S811LPB S811PB S811RPB S810LPB S810PB S810RPB

Echo *Continues on next page.*

Privacy & Textured Glass Options
 Add the code to the blank in the style number for the desired door and glass combination. For details on glass options, see page 262.

XK = Reeded	XE = Satin Etch	XJ = Chinchilla	XN = Granite
XG = Geometric	XC = Chord	XR = Rainglass	

Key

Low-E Glass (LE)	Brass Caming (1A)	WBDR / HVHZ Options
Black Nickel Caming (1D)	Wrought Iron (1W)	Elevated 10" Bottom Rail Options
Brushed Nickel Caming (1C)	NEW Scrolled & Flat Advanta Lite Frame	

Pulse®



S4LAX | S84LAX



S4AX | S84AX

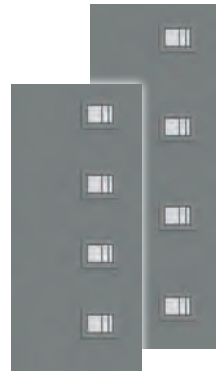

S4RAX | S84RAX

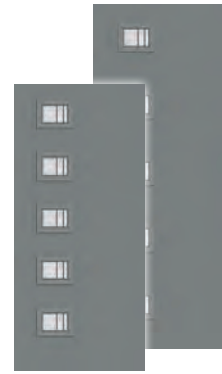

S5LAX | S85LAX



S5AX | S85AX

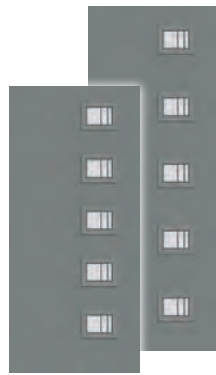

S5RAX | S85RAX



S86LAX



S86AX



S86RAX



S9LAX
◆ E



S9AX
◆ E



S9RAX
◆ E



S8LAX
◆ E



S8AX
◆ E

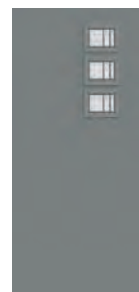

S8RAX
◆ E

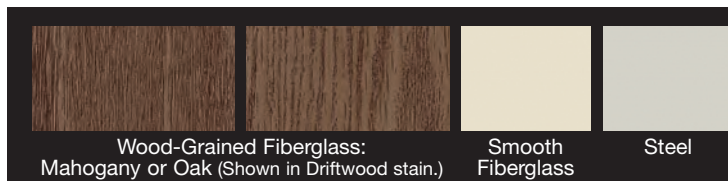

Wood-Grained Fiberglass:
Mahogany or Oak (Shown in Driftwood stain.)

Smooth
Fiberglass

Steel

It's your decision, by design.

Select a look for the door and sidelites. Choose a material. Find an available glass design and frame to complete the statement. Stain or paint it any color. Explore all the possible combinations at thermatru.com/pulse.

Note: Door and sidelite styles shown in smooth fiberglass with flat lite frame. To see styles in other material choices, go to thermatru.com/pulse.



S811LAX
◆ E



S811AX
◆ E



S811RAX
◆ E



S810LAX
◆ E



S810AX
◆ E



S810RAX
◆ E



S4L_ S4LCL ✨ | S84L_ S84LCL ✨

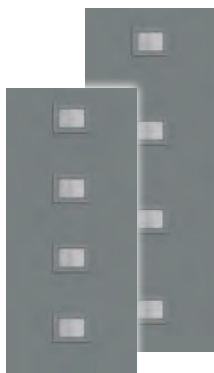

S4_ S4CL ✨ | S84_ S84CL ✨

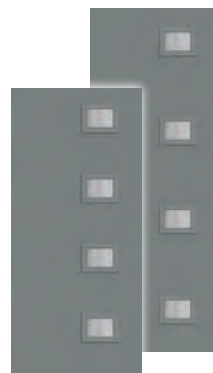

S4R_ S4RCL ✨ | S84R_ S84RCL ✨

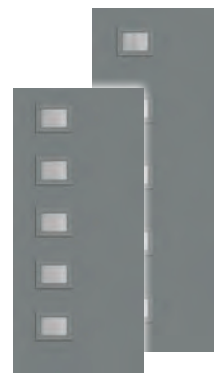

S5L_ S5LCL ✨ | S85L_ S85LCL ✨



S5_ S5CL ✨ | S85_ S85CL ✨

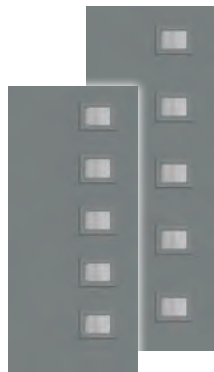

S5R_ S5RCL ✨ | S85R_ S85RCL ✨



S86L_ S86LCL ✨



S86_ S86CL ✨



S86R_ S86RCL ✨

Echo *Continues on next page.*

Privacy & Textured Glass Options

Add the code to the blank in the style number for the desired door and glass combination. For details on glass options, see page 262.

XK = Reeded

XG = Geometric

XE = Satin Etch

XC = Chord

XJ = Chinchilla

XR = Rainglass

XN = Granite

Key

✨ Low-E Glass (LE)

◆ Black Nickel Caming (1D)

E Elevated 10" Bottom Rail Options



S9L_ S9LCL ✨
E



S9_ S9CL ✨
E



S9R_ S9RCL ✨
E



S8L_ S8LCL ✨
E



S8_ S8CL ✨
E



S8R_ S8RCL ✨
E



S811L_ S811LCL ✨
E



S811_ S811CL ✨
E



S811R_ S811RCL ✨
E



S810L_ S810LCL ✨
E



S810_ S810CL ✨
E

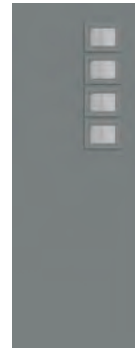

S810R_ S810RCL ✨
E



It's your decision, by design.

Select a look for the door and sidelites. Choose a material. Find an available glass design and frame to complete the statement. Stain or paint it any color. Explore all the possible combinations at thermatru.com/pulse.

Note: Door and sidelite styles shown in smooth fiberglass with flat lite frame. To see styles in other material choices, go to thermatru.com/pulse.

Note: See page 299 for important product details that may help with your purchase decision.

Top: Pulse Echo, Low-E Glass with Flat Lite Frame, Door – S85CL

Sidelites

Note: Product images show exterior side of door.

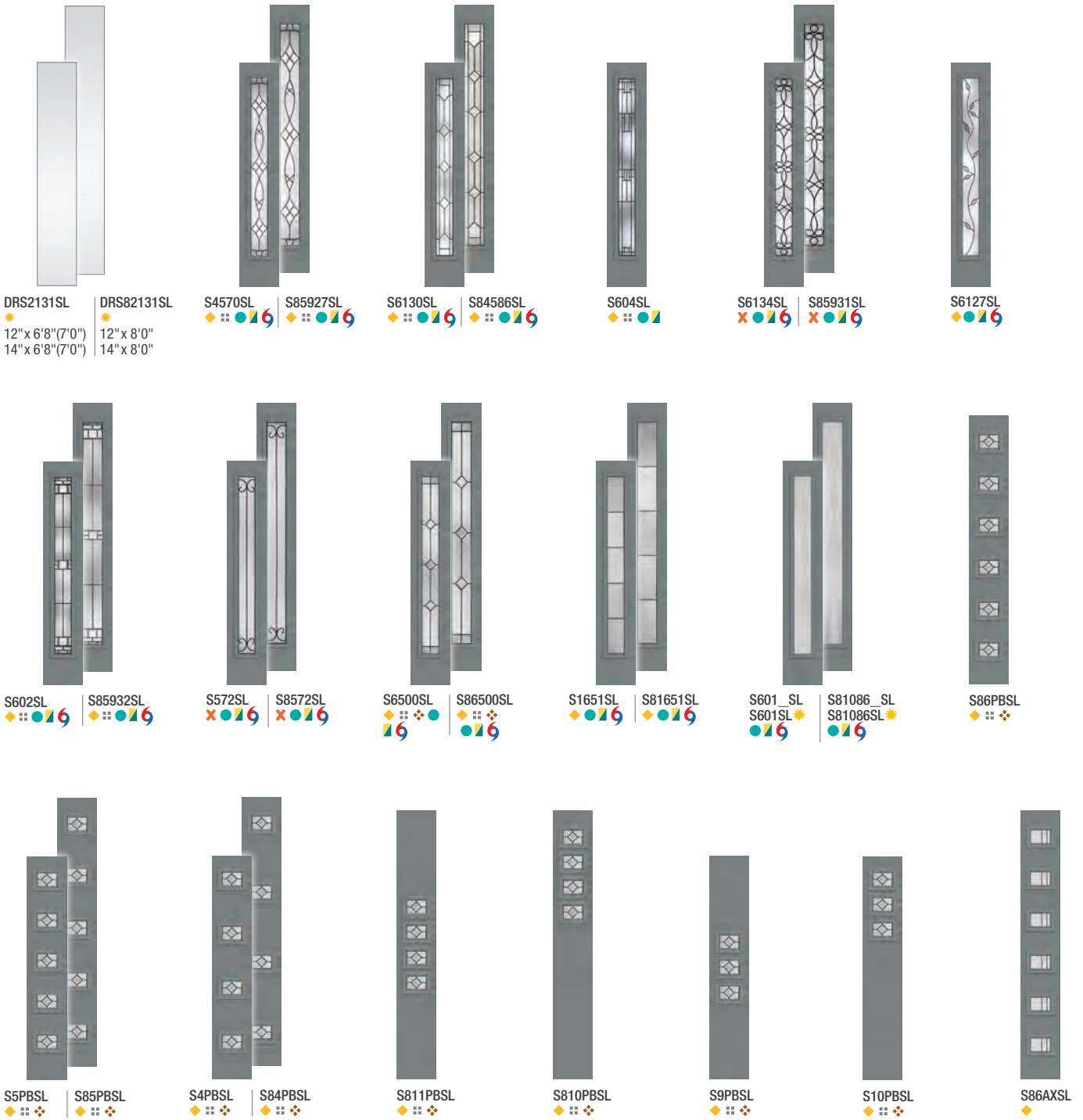

Sidelites *Continue on next page.*

Privacy & Textured Glass Options
 Add the code to the blank in the style number for the desired door and glass combination. For details on glass options, see page 262.

XK = Reeded	XE = Satin Etch	XJ = Chinchilla	XN = Granite
XG = Geometric	XC = Chord	XR = Rainglass	

Key

★ Low-E Glass (LE)	✕ Wrought Iron (1W)	Ⓞ WBDR / HVHZ Options
◆ Black Nickel Caming (1D)	● Vented Sidelite Options	ⓔ Elevated 10" Bottom Rail Options
■ Brushed Nickel Caming (1C)	▬ NEW Scrolled & Flat Advanta Lite Frame	
◆ Brass Caming (1A)		

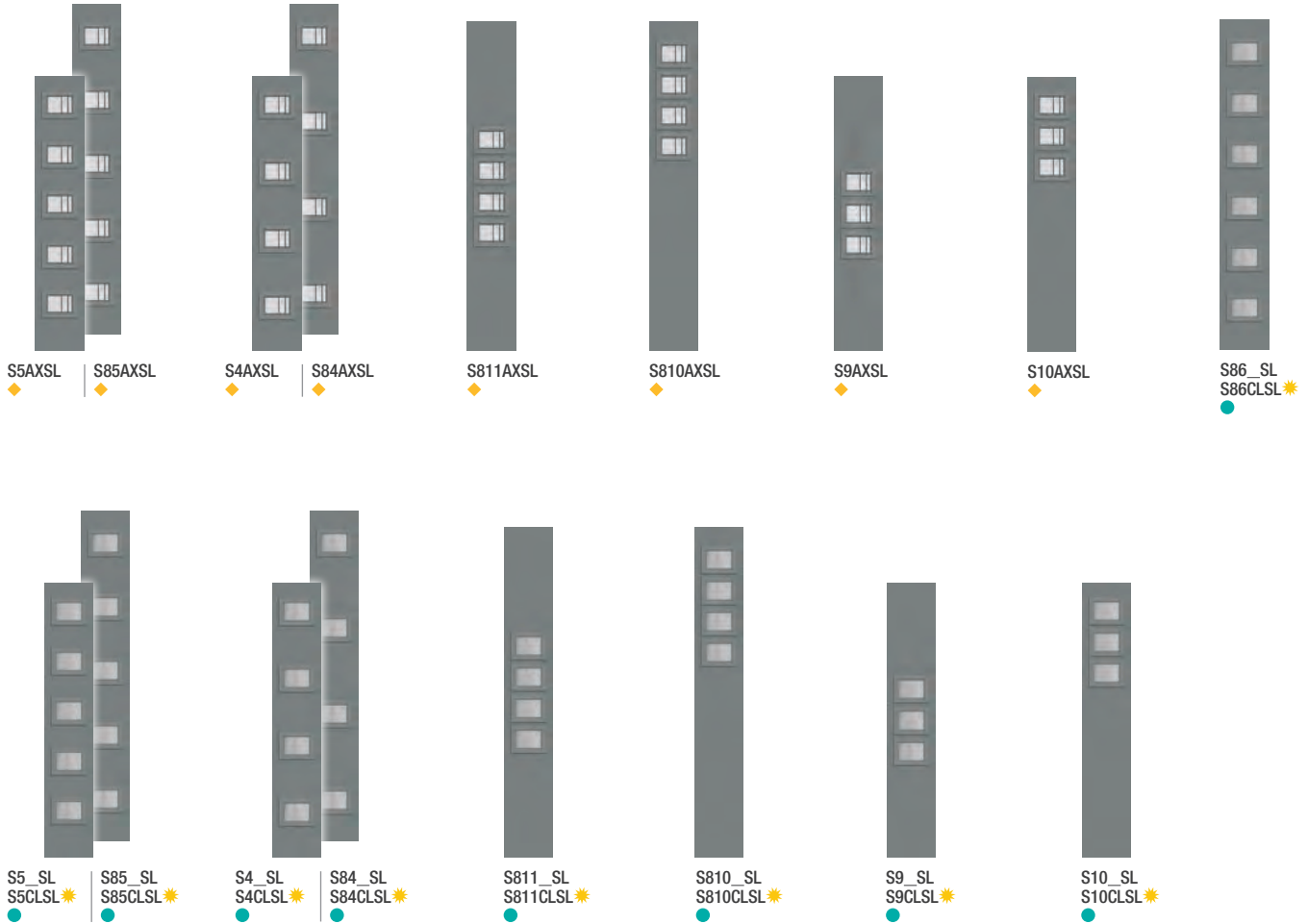

Privacy & Textured Glass Options
 Add the code to the blank in the style number for the desired door and glass combination. For details on glass options, see page 262.

XK = Reeded	XJ = Chinchilla
XG = Geometric	XR = Rainglass
XE = Satin Etch	XN = Granite
XC = Chord	

Key

- Low-E Glass (LE)
- Black Nickel Caming (1D)
- Vented Sidelite Options

Wood-Grained Fiberglass: Mahogany or Oak (Shown in Driftwood stain.)	Smooth Fiberglass	Steel

It's your decision, by design.
 Select a look for the door and sidelites. Choose a material. Find an available glass design and frame to complete the statement. Stain or paint it any color. Explore all the possible combinations at thermatru.com/pulse.

Note: Door and sidelite styles shown in smooth fiberglass with flat lite frame. To see styles in other material choices, go to thermatru.com/pulse.

Note: See page 299 for important product details that may help with your purchase decision.
 Right Page, Top: Pulse Línea, Low-E Glass with Flat Lite Frame, Door – S81RCL, Direct Set Sidelite – DRS82131SL, Finish – Chestnut
 Right Page, Bottom: Pulse Echo, Geometric Glass with Flat Lite Frame, Door – S9XG, Sidelite – S9XGSL



Finishing Options

Finishing Options



Add Curb Appeal with Color

Stain and paint can make all the difference when it comes to a home's curb appeal. Find inspiration and explore professionally applied premium stains and paints, as well as options for in-field applications.

Note: Finish colors may vary from an actual application due to fluctuations in finishing or printing. See page 299 for important product details that may help with your purchase decision. See your Therma-Tru seller for details on the PrismaGuard limited warranty and exclusions.



Finished for Lasting Beauty

Handcrafted and professionally applied in a controlled environment, a PrismaGuard® premium finish is built to last, giving your customers confidence and peace of mind.

- Designed for optimal performance with Therma-Tru® fiberglass doors and composite door frames.
- Features enhanced durability to protect from everyday wear and tear.
- Backed by a 10-year limited finish warranty. For Classic Craft® doors, the balance of this warranty can transfer to a second owner.
- Enhances the overall beauty of the entry with a nature-inspired color palette of premium stains and paints.

10 YEAR
LIMITED
WARRANTY
TRANSFERABLE
Classic Craft

10 YEAR
LIMITED
WARRANTY



Durable
Topcoat



Professional
Application



Tested to meet tough expectations.

PrismaGuard premium finish undergoes rigorous testing with specialized equipment to help ensure it delivers a consistent high-end appearance with a low-maintenance coating that preserves the door's color for years to come.



PrismaGuard® Premium Stain

Bring the authentic look of wood to life with rich tones that add dimension and are designed to enhance the wood grains of Therma-Tru® fiberglass doors and composite door frames.

- 1 It starts with the realistic wood grains and deep embossments of a Therma-Tru® door or composite door frame.
- 2 A base coat provides an even, consistent color across the surface.
- 3 A wiping stain enhances the base coat while adding dimension to reflect the natural beauty of wood.
- 4 A durable topcoat enhances the high-definition color while protecting against scratches and color fading.
- 5 A second application of the topcoat provides added durability and optimal sheen for a high-end look.



Shown on Classic Craft Fir Grain.



Wildflower Honey



Rustic Clay

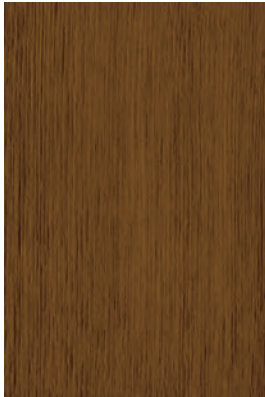

Barley

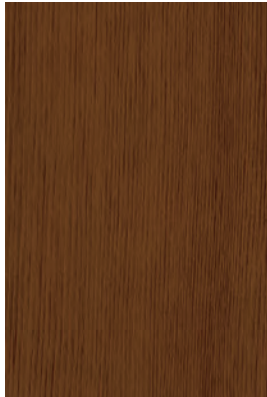

New Earth



Autumn Harvest



Redwood

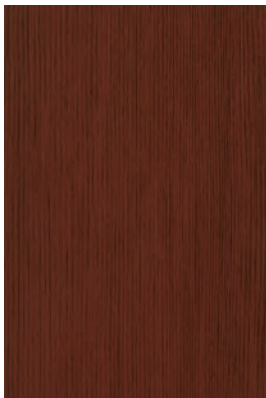

Mulberry

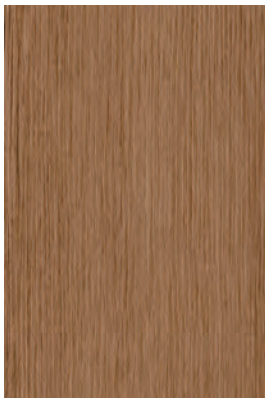

Acorn

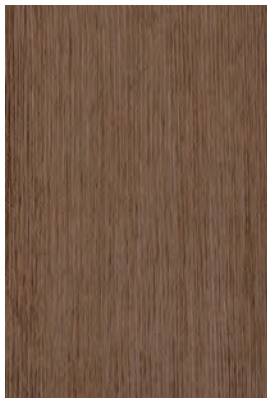

Driftwood



Raven

Note: Finish colors may vary from an actual application due to fluctuations in finishing or printing. See page 299 for important product details that may help with your purchase decision. See your Therma-Tru seller for details on the PrismaGuard limited warranty and exclusions.

PrismaGuard® Premium Paint

Add a pop of color to Therma-Tru® doors and composite door frames, and tailor the look of the entry to make a beautiful lasting impression.

- 1 It starts with the smooth or wood-grained surface of a Therma-Tru® door or composite door frame.
- 2 A base coat provides an even, consistent color across the surface.
- 3 A durable topcoat enhances the high-definition color while protecting against scratches and color fading.
- 4 A second application of the topcoat provides added durability and optimal sheen for a high-end look.

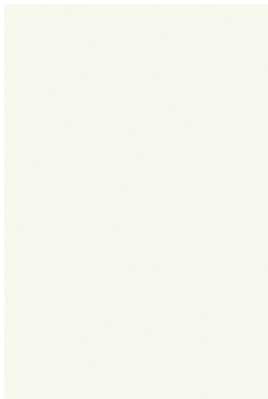

Alpine



Cypress



Granite



Ruby Red

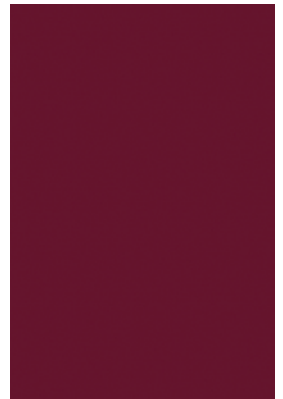

Cabernet



Indigo

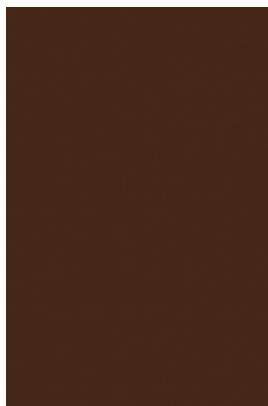

Chestnut

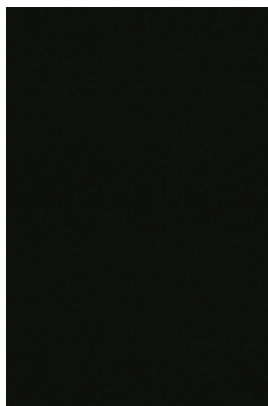

Onyx



Order 4" x 4" samples of select PrismaGuard finish colors at store.thermatru.com.

SAME-DAY STAIN

Create the authentic look of real wood in just a few simple steps.

- Achieve professional-looking results with an easy-to-use, quick-drying formula.
- Colorfast stain resists fading, bleaching and yellowing to create a beautiful finish.
- Finish colors can be applied in a variety of shades to complement multiple home styles.
- Specially formulated for Therma-Tru® fiberglass doors and composite door frames.

Shown on Classic Craft Fir Grain.

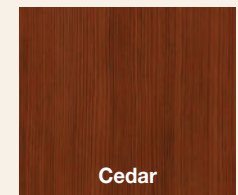
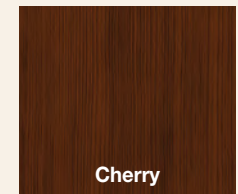
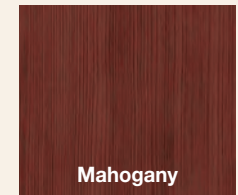
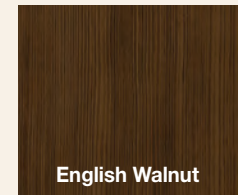
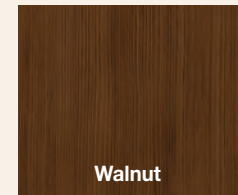
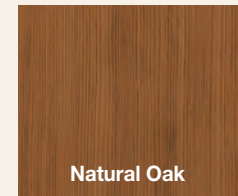
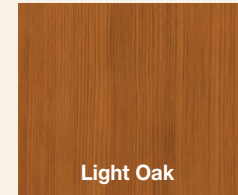

All-Inclusive Kit

Contains everything needed to stain a Therma-Tru fiberglass double door system or a single door with two sidelites.*

Watch easy-to-follow instructions at thermatru.com/samedaystain.



5 YEAR LIMITED WARRANTY For complete details on the Same-Day Stain and topcoat limited warranty, go to thermatru.com/finishing or ask your seller for more details.

*Actual coverage may vary based on product selected, application method and desired appearance. Note: Finish colors may vary from an actual application due to fluctuations in finishing or printing. See page 299 for important product details that may help with your purchase decision. See your Therma-Tru seller for details on the Same-Day Stain limited warranty and exclusions.

Door System Components

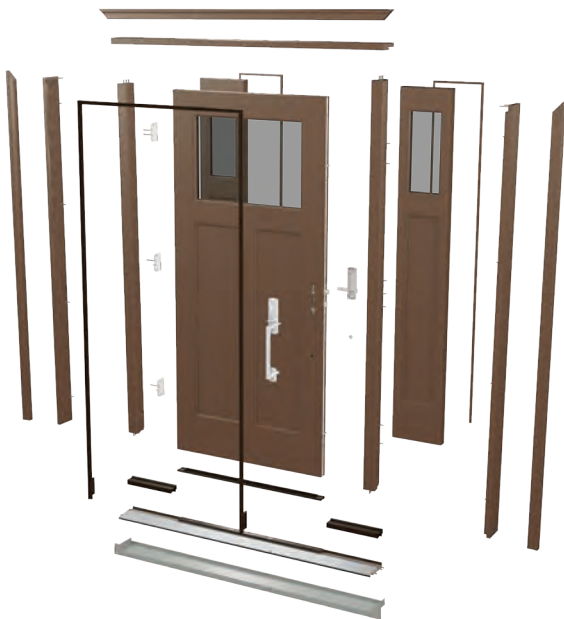

Engineered to work together.

A Therma-Tru® door with genuine Therma-Tru components is more than a beautiful door – it's a complete door system engineered with craftsman precision for durability and reliability through the years. And, a Therma-Tru fiberglass door system with genuine Therma-Tru components is backed by the industry's most comprehensive lifetime limited warranty.

Visit our online replacement parts page to maintain the integrity of a complete door system with genuine Therma-Tru components at thermatru.com/parts.

Composite Door Frame*

featuring Tru-Guard™ Composite Technology



TRU  **GUARD**[™]
COMPOSITE TECHNOLOGY

Composite door frame featuring Tru-Guard™ composite technology provides a rot-free solution engineered to work together with rot-resistant Therma-Tru doors and components.

- Delivers extra protection from the damaging effects of outside elements for peace of mind.
- Eliminates the risk of rot and wood-ingesting insects with a durable composite material that is virtually maintenance free. Rot-free door frame does not absorb moisture and resists mold, mildew and fungus.

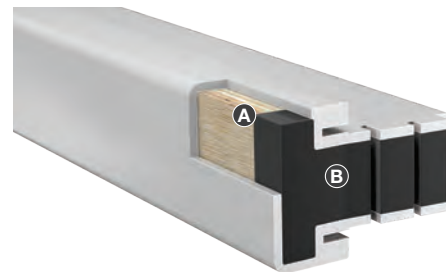

Reinforced Mullions

Provide additional structural support and stability. All mullions are reinforced with a co-extruded **A** LVL core to provide additional structural support and stability and feature a **B** composite-capped bottom to eliminate the risk of water absorption and maintain a rot-free composite exterior.

Order composite door frame samples at store.thermatru.com.

*See your Therma-Tru seller for details on product availability.

**Comparison of pendulum impact test results for Therma-Tru composite door frame and standard finger-jointed Pine wood door frame, both with similar pre-hung doors.

***To confirm code requirements in your jurisdiction, always check with your local building code authority.

Note: See your Therma-Tru seller or visit www.thermatru.com for details on available product sizes and options, limited warranties and exclusions, and Rider. Frame-only warranty option for customers without a Therma-Tru door system.

Available Textures





 Ready to finish.

Buff Grained

- Features a universal wood grain to complement a wide range of grain species.
- Stain or paint to complement the entry – no sanding or priming required.















 Ready to install.
 Ready to finish.

White Smooth

- Features a matte finish similar to painted wood and includes a protective layer with UV inhibitors to help resist yellowing and fading.
- Ready to install as-is – no painting required. Or finish with stain or paint to complement the entry – no sanding or priming required.

The advantage is clear.

Performance		
Resists Moisture & Humidity – Eliminates Risk of Swelling, Warping and Splitting		
Resists Mold, Fungus & Rot – Does Not Absorb or Retain Moisture		
Resists Insects – Help Protect from Wood-Ingesting Insects		
Tested to be up to 50% stronger on average than standard wood door frames against kick-ins.**		
Impact and 20-Minute Fire Code Compliant***		
Aesthetics		
Ready to Finish – No Sanding or Priming Required		
Ready-to-Install Option – No Finishing Required – White Smooth		
Universal Grain Complements a Wide Range of Wood Species – Buff Grained		
Screw Plugs Match Frame Material and Conceal External Fasteners		
Warranty		
Therma-Tru Products & Applications	Warranty For First Homeowner	Warranty Riders Transferable 1x to Second Homeowner
Composite Door Frame + Classic Craft® Door + Components		Lifetime Transferable Full-System Rider
Composite Door Frame + Fiber-Classic®, Smooth-Star®, Pulse® Fiberglass Door + Components		10-Year Transferable Full-System Rider
Composite Door Frame Only		

Composite Door Frame Parts

See your Therma-Tru seller for a full list of available product sizes and options.

Jambs



- 4-1/8"
- 4-9/16"
- 5-1/4"
- 6-9/16"
- 7-1/4"

Mullions



- 2" Entry Narrow
- 2-1/2" Entry Wide

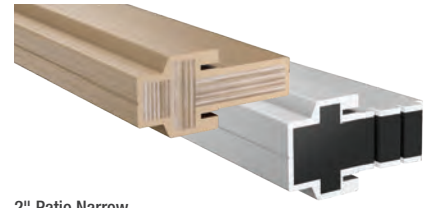

- 2" Patio Narrow
- 2-1/2" Patio Wide

Pre-inserted weatherstrip option available for select white smooth jambs and mullions.

Trim



2" Brickmould WM180



1-5/8" Florida Brickmould WM176

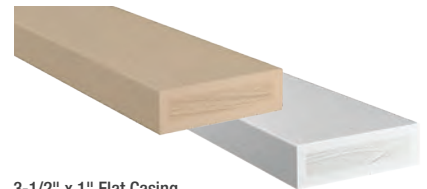

3-1/2" x 1" Flat Casing

Mull Casing



1-15/32" x 1-1/16"



1-7/32" x 7/32"
NEW SIZE 2" x 7/32"



2-15/16" x 1-1/16" *Buff grained only.*
2-15/16" x 3/8" *Buff grained only.*

Storm Door-Ready Mullion Adaptor

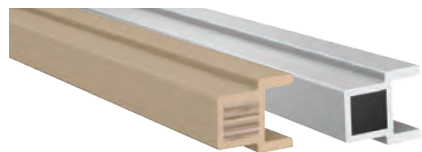

2" to 1-11/16"

Storm Door Adaptor



4-9/16" Base Adaptor
Face Adaptor
(Use 1-15/32" x 1-1/16" Mull Casing)



6-9/16" Base Adaptor

Screen Track Cap



1-13/32" x 9/16"

Fasteners, Setting Tool & Screw Plug Covers



Screw plugs are available on a collated strip for ease of installation and finishing.

Storm Door-Ready Mullions

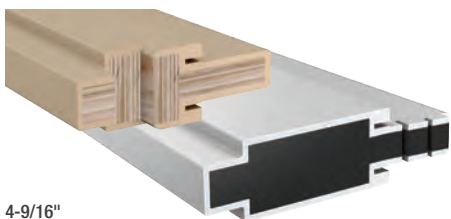

4-9/16"
6-9/16"

Engineered as part of Therma-Tru's complete entry door system, our composite door frame is

more reliable and up to 50% stronger on average than standard wood door frames*

when withstanding a simulated forced entry attempt by kicking in the door.*



7/16" x 5/16" Cove Mould

Transom Sills



4-9/16"
6-9/16"

Pendulum Impact Test



Therma-Tru Wood Jamb



Therma-Tru Composite Jamb

Code-Compliant Options

Therma-Tru composite door frame delivers the durability and reliability you expect from Therma-Tru with options to meet select national and local building code requirements.**



Impact-rated to meet high-wind and coastal region codes and regulations, offering excellent performance in extreme weather conditions while providing added protection.**



20-minute Fire-rated to meet most national and local code requirements for house-to-garage, multi-family residential and hotel / motel unit entries.**

*Comparison of pendulum impact test results for Therma-Tru composite door frame and standard finger-jointed Pine wood door frame, both with similar pre-hung doors.

**To confirm code requirements in your jurisdiction, always check with your local building code authority.

Note: See your Therma-Tru seller or visit www.thermatru.com for product approvals and installation instructions. Always confirm building code requirements in your area before buying. Follow weather and news reports to assess severe weather situations and obey local authorities' shelter and evacuation orders. No product guarantees safety for persons or property, nor makes any premises hurricane- or impact-proof. To see full results of third-party Intertek, Warnock-Hersey testing, visit www.thermatru.com/performance.

Sills

Allow for a tight seal to help block wind-driven moisture infiltration at the bottom of the door and a solid stepping surface. Available in a variety of materials with features to meet the needs of different climates and exposures. Ask your Therma-Tru seller for a complete list of options.

Inswing Options



Composite Adjustable Sill (Premium) 

- Thick wood-grained composite cap and nosing.
- U-shaped weather seal.
- Adjustable flush screws.

Continuous length with spread mullion capability to fill 49"–75" rough openings.*



Hardwood Adjustable Sill

- Durable hardwood cap and nosing can be stained to match door and trim.
- U-shaped weather seal.
- Adjustable flush screws.



Basic Composite Adjustable Sill (Economy)

- Wood-grained composite cap and nosing.
- Adjustable screws with removable screw caps.



Basic Fixed Sill (Economy)

- Slanted cap and nosing mates with the single-bulb bottom sweep.

Outswing Options



Composite Outswing Sill (Premium) 

- Thick wood-grained composite cap and nosing.
- Integrated weatherstrip.
- Helps meet code requirements in HVHZ coastal regions.



Aluminum Sill with Thermal Break

- All-aluminum construction.
- Integrated weatherstrip.
- Also available without thermal break.



Coastal Sill (For Coastal Regions)

- All-aluminum construction.
- Extra-high cap profile.
- Integrated weatherstrip.
- Helps meet code requirements in HVHZ coastal regions.

Outswing Sill Extender



Finishes: Lightwood (Premium), Darkwood (Premium)
 Sizes: 3/4", 2"

Shown in 2".

Inswing Sill Extenders

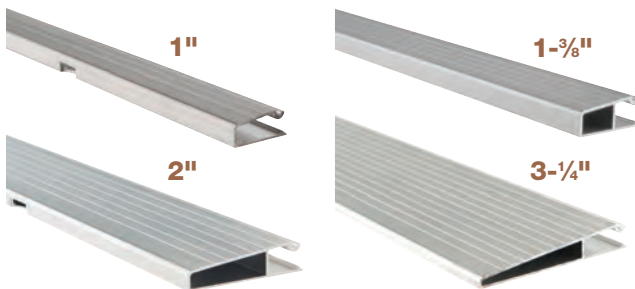

1", 1-3/8", 2", 3-1/4"

Public Access Sill



Public Access Sill with Thermal Break**
 (For ADA Applications)

- All-aluminum construction.
- Ramp slope meets Americans with Disabilities Act (ADA) requirements.
- Also available without thermal break.

Key

 Tru-Defense Eligible

*See the Therma-Tru Architectural Details & Components manual for actual unit size specifications.

**Door systems built with public access sills have little resistance to water penetration and have a potential to leak if installed exposed to weather. We recommend these systems be installed away from weather under large soffits or overhangs.

***For full details on the Tru-Defense Warranty Rider, visit www.thermatru.com/trudefense.

Note: Finish colors may vary from an actual application due to fluctuations in finishing or printing. See page 299 for important product details that may help with your purchase decision.

Sill Finishes



Mill



Bronze

Cap Colors



Lightwood (Premium)

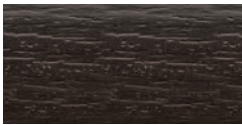

Darkwood (Premium)



Lightwood (Economy)



Darkwood (Economy)



Hardwood

■ = Available
• = Not Applicable

	Inswing Options				Outswing Options				Public Access (Inswing / Outswing)	
	Composite Adjustable	Hardwood Adjustable	Basic Composite Adjustable	Basic Fixed	Composite Outswing	Aluminum with Thermal Break	Aluminum without Thermal Break	Coastal	Public Access (Inswing / Outswing)	Public Access (ADA)**
Sill Finishes										
Mill	■	■	■	■		■	■	■	■	■
Bronze	■	■	■	■		■	■	■	•	■
Cap Colors										
Lightwood	■	•	■	•		■	•	•	•	•
Darkwood	■	•	■	■		■	•	•	•	•
Hardwood	•	■	•	•		•	•	•	•	•
Sill Configurations										
Single	■	■	■	■		■	■	■	■	■
French	■	■	•	■		■	■	■	■	■
Double Patio	■	■	•	•		■	•	•	•	•
Triple Patio	■		•	•		■	•	•	•	•
Lineal	■	■	•	•		•	•	•	•	•
Sidelite Configurations										
Boxed Sidelites	■	•	•	•		•	•	•	•	•
Single with Sidelites	■	■	•	•		■	•	•	•	•
French with Sidelites	■	•	•	•		•	•	•	•	•
Single Vented Sidelites	■	•	•	•		•	•	•	•	•
French Vented Sidelites	■	•	•	•		•	•	•	•	•
Depths										
4-9/16"	■	•	■	■		■		■	■	■
5-3/4"	■	■	■	■		■	■	•	•	•
6-9/16"	•	•	•	•		•	•	•	•	■
7-3/4"	■	■	■	■		•	■	•	•	•
Substrates										
Composite Extruded	■	•	•	•		■	•	•	•	•
Composite Injection Molded	■	•	■	•		•	•	•	•	•
Treated Pine	•	■	•	■		•	■	■	■	•
Other Options										
Integrated Thermal Break	■	■	■	■		■	■	•	•	■
Screen Rail Available	■	■	•	•		■	•	•	•	•
Sill Extenders Available	■	■	■	•		■	•	•	•	•
Sill Covers Available	■	■	■	■		■	•	•	•	•
Tru-Defense Eligible***	■	•	•	•		■	•	•	•	•
With Anchor Holes	•	•	•	•		•	■	■	•	■
Without Anchor Holes	■	■	■	■		■	■	•	■	•

Note: See your Thermo-Tru seller for details on available component and finish color combinations.

Door Bottoms

Designed to mate with our sills and help provide added protection to help seal the margin between the door and sill. Kerf-applied for a secure fit and made of a heavy-duty material that holds its shape to help maintain contact.

Inswing Options



Kerf-Applied Dual-Bulb / Dual-Fin Bottom Sweep

Sills:
Composite Adjustable
Hardwood Adjustable
Basic Composite Adjustable

Colors:
Bronze
White



Non-kerf-applied option available for replacement applications. Available in bronze only.

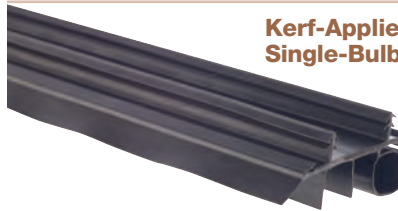

Kerf-Applied Single-Bulb Bottom Sweep

Sills:
Basic Fixed

Colors:
Bronze



Inactive Door Bottom

Sills:
Composite Adjustable
Hardwood Adjustable

Colors:
Bronze

Outswing Options

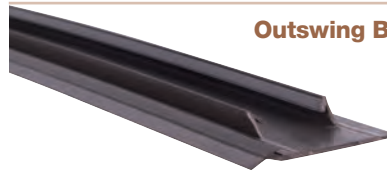

Outswing Bottom Sweep

Sills:
Aluminum
Coastal

Color:
Bronze



Inactive Door Bottom

Sills:
Composite Outswing

Colors:
Bronze

ADA / Replacement



Bottom Sweep

Sills:
Public Access

Color:
Bronze

Sill Protection



Sill Covers (Recommended)

- Fits over the sill to help protect cap and finish from damage during installation.
- Made of a heavy-duty material to withstand wear.
- Available in a variety of options to fit our sills.

See page 285 for availability.

Shown over composite adjustable sill.



Sill Pan (Recommended)

- Fits between the sill and subfloor for an added layer of protection against moisture.
- Engineered with sloped channels to help collect and drain moisture away.

Corner Seal Pads (Inswing Only)

Fit securely behind weatherstrip and mate with our inswing sills to help block wind-driven moisture from pushing through the corner and up the frame. (Not required for outswing sills.)

Classic Craft. 7-Shape Pads



Colors:
Bronze
White

Sills:
Composite Adjustable
Hardwood Adjustable
Basic Composite Adjustable
Public Access

Fiber-Classic. / Smooth-Star. 7-Shape Pads



Colors:
Bronze
White

Sills:
Composite Adjustable
Hardwood Adjustable
Basic Composite Adjustable
Public Access

Basic Fixed Pads



Colors:
Bronze

Sills:
Basic Fixed

Weatherstrip

Engineered in a variety of profiles for a precise seal between the door and frame. Made of a flexible material protected by a durable jacket to resist moisture and wear.

Medium-Reach Weatherstrip



Colors:
Bronze
White

Long-Reach Weatherstrip



Colors:
Bronze
White

Rain Protection (Recommended)

Helps repel moisture away from areas exposed to wind-driven moisture infiltration, enhancing weather protection. Highly recommended for applications directly exposed to wind and rain.

Rain Deflector (Inswing)



Colors:
Bronze
White

Rain Guard (Outswing)



Colors:
Bronze
White

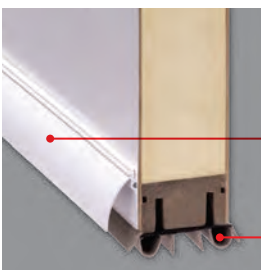

Rain Deflector

Bottom Sweep

Bottom of door;
exterior view.



Jamb

Rain Guard

Weatherstrip

Top of door;
exterior view.

Key

Tru-Defense Eligible

Hardware

Multi-Point Locking Systems (MPLS) (Recommended)

Engages the door and frame at three critical points from top to bottom for enhanced stability compared to traditional deadbolt assemblies. Features premium stainless steel construction that resists corrosion.



Grip-Style MPLS

Grip-style handlesets offer an intuitive approach to the multi-point locking system with on-trend aesthetics. A simple 90-degree twist of the thumbturn (interior) or a key (exterior) is all it takes to engage the door frame at three points with no need to lift the handleset lever. An integrated mishandling device protects the door and frame from accidental damage. Features deadbolt located above handleset.

(Highly recommended for 8'0" fiberglass doors. Active option only. Not available for door systems with an astragal. Not recommended for steel doors or Impressions integrated storm and entry door systems. Strike plate package available.)



Tongue
 Heights: | Configurations:
 6'8" | Inswing
 7'0" | Outswing
 8'0"

-  Self-lubricating locks.
-  1" premium stainless steel deadbolt.
-  Integrated mishandling device.

Key

 Tru-Defense Eligible

Side view of door.



Engages at three critical points.

Exterior view of door.



Side view of door.

Engages at three critical points.

Exterior view of door.

Lever-Style MPLS

Lever-style handlesets bring form and function together with decorative styles. A convenient upward turn of the handle is required before all three points will engage. An integrated mishandling device helps protect the door and frame from accidental damage. Features deadbolt below the handleset.

(Highly recommended for 8'0" and double fiberglass doors. Not recommended for steel doors. Strike plate packages available to meet the installation needs of various MPLS applications.)



Tongue
 Heights: 6'6", 6'8", 7'0", 8'0"
 Configurations: Inswing, Outswing



Shootbolt
 (For door systems with an astragal.)
 Heights: 6'6", 6'8", 7'0", 8'0"
 Configurations: Inswing, Outswing



Vented Sidelite MPLS



Tongue
 (Included in vented sidelite units.)
 Heights: 6'6", 6'8", 8'0"

Handleset Options for Standard Door MPLS

Designed to complement Therma-Tru® door styles from traditional to contemporary.

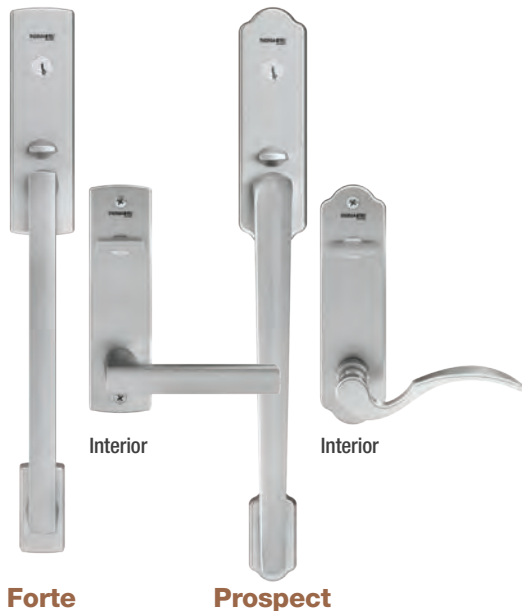

Forte

Prospect

Finish Options

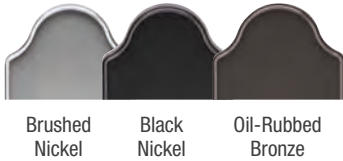

Brushed Nickel

Black Nickel

Oil-Rubbed Bronze

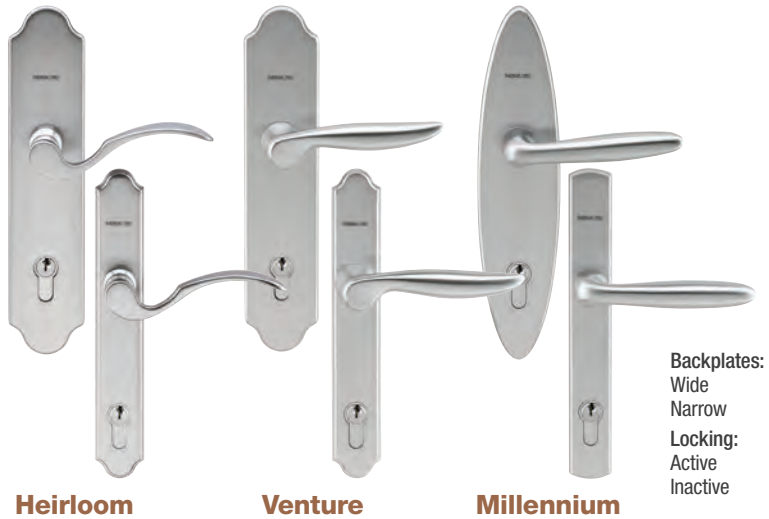

Heirloom

Venture

Millennium

Backplates:
Wide
Narrow
Locking:
Active
Inactive

Finish Options

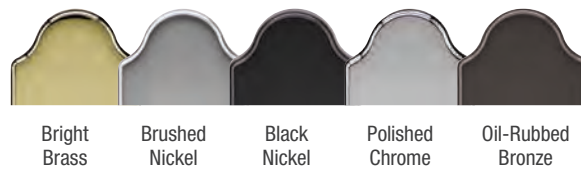

Bright Brass

Brushed Nickel

Black Nickel

Polished Chrome

Oil-Rubbed Bronze

Latch & Deadbolt Strike Plate



Standard vs. Adjustable Security Strike Plate

Adjustable Security Strike Plate

(Recommended for standard lock and deadbolt handlesets only.)

Finish Options:

- Brushed Nickel
- Black Nickel
- Polished Chrome
- Oil Rubbed Bronze
- Stainless Steel
- Zinc Dichomate

A genuine Therma-Tru adjustable security strike plate helps enhance the safety and security of a home, wrapping around the door jamb and fully engaging the frame of the house for added support and strength against forced entry.

- ❶ Wraps around the door jamb for added support and an exact fit.
- ❷ 2-1/2" screws fully engage with the frame of the house for added strength.

*To confirm code requirements in your jurisdiction, always check with your local building authority.
Note: See your Therma-Tru seller for available component options.

Hinges

Adjustable Hinge

(Recommended for Classic-Craft premium entryways.)

Allow the door to be moved horizontally and vertically in the frame, maintaining alignment and keeping the door performing beautifully.

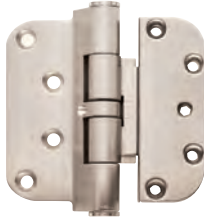

Self-Aligning Ball-Bearing

(Recommended for heavier Fiber-Classic, Smooth-Star and Steel doors.)

Contains locating tabs to assist in accurate alignment with specific door systems.



Classic-Craft® Ball-Bearing

(Recommended for Classic-Craft premium entryways.)

Ball bearings help protect each hinge pivot for added support and stability.

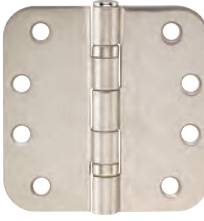

Self-Aligning

(Recommended for heavier Fiber-Classic, Smooth-Star and Steel doors.)

Contains locating tabs to provide accurate alignment with specific door systems. Note: Non-removable pin option available with fixed pins, providing security on outswing applications.



Classic-Craft® Ball-Bearing – Staggered Hole Pattern

(Recommended for Classic-Craft premium entryways.)

Ball bearings help protect each hinge pivot for added support and stability. Staggered hole pattern helps simplify assembly process. Note: Non-removable pin option available with fixed pins, providing security on outswing applications.



Security Tab

Security tabs prevent door from being taken off hinges, providing security on outswing applications.



Spring-Loaded

UL Listed with self-closing spring mechanism that helps pull the door closed for convenience or meets code requirements that may be applicable in Fire-door applications.*



Hinge Finish Options



Bright Brass Brushed Nickel Black Nickel Polished Chrome Oil-Rubbed Bronze Stainless Steel Zinc Dichromate

Hinge Finish Options	■ = Available • = Not Applicable		Adjustable	Classic Craft® Ball-Bearing	Classic Craft® Ball-Bearing – Staggered Hole Pattern	Classic Craft® Ball-Bearing – Staggered Hole Pattern (Non-Removable Pin)	Self-Aligning Ball-Bearing	Self-Aligning	Self-Aligning NRP (Non-Removable Pin)	Security Tab	Spring-Loaded
	Bright Brass	■	■	■	■	■	■	•	•	•	•
Brushed Nickel	■	■	■	■	■	■	■	■	■	■	■
Black Nickel	■	■	■	■	■	■	■	•	■	•	■
Polished Chrome	■	■	■	■	■	■	■	•	■	•	■
Oil-Rubbed Bronze	■	■	■	■	■	■	■	■	■	•	■
Stainless Steel	•	■	■	■	■	■	■	•	■	■	■
Zinc Dichromate	•	■	■	■	■	■	■	■	■	■	■

Hinges position the door to properly compress the weatherstrip and help ensure smooth operation. Features options to suit various applications and mate with mortise pockets machined into our doors. Adjustable security strike plate wraps around the jamb and engages the frame for added support and strength, and resistance against forced entry.

Astragals

Cover the margin between double doors to help complete the seal against air and moisture infiltration, with aluminum construction for stability, holding power and durability. Available in a stainable wood-grained vinyl wrap or aluminum.



Stainable Astragal

- Heights:**
6'6"
6'8"
7'0"
8'0"
- Width:**
7/8"
- Configurations:**
Inswing
Outswing
Multi-Point Lock
Double Bore
Left-Handed
Right-Handed
- Grain Options:**
Oak
Fir
- Weatherstrip:**
Bronze

Shown in Oak grain with Redwood stain.



Aluminum Astragal

- Heights:**
6'6"
6'8"
7'0"
8'0"
- Width:**
7/8"
- Configurations:**
Inswing
Outswing
Multi-Point Lock
Double Bore
Left-Handed
Right-Handed
- Finish Colors:**
Bronze
White
- Weatherstrip:**
Bronze

Coastal option also available.

Available with strike plates to receive a latch and deadbolt or multi-point locking system.

Integrated weatherstrip and corner seal pad helps form a tight seal between the astragal and active door when closed.

Spring clips to engage and disengage the shootbolts.

Durable boot engineered to work with the active bottom sweep to complete the seal across the sill.

16-1/2" locking steel slide bolt can be vertically adjusted for a secure fit with the sill and frame.

Textures Available

Stainable (Shown in Rustic Clay stain.)



Oak Grain

Fir Grain

Aluminum



Bronze

White



Note: Finish colors may vary from an actual application due to fluctuations in finishing or printing. See page 299 for important product details that may help with your purchase decision.

Bottom: Classic Craft Mahogany Grain, Provincial Glass, Doors – CCR804028

Right Page, Top: Classic Craft Walnut Grain Doors – CCW902R, CCW902L, Finish – Pinecone

Right Page, Bottom Left: Classic Craft Fir Grain, Homeward Glass, Doors – CCA211, Finish – Driftwood

Right Page, Bottom Right: Fiber-Classic Oak Collection, Clear Glass with GBGs, Doors – FC8313, Finish – Barley

Key

 Tru-Defense Eligible



Special Quote Program

In addition to thousands of standard glass choices, we offer additional glass options through our Special Quote Program to help you find the right look for virtually any home.



Special Quote SDL Pattern Example

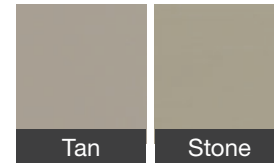
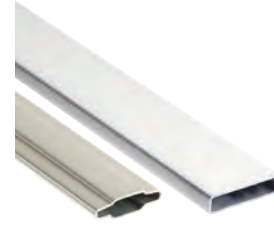

Special Quote
GBG Color Options

Divided Lites

Match various window patterns and home styles with additional grid patterns and color options. Impact-rated options also available.



Privacy & Textured Glass

Achieve the desired look and level of privacy with additional options, including hammered glass doorlites shown above.

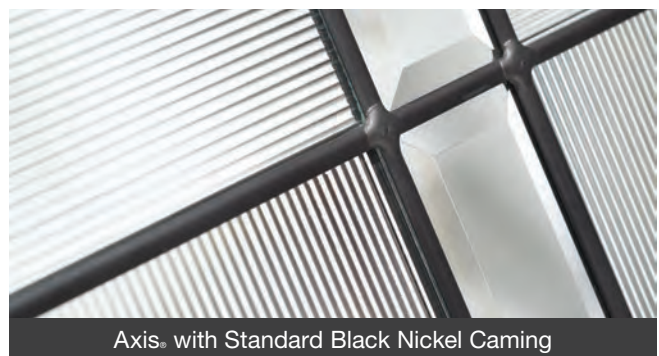

Axis® with Standard Black Nickel Caming



Axis® with Special Quote Brushed Nickel Caming

Caming Colors

Pair black nickel, brushed nickel or brass caming with any decorative glass design to complement home hardware and fixtures.

3'6" Width Door Style Options

Classic Craft®

8'0" Door Styles



Glass Designs

Homeward™	■		■			■	■
Augustine®	◆	◆	◆	◆	◆	◆	
Arborwatch®	■		■			■	■
Borrassa®	◆	◆	◆	◆	◆	◆	
Lucerna®	◆		◆			◆	
Rainglass							■
Low-E	◆		■			◆	■

Key

- Classic Craft® Artissa Collection™
- ◆ Classic Craft® Founders Collection™
- ▲ Classic Craft® Visionary Collection™
- * Smooth-Star®
- ▷ Profiles™ & Traditions

6'8" & 8'0" Solid-Panel Door Styles

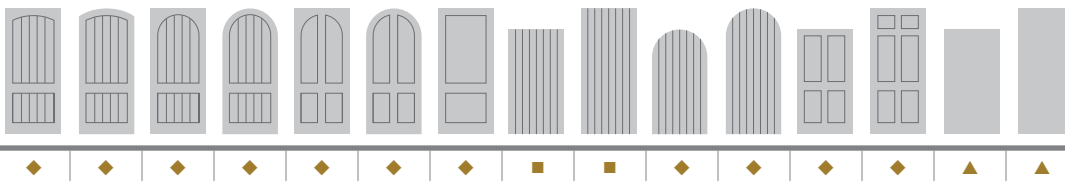

Smooth-Star®, Profiles™, Traditions & Pulse®

6'8" & 8'0" Door Styles



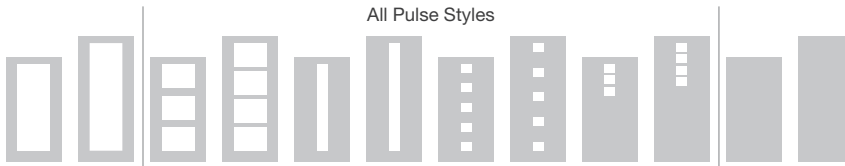







All Pulse Styles







Glass Designs

Blackstone®	*▷	*			*▷	*							
Crystalline™	*▷	*			*▷	*							
Sedona	*▷		*▷	*	*▷	*							
Salinas®	*▷	*			*▷	*							
Maple Park®	*▷												
Avonlea®	*▷				*▷								
Saratoga™	*▷		*▷	*	*▷	*							
Texas Star	*▷												
Wellesley™	*▷	*											
Riserva®	*▷	*	*▷	*	*▷	*							
Concorde™	*▷	*											
Kensington™	*▷												
Pembridge™	*▷	*	*▷	*	*▷	*	*▷	*	*▷	*			
Axis®	*▷	*	*▷	*	*▷	*	*▷	*	*▷	*			
Privacy & Textured Glass	*▷	*	*▷	*	*▷	*	*▷	*	*▷	*			
Internal Blinds	*▷	*											
Divided Lites	*▷	*											
Clear	*▷	*	*▷	*	*▷	*	*▷	*	*▷	*			
Solid Panel												*▷	*

7'0" Height Door Style Options

Glass Designs	Door Styles										
											
Blackstone [®]	▼▲*▷	▲*▷	*		▷						
Crystalline [™]	▼▲*▷	▲*▷	*		▷				▷		
Sedona	▼▲*▷	▲*▷	*		▷						
Salinas [™]	▼▲*▷	▲*▷	*		▷						
Maple Park [™]	▼▲*▷	▲*▷	*		▷			▲*▷			
Avonlea [™]	▼▲*▷	▲*▷	*		▷						
Saratoga [™]	▼▲*▷	▲*▷	*		▷		*	▲*▷			
Texas Star	▼▲*▷	▲*▷	*		▷						
Wellesley [™]	▼▲*▷	▲*▷	*		▷			▲*▷			
Riserva [™]	▼▲*▷	▲*▷	*		▷						
Concorde [™]	▼▲*▷	▲*▷	*		▷			▲*▷	▷		
Kensington [™]	▼▲*▷	▲*▷	*		▷						
Pembridge [™]	▼▲*▷	▲*▷	*		▷			▷		▲▷	
Axis [™]	▼▲*▷	▲*▷	*		▷					▲*▷	
Frosted Images [™]		▲*▷	*		▷						
Privacy & Textured Glass	▼▲*▷	▲*▷	*	▼▲*▷	▷		*			▲*▷	
Internal Blinds	▼▲*▷	▲*▷	*	▼▲*▷							
Screen Vented		*▷	*	*▷							
Divided Lites	▼▲*▷	▲*▷	*		▷	*▷	*	▲*▷	▷		▷
Clear	▼▲*▷	▲*▷	*	▼▲*▷	▷	*▷	*	▲*▷	▷	▲*▷	
Solid Panel											

6'6" Height Door Style Options

Glass Designs	Door Styles				
					
Blackstone [®]	▲*▷			▲*	
Crystalline [™]	▲*▷			▲*	
Sedona	▲*▷			▲*	
Salinas [™]	▲*▷			▲*	
Maple Park [™]	▲*▷			▲*	
Avonlea [™]	▲*▷			▲*	
Saratoga [™]	▲*▷			▲*	
Texas Star	▲*▷			▲*	
Wellesley [™]	▲*▷			▲*	
Riserva [™]	▲*▷			▲*	
Concorde [™]	▲*▷			▲*	
Kensington [™]	▲*▷			▲*	
Pembridge [™]	▲*▷			▲*	
Axis [™]	▲*▷			▲*	
Frosted Images [™]				▲*	
Privacy & Textured Glass	▲*▷	▷		▲*	
Internal Blinds	▲*▷	▷		▲*	
Screen Vented		▷			
Divided Lites	▲*▷		▷	▲*	
Clear	▲*▷	▷	▷	▲*	
Solid Panel					*▷

Key

- ▲ Classic Craft[®] Visionary Collection[™]
- ▼ Fiber-Classic[®] Mahogany Collection[™]
- ▲ Fiber-Classic[®] Oak Collection[™]
- * Smooth-Star[®]
- ▷ Profiles[™] & Traditions

		▽▲*D	D				
		▽▲*D	D				
		▽▲*D	D				
		▽▲*D	D				
		▽▲*D	D				
		▽▲*D	D				
		▽▲*D	D				
		▽▲*D	D				
		▽▲*D	D				
		▽▲*D	D				
		▽▲*D	D				
		▽▲*D	D				
		▽▲*D	D				
		▽▲*D	D	D			
		▽▲*D	D	D			
		▽▲*D	D	D			
		▽▲*D	D	D			
		▽▲*D	D	D			
		▽▲*D	D				
D		▽▲*D	D				
		▽▲*D	D	D			
					*	▲*D	▲▼▲*D



Top: Smooth-Star, Maple Park Glass, Door – S6107
 Bottom: Smooth-Star Door – S210; Clear Glass with GBGs, Sidelites – S308SL

Entry & Patio Door Systems

Feature	Classic Craft.	Fiber-Classic® & Pulse. Wood-Grained	Smooth-Star® & Pulse. Smooth	Profiles™ & Pulse. Steel (6'8")	Traditions & Pulse. Steel (8'0")
Skin Material	Fiberglass	Fiberglass	Fiberglass	24-Gauge Steel	6'8": 25-Gauge Steel / 8'0": 24-Gauge Steel
Skin Texture	Fir, Walnut, Mahogany, Oak Grain; High-Detail Smooth	Mahogany, Oak Grain	High-Detail Smooth	Smooth	Smooth
Exterior Finish	Stain or Paint	Stain or Paint	Paint	Paint	Paint
Interior Finish	Stain or Paint	Stain or Paint	Paint	Paint	Paint
Panel – Top Rail	Composite	Composite	Composite	Wood	Wood
Panel – Bottom Rail	Composite	Composite	Composite	Composite	Composite
Lock Stile	4" Full-Length Engineered Lumber	6'8": 1-1/4" Engineered Lumber 8'0": 3-15/16" Full-Length Engineered Lumber	6'8": 1-1/4" Engineered Lumber 8'0": 3-15/16" Full-Length Engineered Lumber	1-1/4" Wood	1-1/4" Wood
Lock Block	4" Full-Length Engineered Lumber Stile	22-1/2" Wood	12-1/2" Wood	12-1/2" Wood	6'8": 12-1/2" Wood / 8'0": 22-1/2" Wood
Height Options	6'8", 7'0" & 8'0"	6'6", 6'8", 7'0" & 8'0"	6'6", 6'8", 7'0" & 8'0"	6'6", 6'8" & 7'0"	6'8" & 8'0"
Width Options	2'6", 2'8", 2'10", 3'0" & 3'6"	2'0", 2'4", 2'6", 2'8", 2'10" & 3'0"	2'0", 2'4", 2'6", 2'8", 2'10", 3'0" & 3'6"	2'0", 2'4", 2'6", 2'8", 2'10", 3'0" & 3'6"	2'0", 2'4", 2'6", 2'8", 2'10" & 3'0"
Panel Options	Single, Double or Triple	Single, Double or Triple	Single, Double or Triple	Single, Double or Triple	Single, Double or Triple
Sidelite Options	12" & 14"	10", 12" & 14"	10", 12" & 14"	10", 12" & 14"	10", 12" & 14"
Glass Options	SMC Frame; Deco / Privacy & Textured / Low-E IG	Standard Frame, Advanta Frame, PVC Frame; Deco / Privacy & Textured / Low-E / Clear IG	Standard Frame, PVC Frame; Deco / Privacy & Textured / Low-E / Clear IG	Standard Frame, PVC Frame; Deco / Privacy & Textured / Low-E / Clear IG	Standard Frame, PVC Frame; Deco / Privacy & Textured / Low-E / Clear IG
Sill*	Inswing: Composite Adjustable Outswing: Composite Outswing	Inswing: Basic Composite Adjustable Outswing: Composite Outswing	Inswing: Basic Composite Adjustable Outswing: Composite Outswing	Inswing: Basic Fixed Outswing: Aluminum	Inswing: Basic Fixed Outswing: Aluminum
Weatherstrip – Hinge	Medium-Reach	Medium-Reach	Medium-Reach	Medium-Reach	Medium-Reach
Weatherstrip – Lock	Medium-Reach	Long-Reach	Long-Reach	Long-Reach or Magnetic	Long-Reach or Magnetic
Weatherstrip – Head	Medium-Reach	Long-Reach	Long-Reach	Long-Reach or Magnetic	Long-Reach or Magnetic
Multi-Point Lock	Recommended	Recommended	Recommended	–	–
Security Strike Plate	Recommended	Recommended	Recommended	Recommended	Recommended
Hinges*	Classic Craft Ball-Bearing	Self-Aligning	Self-Aligning	Self-Aligning	Self-Aligning
Frame*	Composite Door Frame	Composite Door Frame	Composite Door Frame	Rot-Resistant	Primed Pine
Screens & Screen Accessories Available Colors: Bronze, White	2" Frame	2" Frame	2" Frame	2" Frame	2" Frame
Residential Limited Warranty	Transferable Lifetime	Lifetime	Lifetime	10 Years	Door: 5 Years / Glass: 10 Years / Pulse 8'0": 10 Years

For dimensional data, see your Therma-Tru seller or visit thermatru.com for a copy of the Therma-Tru Unit & Rough Opening Sizing Booklet.

Therma-Tru® Door Systems

Independent Laboratory Performance Testing

At the time of manufacture, Therma-Tru exterior door systems (properly assembled with all genuine Therma-Tru components) have been tested under one or more of the following performance specifications: structural load, uniform load deflection, vertical load resistance, air infiltration, water penetration resistance, forced entry resistance, operating forces, force to latch, deglazing resistance, operating cycle performance, impact resistance, sound transmission, thermal performance and solar heat gain performance. Therma-Tru exterior door systems conform to the applicable Performance Standards / Test Methods that may include ANSI/AAMA/NWDA 101/I.S.2, AAMA/WDMA 101/I.S.2/NAFS, AAMA/WDMA/CSA 101/I.S.2-A440, ASTM E330, ASTM E547, ASTM E283, ASTM E331, ANSI/BHMA A156.2, AAMA 1304, AAMA 920, AAMA 925, ASTM E2068, ASTM F842, ASTM E987, ASTM E1300, ASTM E90, ASTM E413, ASTM E1332, ASTM E1886, ASTM E1996, PA/TAS 201, PA/TAS 202, PA/TAS 203, HUD UM89, AAMA 1702.2, 24 CFR 3280, 24 CFR 3282, NFRC 100 and NFRC 200. Refer to www.thermatru.com for design pressure and other performance ratings.

Doors

Recommended Door Overhang – For best performance, all doors should be protected by an overhang. The recommended size is half the distance from the base of the door to the bottom of the overhang. So, as an example, a distance of 10' for this dimension would require an overhang of 5' minimum. For wetter climates, southern or western exposures, and for double doors, the overhang should be the same as the distance from the base of the door to the bottom of the overhang. In this same example, the dimension is 10' so the overhang should be 10'.

For best performance, double doors to be used in areas with severe weather exposure must be installed using entry alcoves or large soffit overhangs to protect entry unit from exposure. Multi-point locking systems are highly recommended for 8'0" and double door applications.

Doorlites

Doorlites are insulated, and exposed panes are tempered or laminated. Optional wood grilles available for clear doorlites and transoms.

Inserts – All glass (except flush-glazed styles) shall be bedded with glazing mastic and secured in doors with screws. Therma-Tru's SMC and BTS doorlite frames are available for most styles except where noted. SMC and BTS frames shall resist significant deformation by heat up to 200 degrees Fahrenheit, regardless of paint or stain color or placement behind a storm door.

PVC doorlite frames must be finished within 30 days of installation. Failure to do so will increase the chance for product damage of the type that is not covered by the warranty. PVC doorlite frames are not recommended for use behind storm doors or to be painted dark colors, if exposed to direct sunlight.

Decorative Glass & Wrought Iron – Each Therma-Tru decorative glass unit is handcrafted by skilled artisans replicating Old World techniques. Each piece is a unique work of art and many things that would appear to be imperfections (small bubbles, lines and waves within the glass) are normal and are part of the designs character.

Direct Set Sidelites – All Therma-Tru direct set sidelites shall utilize trim components secured and glazed in place in the door jamb.

Condensation occurs naturally in the home, caused by excessive humidity in the air. Often this harmless water vapor can be seen collecting on glass surfaces, such as doorlites. Energy-efficient glass units in Therma-Tru door systems are constructed to keep the glass as warm as possible, reducing

condensation build-up. However, there is no such thing as a condensation-free window or doorlite in high-humidity conditions.

A common attribute of true wrought iron doorlites is that a rattle sound may be heard when closing the door. This is solely a function of having real wrought iron which is heavy and has the ability to flex, moving back and forth within a narrow airspace surrounded by glass that has very little flex. This characteristic is not considered a defect or warranty issue.

NOTE: Glass privacy ratings are determined by the 1/2-lite glass size. As a result, the amount of privacy / glass transparency may be more or less than indicated by the privacy rating, based on the glass design and size of the glass that is inserted into the door, sidelite or transom.

Glass designs may differ from depiction due to the size and hand craftsmanship of glass. See your Therma-Tru seller or visit www.thermatru.com for more details.

Components

Adjustable Security Strike Plate – Proprietary adjustable type, permitting in-out adjustment of door in frame, up to 3/16".

Hinges – Minimum hinge size 4" x 4" x .098".

Ball-bearing hinges are recommended for 8'0" doors, doors using heavy lites (e.g., wrought iron), all 20-Minute Fire-rated fiberglass doors, Impact-rated doors and glass, and all Classic Craft doors.

Use of the multi-point locking system is highly recommended for 8'0" and double fiberglass doors. Not recommended for steel doors.

Please be aware that single door units built with public access sills have little resistance to water penetration, and double doors built with these sills have a potential to leak if installed exposed to weather. We recommend that units be installed away from weather under large soffits or overhangs.

Use of a sill pan is recommended.

Fiber-Classic and Smooth-Star dentil shelves are not recommended for placement behind storm doors or to be painted dark colors, if exposed to direct sunlight.

Therma-Tru door surrounds must be finished within 30 days of installation. Failure to do so will increase the chance for product damage of the type that is not covered by the warranty.

Impact-Rated Products

Impact-rated products must be installed as part of a Therma-Tru door system in compliance with a Therma-Tru product approval. Visit www.thermatru.com for product approvals and full details on WBDR- (Wind-Borne Debris Region) / HVHZ- (High Velocity Hurricane Zone) compliant products. Follow weather and news reports in order to assess severe weather situations and obey local authorities' shelter and evacuation orders. No product guarantees safety for persons or property, nor makes any premises hurricane- or impact-proof.

Fire-Rating Performance Standards

Fire and building codes vary throughout the country and acceptance of products and labels is left to the discretion of the local authorities.

MODIFICATION OF PRODUCTS DESCRIBED IN THIS BROCHURE WHICH CARRY FIRE RATINGS (DOORS AND FRAMES) MAY VOID THE FIRE RATINGS.

Test conducted by Intertek, Warnock-Hersey.

Limited Warranties

Please be aware of the applicable Therma-Tru Limited Warranty which contains important restrictions, disclaimers, exclusions and conditions, as well as the below listed Installation, Finishing & Maintenance documents, related to the Therma-Tru product purchased (e.g., Fiberglass, Steel, Patio Door Systems), all of which can be obtained from your Therma-Tru seller or found in their entirety at www.thermatru.com:

- Therma-Tru. Fiberglass and Steel Door Systems Residential Limited Warranty: Fiberglass – Classic Craft, Fiber-Classic, Smooth-Star, and Pulse. Door Systems; Steel – Pulse, Profiles, and Traditions Door Systems
- Therma-Tru. Tru-Defense. Door System Rider to Fiberglass Door Systems Limited Warranty: Classic Craft, Fiber-Classic, Smooth-Star and Pulse. Fiberglass Door Systems
- EnLiten. Flush-Glazed Construction & Installation Rider to Fiberglass Door Systems Limited Warranty for Residential and Multi-Resident Premises: Classic Craft, Fiber-Classic, and Smooth-Star. Flush-Glazed Fiberglass Door Systems
- EnLiten. Flush-Glazed Homeowner Rider to Fiberglass Door Systems Limited Warranty for Residential and Multi-Resident Premises: Classic Craft, Fiber-Classic, and Smooth-Star. Flush-Glazed Fiberglass Door Systems
- PrismaGuard. Limited Warranty Rider to Fiberglass and Steel Door Systems Limited Warranty for Residential and Multi-Resident Premises: Fiberglass – Classic Craft, Fiber-Classic, Smooth-Star, and Pulse. Door Systems; Steel – Pulse, Profiles and Traditions
- Same-Day. Stain 5-Year Limited Warranty: Same-Day. Stain and Topcoat for Use on Therma-Tru. Fiberglass Door Systems and Fypon. Stainable Polyurethane Products
- Therma-Tru. Composite Door Frame featuring Tru-Guard. Composite Technology Limited Warranty for Residential and Multi-Resident Premises: Classic Craft, Fiber-Classic, Smooth-Star, and Pulse. Fiberglass Door Systems
- Therma-Tru. Composite Door Frame featuring Tru-Guard. Composite Technology Limited Warranty Transferable Rider to Fiberglass Door Systems Limited Warranty for Residential and Multi-Resident Premises: Classic Craft, Fiber-Classic, Smooth-Star, and Pulse. Fiberglass Door Systems

Installation, Finishing & Maintenance

Therma-Tru doors and sidelites come unfinished. Installation, finishing and maintenance must be performed according to Therma-Tru's recommendations to comply with warranty requirements. Obtain a copy of the following documents outlining recommendations from your Therma-Tru seller or find them in their entirety at www.thermatru.com:

- Installation Instructions (Products that are approved for Coastal and / or high wind applications may require special installation. Always follow the installation instructions in the Product Approval for these products.)
- Therma-Tru Fiberglass and Steel Door Systems Recommendations for Proper Finishing and Painting or Staining

NOTE: Finish colors may vary from an actual application due to fluctuations in finishing or the printing of this catalog. See your Therma-Tru seller or visit www.thermatru.com for more details.

CCR804023.....	95	CCR820530XN.....	97	CCV106SL.....	77	CCV81515.....	94	CCV930XN.....	110
CCR804026.....	95	CCR820532.....	96	CCV106SL.....	88	CCV81516.....	94	CCV930XR.....	110
CCR804027.....	92	CCR820532A.....	97	CCV108SL.....	77	CCV81519.....	86	CCV931.....	108
CCR804028.....	94	CCR820537.....	93	CCV108SL.....	87	CCV81838.....	103	CCV940.....	112
CCR804029.....	92	CCR820537A.....	93	CCV109SL.....	76	CCV81839.....	103	CCV940XC.....	110
CCR804030.....	99	CCR8205A.....	118	CCV109SL.....	85	CCV81843.....	89	CCV940XJ.....	110
CCR804030XC.....	97	CCR8222.....	118	CCV1414.....	91	CCV81846.....	103	CCV940XN.....	110
CCR804030XN.....	97	CCR822214.....	91	CCV1415.....	91	CCV81851SL.....	89	CCV940XR.....	110
CCR804032.....	96	CCR822215.....	93	CCV1418.....	83	CCV8205.....	120	CCV950SL.....	78
CCR804037.....	93	CCR822218.....	90	CCV1423.....	72	CCV820520.....	91	CCV950SL.....	84
CCR8040R.....	118	CCR822220.....	99	CCV1423SL.....	72	CCV820520XC.....	91	CCV950SL.....	113
CCR8100.....	118	CCR822220XC.....	91	CCV1423SL.....	83	CCV820520XN.....	91	CCV950XCSL.....	83
CCR8100R.....	118	CCR822220XN.....	91	CCV1423SL.....	109	CCV820522.....	97	CCV950XCSL.....	111
CCR8102SL.....	87	CCR822222.....	96	CCV1424.....	104	CCV820523.....	95	CCV950XESL.....	83
CCR81414.....	90	CCR822223.....	95	CCV1512.....	94	CCV820526.....	96	CCV950XESL.....	111
CCR81415.....	90	CCR822226.....	96	CCV1515.....	94	CCV820527.....	93	CCV950XGSL.....	83
CCR81417.....	90	CCR822227.....	92	CCV1516.....	94	CCV820528.....	95	CCV950XGSL.....	111
CCR81423SL.....	82	CCR822228.....	95	CCV1519.....	86	CCV820529.....	92	CCV950XHSL.....	120
CCR81511.....	94	CCR822229.....	92	CCV1528.....	77	CCV820530.....	100	CCV950XJSL.....	83
CCR81511A.....	94	CCR822238.....	102	CCV1838.....	103	CCV820530XC.....	97	CCV950XJSL.....	111
CCR81512.....	94	CCR8225.....	119	CCV1839.....	103	CCV820530XN.....	97	CCV950XNSL.....	83
CCR81512A.....	94	CCR8225R.....	118	CCV1843.....	89	CCV820532.....	97	CCV950XNSL.....	111
CCR81514.....	94	CCR89918.....	90	CCV1851.....	79	CCV820537.....	93	CCV950XRSL.....	83
CCR81515.....	93	CCR89919.....	90	CCV1851SL.....	79	CCV8220.....	120	CCV950XRSL.....	111
CCR81516.....	93	CCR89921.....	90	CCV1851SL.....	89	CCV822020.....	100	CCV960.....	112
CCR81518.....	93	CCR89925SL.....	82	CCV200.....	120	CCV822020XC.....	97	CCV960XC.....	111
CCR81838.....	102	CCR9918.....	90	CCV205.....	120	CCV822020XN.....	97	CCV960XJ.....	111
CCR81839.....	102	CCR9919.....	90	CCV20520.....	91	CCV822022.....	97	CCV960XN.....	111
CCR81841.....	102	CCR9921.....	90	CCV20520XC.....	91	CCV822022.....	95	CCV960XR.....	111
CCR81845.....	102	CCR9925.....	72	CCV20520XN.....	91	CCV822026.....	96	CCV9918.....	90
CCR81845A.....	102	CCR9925SL.....	72	CCV20522.....	97	CCV822027.....	93	CCV9919.....	90
CCR81846.....	102	CCR9925SL.....	82	CCV20523.....	95	CCV822028.....	95	CCV9922.....	82
CCR81846A.....	102	CCV050.....	120	CCV20527.....	93	CCV822029.....	92	CCV9925.....	72
CCR81847.....	102	CCV05020.....	84	CCV20537.....	93	CCV831.....	120	CCV9926.....	104
CCR81851SL.....	89	CCV05020XC.....	83	CCV220.....	120	CCV8950SL.....	84	CCW1000.....	116
CCR8200.....	119	CCV05020XN.....	83	CCV22020.....	100	CCV8950SL.....	113	CCW81000.....	116
CCR820020.....	99	CCV05022.....	87	CCV22020XC.....	97	CCV8950XCSL.....	83	CCW8900L.....	116
CCR820020XC.....	97	CCV05023.....	86	CCV22020XN.....	97	CCV8950XCSL.....	111	CCW8900R.....	116
CCR820020XN.....	97	CCV05026.....	88	CCV22022.....	97	CCV8950XGSL.....	83	CCW8901L.....	116
CCR820022.....	96	CCV05027.....	85	CCV22023.....	95	CCV8950XGSL.....	111	CCW8901R.....	116
CCR820023.....	95	CCV05028.....	87	CCV22027.....	93	CCV8950XHSL.....	120	CCW8902L.....	116
CCR820026.....	96	CCV05029.....	85	CCV3412SL.....	78	CCV8950XJSL.....	83	CCW8902R.....	117
CCR820027.....	92	CCV060.....	120	CCV3412SL.....	87	CCV8950XJSL.....	111	CCW8903.....	117
CCR820028.....	95	CCV06020.....	106	CCV4100.....	109	CCV8950XNSL.....	83	CCW8904L.....	117
CCR820029.....	92	CCV06020XE.....	106	CCV4100SL.....	109	CCV8950XNSL.....	111	CCW8904R.....	117
CCR820030.....	100	CCV06022.....	106	CCV4300.....	109	CCV8950XRSL.....	83	CCW8905.....	117
CCR820030A.....	100	CCV06023.....	105	CCV805020.....	84	CCV8950XRSL.....	111	CCW8906L.....	117
CCR820030XC.....	97	CCV06026.....	105	CCV805022.....	87	CCV89918.....	90	CCW8906R.....	117
CCR820030XN.....	97	CCV06028.....	105	CCV805023.....	86	CCV89919.....	90	CCW8907L.....	117
CCR820032.....	96	CCV06029.....	105	CCV805026.....	88	CCV89922.....	82	CCW8907R.....	117
CCR820032A.....	97	CCV10020.....	78	CCV805027.....	85	CCV89925.....	82	CCW8907R.....	116
CCR820037.....	93	CCV10022.....	78	CCV805028.....	87	CCV9010SL.....	113	CCW900L.....	116
CCR820037A.....	93	CCV10023.....	77	CCV805029.....	85	CCV9011SL.....	108	CCW900R.....	116
CCR8200A.....	118	CCV10026.....	77	CCV8100SL.....	84	CCV9020SL.....	113	CCW901L.....	116
CCR82035SL.....	84	CCV10027.....	76	CCV8100SL.....	113	CCV910.....	112	CCW901R.....	116
CCR82035XCSL.....	83	CCV10028.....	77	CCV8100CSL.....	83	CCV910XC.....	110	CCW902L.....	116
CCR82035XESL.....	83	CCV10029.....	76	CCV8100XCSL.....	111	CCV910XCSL.....	111	CCW902R.....	117
CCR82035XGSL.....	83	CCV100SL.....	78	CCV8100XC.....	83	CCV910XJ.....	110	CCW903.....	117
CCR82035XHSL.....	119	CCV100SL.....	84	CCV8100XGSL.....	83	CCV910XJSL.....	111	CCW904L.....	117
CCR82035XJSL.....	83	CCV100SL.....	113	CCV8100XGSL.....	111	CCV910XN.....	110	CCW904R.....	117
CCR82035XKSL.....	83	CCV100XCSL.....	83	CCV8100XHSL.....	86	CCV910XNSL.....	111	CCW905.....	117
CCR82035XNSL.....	83	CCV100XCSL.....	111	CCV8100XJSL.....	83	CCV910XR.....	110	CCW906L.....	117
CCR82035XRSL.....	83	CCV100XESL.....	83	CCV8100XJSL.....	111	CCV910XRSL.....	111	CCW906R.....	117
CCR8205.....	119	CCV100XESL.....	111	CCV8100XNSL.....	83	CCV911.....	108	CCW907L.....	117
CCR820520.....	91	CCV100XGSL.....	83	CCV8100XNSL.....	85	CCV911SL.....	72	CCW907R.....	117
CCR820520XC.....	91	CCV100XGSL.....	111	CCV8100XNSL.....	111	CCV911SL.....	82	DRS2131SL.....	117
CCR820520XN.....	91	CCV100XHSL.....	77	CCV8100XRSL.....	83	CCV911SL.....	108	DRS2131SL.....	117
CCR820522.....	96	CCV100XHSL.....	86	CCV8100XRSL.....	111	CCV920.....	112	HW30T.....	122
CCR820523.....	95	CCV100XJSL.....	83	CCV8102SL.....	87	CCV920XC.....	110	HWRT.....	122
CCR820526.....	95	CCV100XJSL.....	111	CCV8103SL.....	87	CCV920XC.....	111	LC30T.....	122
CCR820527.....	92	CCV100XNSL.....	76	CCV8106SL.....	88	CCV920XJ.....	110	LCET.....	122
CCR820528.....	95	CCV100XNSL.....	83	CCV8108SL.....	87	CCV920XJSL.....	111	LCRT.....	122
CCR820529.....	92	CCV100XNSL.....	85	CCV8109SL.....	85	CCV920XN.....	110	LF30T.....	122
CCR820530.....	100	CCV100XNSL.....	111	CCV8111SL.....	82	CCV920XNSL.....	111	LFET.....	122
CCR820530A.....	100	CCV100XRSL.....	83	CCV81414.....	91	CCV920XR.....	110	LFRT.....	122
CCR820530AXC.....	97	CCV100XRSL.....	111	CCV81415.....	91	CCV920XRSL.....	111	ZHRT.....	122
CCR820530AXN.....	97	CCV103SL.....	77	CCV81418.....	83	CCV930.....	112		
CCR820530XC.....	97	CCV103SL.....	87	CCV81423SL.....	83	CCV930XC.....	110		
				CCV81512.....	94	CCV930XJ.....	110		

Steel

S985	202	100	246	1025HD	238	1201SL	235	237HD	246	584SLHD	240
S988	181	104	242	1027SL	233	1201SL	248	243HD	241	588HD	243
S989	183	105	242	1029SL	233	1202SL	235	255HD	246	601HD	245
S991	182	108	235	1031HD	239	1202SL	248	256HD	246	601XCHD	244
S992	183	118	235	1031SLHD	239	128XC	234	262HD	242	601XEHD	244
S994	183	128	235	1032HD	239	128XE	234	262HDXC	241	601XJHD	244
S995	182	130	235	1034HD	239	128XG	234	262HDXE	241	601XNHD	244
S997	181	131	241	1035HD	239	128XJ	234	262HDXG	241	601XRHD	244
S999	182	137	241	1037HD	236	128XK	234	262HDXJ	241	602HD	244
SART	221	139	233	1037SLHD	236	128XN	234	262HDXK	241	604HD	244
		198	235	1038HD	236	128XR	234	262HDXN	241	605HD	245
		310	233	1038SLHD	236	130SL	235	262HDXR	241	605HDXC	244
		369	233	1039HD	236	130SL	248	263HD	244	605HDXE	244
		571	234	1039SLHD	236	132HD	241	263HDXC	244	605HDXJ	244
		610	233	1040HD	236	132SLHD	241	263HDXE	244	605HDXX	244
		620	233	1040SLHD	236	138SL	234	263HDXG	244	605HDXR	244
		626	234	1041HD	236	139SL	233	263HDJ	244	606HD	245
		800	252	1041SLHD	236	1400SLHD	237	263HDK	244	606HDXC	244
		808	248	1042HD	236	1403HD	237	263HDXN	244	606HDXE	244
		810	252	1044HD	243	1405HD	242	263HDXR	244	606HDJ	244
		818	249	1047HD	238	1405SLHD	242	263SLHD	242	606HDXN	244
		828	248	104XC	241	1406HD	242	263SLHDXC	241	606HDXR	244
		829	248	104XE	241	1408HD	242	263SLHDXE	241	607HD	245
		896	252	104XG	241	1411HD	244	263SLHDXG	241	607HDXC	244
		916	233	104XJ	241	1643HD	246	263SLHDJ	241	607HDXE	244
		1006	233	104XK	241	1643SLHD	246	263SLHDK	241	607HDJ	244
		1027	233	104XN	241	1644HD	237	263SLHDN	241	607HDXN	244
		1028	234	104XR	241	1644SLHD	237	263SLHDXR	241	607HDXR	244
		1029	233	1055HD	245	1650HD	244	289EHD	243	608HD	245
		1200	235	1089SLHD	237	1651HD	234	289ESLHD	241	608HDXC	244
		1201	235	108XC	234	1651SL	234	289HD	244	608HDXE	244
		1202	235	108XE	234	1657HD	240	289HDXC	244	608HDJ	244
		1203	235	108XG	234	1657SLHD	240	289HDXE	244	608HDXN	244
		5425	237	108XJ	234	1659HD	240	289HDXG	244	608HDXR	244
		8132	249	108XK	234	1660HD	240	289HDJ	244	609HD	244
		8145	250	108XN	234	1662HD	243	289HDK	244	610SL	233
		8206	250	108XR	234	19020T	253	289HDN	244	613HD	239
		8317	252	1101HD	242	19055T	253	289HDXR	244	615HD	243
		8321	250	1101XCHD	241	19080T	253	294HD	243	615SLHD	239
		8322	250	1101XEHD	241	19200T	253	294SLHD	239	6184SL	235
		8323	250	1101XGHD	241	19210T	253	296HD	246	6184SL	248
		8324	250	1101XJHD	241	19220T	253	296HDXC	246	6184XCSL	234
		8704	251	1101XKHD	241	19520T	253	296HDXE	246	6184XC	247
		8708	251	1101XNHD	241	19720T	253	296HDXG	246	6184XCSL	234
		8752	251	1101XRHD	241	19730T	253	296HDJ	246	6184XESL	247
		03142HD	236	1102HD	241	19740T	253	296HDK	246	6184XJSL	234
		1001HD	238	1107HD	239	19750T	253	296HDN	246	6184XJSL	247
		1002HD	239	1110HD	241	19800T	253	296HDXR	246	6184XNSL	234
		1004HD	241	1111HD	239	19810T	253	296SLHD	246	6184XNSL	247
		1005HD	246	1112HD	239	19820T	253	296SLHDXC	246	6184XRSL	234
		1006SL	233	1113HD	240	198SL	235	296SLHDXE	246	6184XRSL	247
		1007HD	239	1114HD	239	198SL	249	296SLHDXG	246	6185SL	235
		1007SLHD	239	1115HD	239	203HD	246	296SLHDJ	246	6185SL	248
		1008HD	243	1116HD	239	205HD	246	296SLHDK	246	6185XCSL	234
		1009HD	236	1117HD	238	206EHD	241	296SLHDN	246	6185XCSL	247
		1009SLHD	236	1118HD	240	206HD	242	296SLHDXR	246	6185XESL	234
		100SL	235	1119HD	238	206HDXC	241	309HD	238	6185XESL	247
		100SL	249	1120HD	240	206HDXE	241	310SL	233	6185XJSL	234
		100XCSL	234	1121HD	241	206HDXG	241	311HD	243	6185XJSL	247
		100XCSL	248	1123HD	242	206HDJ	241	311SLHD	238	6185XNSL	234
		100XESL	234	1123HDXC	241	206HDXK	241	369SL	233	6185XNSL	247
		100XESL	248	1123HDXE	241	206HDN	241	371HD	243	6185XRSL	234
		100XGSL	234	1123HDXG	241	206HDXR	241	371SLHD	239	6185XRSL	247
		100XGSL	248	1123HDJ	241	2109HD	237	374HD	239	6186SL	235
		100XJSL	234	1123HDXK	241	210HD	246	416SL	234	6186SL	248
		100XJSL	248	1123HDN	241	210SLHD	242	426HD	240	6186XCSL	234
		100XKSL	234	1123HDXR	241	210SLHDXC	241	430HD	243	6186XCSL	247
		100XKSL	248	115HD	242	210SLHDXE	241	430SLHD	240	6186XESL	234
		100XNSL	234	118XC	234	210SLHDXG	241	454HD	245	6186XESL	247
		100XNSL	248	118XE	234	210SLHDJ	241	4572SLHD	237	6186XJSL	234
		100XRSL	234	118XG	234	210SLHDK	241	508HD	244	6186XJSL	247
		100XRSL	248	118XJ	234	210SLHDN	241	5425SL	237	6186XNSL	234
		1011HD	239	118XK	234	210SLHDXR	241	544HD	236	6186XNSL	247
		1020HD	238	118XN	234	2110HD	237	546SLHD	236	6186XRSL	234
		1021HD	238	118XR	234	2111HD	237	576HD	240	6186XRSL	247
		1022HD	238	1200SL	235	211HD	239	578HD	240	620SL	233
		1024HD	238	1200SL	248	236HD	246	582HD	240	623HD	240

625HD	243	8321XC	249	999HD	240	TS237	252	100	258	DRS2131SL	271
625SLHD	240	8321XE	249	AVRT	253	TS243	249	1005HD	258	DRS82131SL	271
626SL	234	8321XG	249	AXRT	253	TS255	251	203HD	258	S10AXSL	272
627HD	240	8321XJ	249	BSRT	253	TS256	251	205HD	258	S10CLSL	272
628HD	243	8321XK	249	CNRT	253	TS262	250	210HD	258	S10PBSL	271
628SLHD	240	8321XN	249	FWRT	253	TS262XC	249	969HD	258	S10XCSSL	272
630HD	238	8321XR	249	KNRT	253	TS262XE	249	978HD	258	S10XESL	272
631HD	240	86184SL	248	PBRT	253	TS262XG	249	FCF100	257	S10XGSL	272
632SL	235	86185SL	248	RSRT	253	TS262XJ	249	FCF160	257	S10XJSL	272
632SL	248	86186SL	248	SART	253	TS262XK	249	FCF31	256	S10XKSL	272
632XCSSL	234	896XC	252	TS100	252	TS262XN	249	FCF755	257	S10XNSL	272
632XCSSL	247	896XE	252	TS104	250	TS262XR	249	FCF809	256	S10XRSL	272
632XESL	234	896XG	252	TS104XC	249	TS263	251	FCF8100	257	S1651SL	271
632XESL	247	896XJ	252	TS104XE	249	TS263SL	250	FCF8160	257	S1AV	265
632XGSL	234	896XK	252	TS104XG	249	TS263XC	251	FCF862	257	S1AX	266
632XGSL	247	896XN	252	TS104XJ	249	TS263XCSL	249	FMF100	256	S1BL	264
632XJSL	234	896XR	252	TS104XK	249	TS263XE	251	FMF134	256	S1BS	264
632XJSL	247	916SL	233	TS104XN	249	TS263XESL	249	FMF205	256	S1CL	266
632XKSL	234	926HD	238	TS104XR	249	TS263XG	251	FMF220	256	S1LAV	265
632XKSL	247	930HD	243	TS105	250	TS263XGSL	249	FMF31	256	S1LAX	266
632XNSL	234	930SLHD	238	TS108	248	TS263XJ	251	FMF60	256	S1LBL	264
632XNSL	247	956SLHD	236	TS108XC	247	TS263XJSL	249	FMF600	256	S1LBS	264
632XRSL	234	959HD	237	TS108XE	247	TS263XK	251	FMF755	256	S1LCL	266
632XRSL	247	959HDXC	237	TS108XG	247	TS263XKSL	249	FMF8100	256	S1LPS	266
6500HD	234	959HDXCSL	237	TS108XJ	247	TS263XN	251	FMF860	256	S1LRS	265
6500SL	234	959HDXE	237	TS108XK	247	TS263XNSL	249	SSF100	258	S1LSA	265
6520HD	244	959HDXESL	237	TS108XN	247	TS263XR	251	SSF11	258	S1LSG	265
6560HD	240	959HDXG	237	TS108XR	247	TS263XRSL	249	SSF1100	257	S1LSN	265
6565HD	240	959HDXGSL	237	TS115	250	TS289	251	SSF120	257	S1LXC	266
6565SLHD	240	959HDXJ	237	TS118	249	TS289XC	251	SSF160	258	S1LXE	266
6568HD	240	959HDXJSL	237	TS118XC	247	TS289XE	251	SSF200	257	S1LXG	266
6570HD	246	959HDXK	237	TS118XE	247	TS289XG	251	SSF205	257	S1LXJ	266
6570SLHD	246	959HDXKSL	237	TS118XG	247	TS289XJ	251	SSF220	257	S1LXK	266
6572HD	243	959HDXN	237	TS118XJ	247	TS289XK	251	SSF31	257	S1LXN	266
6578HD	238	959HDXNSL	237	TS118XK	247	TS289XN	251	SSF4800	258	S1LXR	266
6580SLHD	237	959HDXR	237	TS118XN	247	TS289XR	251	SSF600	258	S1PB	266
6582HD	237	959HDXRSL	237	TS118XN	247	TS296	252	SSF755	257	S1RAV	265
6720HDXCSL	237	959SLHD	237	TS1200	248	TS296SL	252	SSF8100	258	S1RAX	266
6720HDXESL	237	961HD	237	TS1201	248	TS296XC	252	SSF81100	257	S1RBL	265
6720HDXGSL	237	961HDXC	237	TS1202	248	TS296XCSL	252	SSF8120	257	S1RBS	264
6720HDXJSL	237	961HDXE	237	TS1203	248	TS296XE	252	SSF8160	258	S1RCL	266
6720HDXKSL	237	961HDXG	237	TS128	248	TS296KESL	252	SSF8200	257	S1RPB	266
6720HDXNSL	237	961HDXJ	237	TS128XC	247	TS296XG	252	SSF8205	257	S1RRS	266
6720HDXRSL	237	961HDXK	237	TS128XE	247	TS296XGSL	252	SSF8220	257	S1RS	265
6720SLHD	237	961HDXN	237	TS128XG	247	TS296XJ	252	SSF831	257	S1RSA	265
704HD	245	961HDXR	237	TS128XJ	247	TS296XJSL	252	SSF84800	258	S1RSG	265
707HD	245	965HD	236	TS128XK	247	TS296XK	252	SSF8600	258	S1RSN	265
708HD	245	965SLHD	236	TS128XN	247	TS296XKSL	252	SSF93	257	S1RXC	266
721HD	245	966SLHD	236	TS128XN	247	TS296XN	252	SSF960	258	S1RXE	266
735HD	245	967HD	236	TS130	248	TS296XNSL	252	TS100	258	S1RXG	266
736HD	245	967SLHD	236	TS131	249	TS296XR	252	TS210	258	S1RXJ	266
745HD	245	968HD	236	TS132	249	TS296XRSL	252			S1RXK	266
752HD	245	969HD	246	TS132SL	249	TS572SL	234			S1RXN	266
818SL	249	971SLHD	236	TS137	249	TS704	251			S1RXR	266
818XC	247	978HD	246	TS1405SL	250	TS708	251			S1SA	265
818XCSSL	248	980HD	242	TS1408	250	TS752	251			S1SG	265
818XE	247	980HDXC	241	TS1411	251					S1SN	265
818XESL	248	980HDXE	241	TS198	249					S1XC	266
818XG	247	980HDXG	241	TS206	250					S1XE	266
818XGSL	248	980HDXJ	241	TS206XC	249					S1XG	266
818XJ	247	980HDXK	241	TS206XE	249					S1XJ	266
818XJSL	248	980HDXN	241	TS206XG	249					S1XK	266
818XK	247	980HDXR	241	TS206XJ	249					S1XN	266
818XKSL	248	982HD	242	TS206XK	249					S1XR	266
818XN	247	982HDXC	241	TS206XN	249					S2AX	264
818XNSL	248	982HDXE	241	TS206XR	249					S2CL	264
818XR	247	982HDXG	241	TS210	252					S2PB	264
818XRSL	248	982HDXJ	241	TS210SL	250					S2RS	264
8206XC	249	982HDXK	241	TS210XCSL	249					S2SG	264
8206XE	249	982HDXN	241	TS210XESL	249					S2SN	264
8206XG	249	982HDXR	241	TS210XGSL	249					S2XC	264
8206XJ	249	984HD	241	TS210XJSL	249					S2XE	264
8206XK	249	985HD	241	TS210XKSL	249					S2XG	264
8206XN	249	988HD	239	TS210XNSL	249					S2XJ	264
8206XR	249	989HD	240	TS210XRSL	249					S2XK	264
828SL	248	991HD	238	TS236	252					S2XN	264
829SL	248	996HD	239								

S2XR	264	S5XK	269	S811LXG	270	S83AX	264	S85RXC	269	S8RBPB	267
S4570SL	271	S5XKSL	272	S811LXJ	270	S83CL	264	S85RXE	269	S8RXC	270
S4AX	268	S5XN	269	S811LXK	270	S83PB	264	S85RXG	269	S8RXE	270
S4AXSL	272	S5XNSL	272	S811LXN	270	S83RS	264	S85RXJ	269	S8RXG	270
S4CL	269	S5XR	269	S811LXR	270	S83SG	264	S85RXK	269	S8RXJ	270
S4CLSL	272	S5XRSL	272	S811PB	267	S83SN	264	S85RXN	269	S8RXK	270
S4LAX	268	S601SL	271	S811PBSL	271	S83XC	264	S85RXR	269	S8RXN	270
S4LCL	269	S601XCSSL	271	S811RAX	269	S83XE	264	S85XC	269	S8RXR	270
S4LPB	266	S601XESL	271	S811RCL	270	S83XG	264	S85XCSSL	272	S8XC	270
S4LXC	269	S601XGSL	271	S811RPB	267	S83XJ	264	S85XE	269	S8XE	270
S4LXE	269	S601XJSL	271	S811RXC	270	S83XK	264	S85XESL	272	S8XG	270
S4LXG	269	S601XKSL	271	S811RXE	270	S83XN	264	S85XG	269	S8XJ	270
S4LXJ	269	S601XNSL	271	S811RXG	270	S83XR	264	S85XGSL	272	S8XK	270
S4LXK	269	S601XRSL	271	S811RXJ	270	S84586SL	271	S85XJ	269	S8XN	270
S4LXN	269	S602SL	271	S811RXK	270	S84AX	268	S85XJSL	272	S8XR	270
S4LXR	269	S604SL	271	S811RXN	270	S84AXSL	272	S85XK	269	S9AX	268
S4PB	266	S6127SL	271	S811XR	270	S84CL	269	S85XKSL	272	S9AXSL	272
S4PBSL	271	S6130SL	271	S811XC	270	S84CLSL	272	S85XN	269	S9ACL	270
S4RAX	268	S6134SL	271	S811XCSSL	272	S84LAX	268	S85XNSL	272	S9CLSL	272
S4RCL	269	S6500SL	271	S811XE	270	S84LCL	269	S85XR	269	S9LAX	268
S4RPB	266	S81086SL	271	S811XESL	272	S84LPB	266	S85XRSL	272	S9LCL	270
S4RXC	269	S81086XCSSL	271	S811XG	270	S84LXC	269	S86500SL	271	S9LPB	267
S4RXE	269	S81086XESL	271	S811XGSL	272	S84LXE	269	S86AX	268	S9LXC	270
S4RXG	269	S81086XGSL	271	S811XJ	270	S84LXG	269	S86AXSL	271	S9LXE	270
S4RXJ	269	S81086XJSL	271	S811XJSL	272	S84LXJ	269	S86CL	269	S9LXG	270
S4RXK	269	S81086XKSL	271	S811XK	270	S84LXK	269	S86CLSL	272	S9LXJ	270
S4RXN	269	S81086XNSL	271	S811XKSL	272	S84LXN	269	S86LAX	268	S9LXK	270
S4RXR	269	S81086XRSL	271	S811XN	270	S84LXR	269	S86LCL	269	S9LXN	270
S4XC	269	S810AX	269	S811XNSL	272	S84PB	266	S86LPB	267	S9LXR	270
S4XCSSL	272	S810AXSL	272	S811XR	270	S84PBSL	271	S86LXC	269	S9PB	267
S4XE	269	S810CL	270	S811XRSL	272	S84RAX	268	S86LXE	269	S9PBBSL	271
S4XESL	272	S810CSSL	272	S81651SL	271	S84RCL	269	S86LXG	269	S9RAX	268
S4XG	269	S810LAX	269	S81AX	266	S84RBPB	266	S86LXJ	269	S9RCL	270
S4XGSL	272	S810LCL	270	S81BL	264	S84RXC	269	S86LXK	269	S9RPB	267
S4XJ	269	S810LPB	267	S81BS	264	S84RXE	269	S86LXN	269	S9RXC	270
S4XJSL	272	S810LXC	270	S81CL	266	S84RXG	269	S86LXR	269	S9RXC	270
S4XK	269	S810LXE	270	S81LAX	266	S84RXJ	269	S86PB	267	S9RXC	270
S4XKSL	272	S810LXG	270	S81LBL	264	S84RXK	269	S86PBSL	271	S9RXE	270
S4XN	269	S810LXJ	270	S81LBS	264	S84RXN	269	S86RAX	268	S9RXJ	270
S4XNSL	272	S810LXK	270	S81LCL	266	S84RXR	269	S86RCL	269	S9RXK	270
S4XR	269	S810LXN	270	S81LPB	266	S84XC	269	S86RCL	269	S9RXN	270
S4XRSL	272	S810LXR	270	S81LRS	265	S84XCSSL	272	S86RPB	267	S9RXR	270
S572SL	271	S810PB	267	S81LSA	265	S84XE	269	S86RXC	269	S9XCSSL	272
S5AX	268	S810PBSL	271	S81LSG	265	S84XESL	272	S86RXG	269	S9XE	270
S5AXSL	272	S810RAX	269	S81LXC	266	S84XG	269	S86RXJ	269	S9XESL	272
S5CL	269	S810RCL	270	S81LXE	266	S84XGSL	272	S86RXK	269	S9XG	270
S5CLSL	272	S810RPB	267	S81LXG	266	S84XJ	269	S86RXN	269	S9XGSL	272
S5LAX	268	S810RXC	270	S81LXJ	266	S84XJSL	272	S86RXR	269	S9XJ	270
S5LCL	269	S810RXE	270	S81LXK	266	S84KK	269	S86XC	269	S9XJSL	272
S5LPB	266	S810RXG	270	S81LXN	266	S84KSL	272	S86XCSSL	272	S9XK	270
S5LXC	269	S810RXJ	270	S81LXR	266	S84XN	269	S86XE	269	S9XKSL	272
S5LXE	269	S810RXK	270	S81PB	266	S84XNSL	272	S86XESL	272	S9XN	270
S5LXG	269	S810RXN	270	S81RAX	266	S84XR	269	S86XG	269	S9XNSL	272
S5LXJ	269	S810RXX	270	S81RBL	265	S84XRSL	272	S86XGSL	272	S9XR	270
S5LXK	269	S810XC	270	S81RBS	264	S8572SL	271	S86XJ	269	S9XRSL	272
S5LXN	269	S810XCSSL	272	S81RCL	266	S85927SL	271	S86XJSL	272		
S5LXR	269	S810XE	270	S81RPB	266	S85931SL	271	S86XK	269		
S5PB	267	S810XESL	272	S81RRS	266	S85932SL	271	S86XKSL	272		
S5PBBSL	271	S810XG	270	S81RS	265	S85AX	268	S86XN	269		
S5RAX	268	S810XGSL	272	S81RSA	265	S85AXSL	272	S86XNSL	272		
S5RCL	269	S810XJ	270	S81RSG	265	S85CL	269	S86XR	269		
S5RPB	267	S810XJSL	272	S81RXC	266	S85CLS	272	S86XRSL	272		
S5RXC	269	S810XK	270	S81RXE	266	S85LAX	268	S8AX	268		
S5RXE	269	S810XKSL	272	S81RXG	266	S85LCL	269	S8CL	270		
S5RXG	269	S810XN	270	S81RXJ	266	S85LPB	266	S8LAX	268		
S5RXJ	269	S810XNSL	272	S81RXK	266	S85LXC	269	S8LCL	270		
S5RXK	269	S810XR	270	S81RXX	266	S85LXE	269	S8LPB	267		
S5RXN	269	S810XRSL	272	S81RXX	266	S85LXG	269	S8LXC	270		
S5RXR	269	S811AX	269	S81SA	265	S85LXJ	269	S8LXE	270		
S5XC	269	S811AXSL	272	S81SG	265	S85LXK	269	S8LXG	270		
S5XCSSL	272	S811CL	270	S81XC	266	S85LXN	269	S8LXJ	270		
S5XE	269	S811CLS	272	S81XE	266	S85LXR	269	S8LXK	270		
S5XESL	272	S811LAX	269	S81XG	266	S85PB	267	S8LXN	270		
S5XG	269	S811LCL	270	S81XJ	266	S85PBSL	271	S8LXR	270		
S5XGSL	272	S811LPB	267	S81XK	266	S85RAX	268	S8PB	267		
S5XJ	269	S811LXC	270	S81XN	266	S85RCL	269	S8RAX	268		
S5XJSL	272	S811LXE	270	S81XR	266	S85RPB	267	S8RCL	270		



Top: Pulse Linea, Geometric Glass with Flat Lite Frame, Doors – FCM81RXG, FCM81LXG
Bottom: Pulse Ari, Pembridge Glass with Flat Lite Frame, Door – S83PB



314 Top Left: Classic Craft Mahogany Grain, Augustine Glass, Door – CCR20527; Granite Glass, Sidelite – CCR3400XNSL, Finish – Driftwood
Bottom: Smooth-Star, Clear Glass with GBGs, Door – S1211, Sidelites – S1211SL, Finish – Granite

Tools of the Trade

Check out these helpful resources for dealers, builders and remodelers.

Architectural Home Styles Guide

Get inspired to choose entry doors by design with our interactive guide to popular home styles at thermatru.com/inspiration.



Education Center

Learn from the experts in fiberglass doors and test your door IQ on a variety of topics at thermatru.com/learning.



Certified Door System Installation Program

Build your knowledge, skills and confidence with comprehensive door system installer training from Therma-Tru – the expert in fiberglass door systems – and OSI® – the expert in construction sealants. Get started today at thermatru.com/installer.



Digital Vault

Explore the Digital Vault to find logos, images, literature and more to help you promote the Therma-Tru products you offer. Create an account today at thermatru.widencollective.com/login.



Trade Professionals Online

Find everything from selling tools and training materials to technical information at thermatru.com/professionals.





THERMA-TRU[®] DOORS

Where Home Begins[™]

thermatru.com

1-800-THERMA-TRU (843-7628)

1750 Indian Wood Circle

Maumee, OH 43537



#thermatru

Boise, ID
Bozeman, MT
Denver, CO
Ontario, CA
Phoenix, AZ
Sacramento, CA
Salt Lake City, UT
Spokane, WA
Tacoma, WA
Wilsonville, OR



www.orepac.com

Cover: Classic Craft Mahogany Grain, Low-E Glass with SDLs, Doors – CCM82804, Finish – Driftwood
Top: Classic Craft Fir Grain, Low-E Glass, Doors – CCA82400, Finish – Acorn, Retractable Screens – White

©2022 Therma-Tru Corp. All rights reserved. THERMA-TRU and the Therma-Tru Logo are trademarks of Therma-Tru Corp. Registered trademarks are registered in the U.S. and may be registered internationally.

©2022 Larson Manufacturing Company. All rights reserved. LARSON, QUICKFIT and CLICK&HOLD are trademarks of Larson Manufacturing Company.

Therma-Tru Corp. and Larson Manufacturing Company are part of Fortune Brands Home & Security, Inc. – an industry-leading home and security products company. ENERGY STAR is a government program that helps consumers protect the environment through superior energy efficiency and is a registered trademark of the U.S. Department of Energy and the U.S. Environmental Protection Agency.

Part #MAFL2022 HESB / JAN 2022